

XYPEX[®] Concrete Waterproofing
by Crystallization[™]





XYPEX[®]

CONCRETE WATERPROOFING BY CRYSTALLIZATION[™]

Copyright © 2010, 2012, 2013, 2017 Xypex Chemical Corporation. All rights reserved.

All content in this manual, including but not limited to text, graphics, images, and compilation of information, is the property of Xypex Chemical Corporation or its content suppliers, and is protected by United States, Canadian and international copyright laws.

The specifications and information regarding the products in this manual are subject to change without notice.

XYPEX, XYPEX, and Xypex “Concrete Waterproofing by Crystallization”, are registered trademarks of Xypex Chemical Corporation (“Xypex”). All other trademarks, logos and service marks shown in this manual, whether registered or unregistered, are the property of Xypex or their respective owners.

XYPEX CHEMICAL CORPORATION

13731 Mayfield Place, Richmond, BC, Canada V6V 2G9
Tel: 604.273.5265 Email: enquiry@xypex.com Web: www.xypex.com





TABLE OF CONTENTS

Xypex Overview	Page
Our Company	1
Crystalline Technology	2
The Products	3
Being Green	4
1.0 Products	Section
Product Overview	1.1
Technical Data Sheets.....	1.2
Method Statements	1.3
Estimating Table & Application Tools.....	1.4
Frequently Asked Questions	1.5
2.0 Specifications	Section
CSI Format	2.1
Coating Schematic Drawings	2.2
Admix Schematic Drawings.....	2.3
3.0 Tests & Approvals	Section
Test Reports	3.1
Approvals	3.2
4.0 Projects	Section
Wastewater Treatment Plants	4.1
Water Treatment Plants.....	4.2
Water Holding Structures	4.3
Below Grade.....	4.4
Tunnels.....	4.5
Bridges	4.6
Marine Structures	4.7
Dams	4.8
Power & Utilities	4.9
Precast	4.10

Our Company

Xypex Chemical Corporation is one of the world's leading manufacturers of products for the waterproofing, protection and repair of concrete structures.

In 1968 Xypex fundamentally changed and improved the approach to concrete waterproofing and protection, introducing Xypex Crystalline Technology, a chemistry designed to work within the concrete itself instead of simply on its surface.

The Xypex family of products evolved around varied applications of this unique technology and its ability to solve problems in situations where traditional barrier systems are weak or ineffective.

Xypex's global presence and commitment to excellence is bolstered by a strong network of licensees, distributors, technical representatives and installers who respond quickly to the needs and expectations of customers.



Crystalline Technology

It has been over 40 years since Xypex Chemical Corporation first coined the phrase “Concrete Waterproofing by Crystallization”, a statement and concept that represented a radical departure from traditional surface-reliant barrier products of the day.

Pursuing an entirely new path, Xypex developed a unique technology that takes advantage of the natural and porous characteristics of concrete.

With water as the catalyst, Xypex’s proprietary chemicals react with the natural by-products of cement hydration, forming a non-soluble crystalline structure within the inter-connected pores and other voids in the concrete.

In this way, the crystalline formation becomes a permanent, integral part of the concrete matrix itself, preventing the ingress of water and other liquids even under strong hydrostatic pressure, and providing protection against harsh, aggressive environments.

**NO
EQUAL**

5000x Magnification

After 26 Days



CONCRETE (UNTREATED)



XYPEX CRYSTALLIZATION (INITIATION)



XYPEX CRYSTALLIZATION (MATURE)

The Products

The Xypex product line has earned a solid reputation in the world of concrete waterproofing, protection and repair. Varying construction practices, divergent global environments, and specific customer requirements are all challenges that have helped shape and design a product selection whose scope, versatility and proven performance is recognized by architects, engineers and contractors worldwide.

The Xypex crystalline product line includes surface-applied coatings, additives for cast-in-place, shotcrete and precast concrete, and dry-shakes for freshly poured slabs. Together with supplemental repair and restoration materials, the versatile Xypex product line is a proven asset in the value engineering process.

Customer confidence in Xypex products is further supported by extensive and continual independent testing, numerous approvals and certifications, a myriad of successful projects and a comprehensive and diversified technical support network.



Being Green

Xypex is committed to the challenge of making an important contribution to reducing negative impacts on our climate and natural environment. Green buildings help to protect valuable natural resources and improve our general quality of life.

Having a global presence for over half a century has provided us with an understanding of environmental standards and expectations, and we are proud of our position and contribution. We continue to support LEED and other green building rating systems that reinforce product quality, corporate responsibility and today's environmental concerns.

To Xypex, Being Green is an ongoing commitment. Extending the service life of concrete structures, providing energy efficiency, minimizing site impact, reducing VOCs and using materials that are non-toxic, ethical and sustainable – these are the 'green' benefits that Xypex products provide to the construction world and the pursuit of environmental sustainability.



Section	Page
Coating System	
Concentrate	1
Modified	1
Additive Series	
Admix C-500/C-500 NF	2
Admix C-1000/C-1000 NF	2
Admix C-2000/C-2000 NF	2
Admix C-1000 Red	2
Dry Shake Series	
Concentrate DS-1	3
Concentrate DS-2	3
Repair & Accessories	
Patch'n Plug	4
Megamix I and II	4
Restora-Top 50, 100, 200	5
FCM 80	5
Gamma Cure	5
Xycrylic Admix	6
Quickset	6

COATING SYSTEM



Coating Products

Xypex Coating products, for surface application, are part of the Xypex concrete waterproofing and protection system and represent one of three different ways to install Xypex Crystalline Technology into concrete.



Concentrate

Xypex Concentrate is applied as a cementitious slurry to the surface of existing above or below-grade structures to waterproof and protect the concrete against high hydrostatic pressure and aggressive environments.

- apply with a semi-stiff nylon bristle brush or spray machine
- also mixed in Dry-Pac form for sealing construction joints and repairing cracks and tie-holes

Packaging

Pails: 20 lb. (9.1 kg) and 60 lb. (27.2 kg)
 Bags: 50 lb. (22.7 kg)



Modified

Xypex Modified can be applied as a second coat to chemically reinforce Concentrate, or as a single coat for the damp-proofing of exterior foundation walls.

- as a second coat, apply after the Concentrate coating has reached an initial set but while it is still “green” (less than 48 hours)
- produces a harder finish

Packaging

Pails: 60 lb. (27.2 kg)
 Bags: 50 lb. (22.7 kg)



Additive Products

Xypex Additive products, added to the concrete at time of batching, are part of the Xypex concrete waterproofing and protection system and represent one of three different ways to install Xypex Crystalline Technology into concrete.

Admix C-500/C-500 NF, C-1000/C-1000 NF, C-2000/C-2000 NF, C-1000 Red

All variations of the Admix C-Series contain the same amount of reactive chemicals at their prescribed dosage rates and provide comparable waterproofing and durability performance characteristics. Xypex Admix C-Series is available in regular or no-fines grades (NF) and has been formulated to satisfy the requirements of diverse concrete mix designs, differences in project requirements and ambient temperature variations. Admix C-1000 Red contains a red oxide pigment as a quality assurance measure for precasters.

- installation methods: cast-in-place, shotcrete, precast
- convenient, cost-effective
- increases flexibility in construction scheduling

Packaging

The Admixes are supplied in a variety of types of packages to satisfy customer or project requirements. Admix C-500/C-500 NF and C-1000/C-1000 NF are available in various conveniently sized soluble bags to meet specific batching requirements; they enhance quality control, eliminate dust during handling and the cartons are recyclable.



DRY SHAKE SERIES

Dry Shake Products

Xypex Dry Shake products, for horizontal surfaces, are part of the Xypex concrete waterproofing and protection system and represent one of three different ways to install Xypex Crystalline Technology into concrete.



Concentrate DS-1

Xypex DS-1 is a special dry shake formulation of Xypex Concentrate and is designed specifically for horizontal concrete surfaces such as parking decks and floor slabs. DS-1 is trowelled into fresh concrete prior to finishing.

- applied by hand or mechanical spreader
- reduces the risk of scaling, dusting and delamination that is typically associated with coatings applied to a slab's surface

Packaging

Pails: 60 lb. (27.2 kg)



Concentrate DS-2

Xypex DS-2, like DS-1, is also designed for horizontal concrete surfaces but is used where, in addition to waterproofing, greater resistance to abrasion is required.

- applied by hand or mechanical spreader
- increases abrasion resistance

Packaging

Pails: 60 lb. (27.2 kg)



Concrete Repair & Accessory Products

Xypex provides a number of specialized products for a wide range of concrete repair applications such as stopping flowing water, patching, resurfacing, and rehabilitating concrete as well as the repairing of defects.



Patch'n Plug

Xypex Patch'n Plug is formulated as a crystalline, fast-setting hydraulic cement compound for concrete patching and repair. It stops flowing water in seconds and is used to seal cracks, fill tie-holes and other defects in concrete.

- fast-setting, non-shrinking
- high bond strength

Packaging

Pails: 20 lb. (9.1 kg), 60 lb. (27.2 kg)



Megamix I and II

Xypex Megamix I is a thin parge coat for the waterproofing and resurfacing of vertical masonry or concrete surfaces, as a cap coat for Xypex Concentrate, or as an architectural rendering. Megamix II is a thick repair mortar for the patching and resurfacing of deteriorated concrete. Megamix products are enhanced by Xypex's unique crystalline waterproofing and protection technology.

- superior bonding
- chemical durability
- high strength

Packaging

Megamix I: 60 lb. (27.2 kg) pails

Megamix II: 55 lb. (25 kg) bags

REPAIR & ACCESSORIES

Restora-Top 50, 100, 200



Xypex Restora-Top products are designed specifically for the repair and rehabilitation of horizontal concrete surfaces such as warehouse floors, decks, curbs, and walkways where the repaired area must be returned to normal service within two to four hours of the completed repair.

- rapid setting and strength gain
- excellent adhesion, superior durability

Packaging

Pails: 55 lb. (25 kg)

FCM 80



Xypex FCM is designed for repairing cracks subject to movement, sealing construction joints, restoring deteriorated concrete and waterproofing concrete structures. FCM is a two component product consisting of a liquid polymer dispersion and a cementitious powder.

- exceptional adhesive and elongation characteristics
- often used in conjunction with the Xypex Crystalline Concrete Waterproofing System

Packaging

FCM 80 is available in a carton as a unit (kit), which includes:
1.06 gal. (4 litre) bottle, 22 lb. (10 kg) pail

Gamma Cure



Xypex Gamma Cure is a curing agent designed specifically for Xypex crystalline waterproofing products. Gamma Cure acts as an evaporation retardant by retaining the maximum amount of moisture in the Xypex coating. It also provides a catalyst for the reaction with the Xypex crystalline waterproofing treatment.

- where water-curing is not possible
- vertical surfaces; hot, dry, windy conditions

Packaging

Bottles: 1 U.S. gal. (3.79 litres)
Pails: 5 U.S. gal. (18.95 litres)



Xycrylic Admix

Xycrylic Admix is a water-based polymer dispersion designed for fortifying Portland cement compositions. The liquid is milky-white in colour and has a high solids content. Can be used with Xypex Patch'n Plug and Megamix I to increase bond strength.

- enhances bond, reduces shrinkage cracking
- excellent water and weather resistance

Packaging

Bottles: 1 U.S. gal. (3.79 litres)

Pails: 5 U.S. gal. (18.95 litres)



Xypex Quickset

Xypex Quickset is a water-soluble liquid blend of silicates, neutralizers and penetrating agents specially compounded to harden, dustproof and seal the surfaces of fresh or newly cured concrete floors.

- enhances abrasion resistance
- recommended for concrete slabs where a hard, dustproof surface is required

Packaging

Bottles: 1 U.S. gal. (3.79 litres)

Pails: 5 U.S. gal. (18.95 litres)

Section	Page
Concentrate	1
Modified	5
Admix C-500/C-500 NF	9
Admix C-1000/C-1000 NF	13
Admix C-2000/C-2000 NF	17
Admix C-1000 Red	21
Concentrate DS-1	29
Concentrate DS-2	33
Patch'n Plug	37
Megamix I	39
Megamix II	41
Restora-Top 50	45
Restora-Top 100	47
Restora-Top 200	49
FCM 80	51
Gamma Cure	53
Xycrylic Admix	55
Quickset	57

Description

Xypex is a unique chemical treatment for the waterproofing, protection and repair of concrete. XYPEX CONCENTRATE consists of Portland cement, finely graded sand and active proprietary chemicals; it is applied as a cementitious slurry to the pre-saturated surface of existing above and below-grade structures. The active chemicals diffuse into the substrate and react with moisture and the constituents of hardened concrete to cause a catalytic reaction. This reaction generates a non-soluble crystalline formation throughout the pores and capillary tracts of the concrete, as well as cracks, permanently sealing the concrete and preventing the penetration of water and other liquids from any direction, even under high hydrostatic pressure. Xypex Concentrate is also mixed in a Dry-Pac form for sealing strips at construction joints, or for the repairing of leaking cracks, faulty construction joints and other defects.

Recommended for:

- Reservoirs
- Sewage and Water Treatment Plants
- Underground Vaults
- Secondary Containment Structures
- Foundations
- Tunnels and Subway Systems
- Swimming Pools
- Parking Structures

Advantages

- Resists extreme hydrostatic pressure
- Becomes an integral part of the substrate
- Can seal static hairline cracks up to 0.4 mm
- Can be applied to the positive or the negative side of the concrete surface
- Allows concrete to breathe
- Highly resistant to aggressive chemicals
- Non-toxic / no VOCs
- Does not require a dry surface
- Cannot puncture, tear or come apart at the seams
- No costly surface priming or leveling prior to application
- Does not require sealing, lapping and finishing of seams at corners, edges or between membranes
- Does not require protection during backfilling or during placement of steel, wire mesh or other materials
- Less costly to apply than most other methods
- Not subject to deterioration
- Permanent
- Available in white for enhanced illumination

Packaging

Xypex Concentrate is available in 20 lb. (9.1 kg) pails, 60 lb. (27.2 kg) pails and 50 lb. (22.7 kg) bags.

Storage

Xypex products must be stored dry at a minimum temperature of 45°F (7°C). Shelf life is one year when stored under proper conditions.

Coverage

For normal surface conditions, the coverage rate for each Xypex coat is 6 to 7.2 sq. ft./lb. (1.25 - 1.5 lb./sq.yd. or 0.65 - 0.8 kg/m²).

Test Data

PERMEABILITY

U.S. Army Corps of Engineers (USACE) CRD C48, "Permeability of Concrete", Pacific Testing Labs, Seattle, USA

Two in. (51 mm) thick, 2000 psi (13.8 MPa) Xypex-treated concrete samples were pressure tested up to a 405 ft. (124 m) water head (175 psi/1.2 MPa), the limit of the testing apparatus. While untreated samples showed marked leakage, the Xypex-treated samples (as a result of the crystallization process) became totally sealed and exhibited no measurable leakage.

DIN 1048 (equivalent to EN 12390-8), "Water Impermeability of Concrete", Bautest – Corporation for Research & Testing of Building Materials, Augsburg, Germany

Twenty cm thick Xypex-treated concrete samples were pressure tested up to 7 bars (230 ft./70 m water head) for 24 hours to determine water impermeability. While the reference specimens measured water penetration up to a depth of 92 mm, Xypex-treated samples measured water penetration of zero to an average of 4 mm.

EN 12390-8, "Depth of Water Penetration on Samples Treated with Concentrate Coating", OL-123, Czech Technical University, Prague, Czech Republic

Three replicate 150 mm concrete cubes from four different mix designs (strength classes) were coated with Xypex Concentrate at a thickness of 0.8 mm to 1 mm. Controls for each of the different mix designs were also cast for comparison purposes. All samples were exposed to 0.5 MPa (73 psi) of water pressure for 72 hours from the opposite side of the treated surface. Specimens from each set were split transversely from the treated surface at 28 and 91 days to measure depth of water penetration from the exposed surface. After 28 days, the Xypex coating re-

duced the depth of water penetration by 90 to 94% compared to the control mixes for the four mix types. At 91 days all Xypex-treated samples measured <1 mm of water penetration.

DEPTH OF PENETRATION

“Measurement of Mass Concrete Humidity”, Czech Technical University, (CVUT) Faculty of Civil Engineering, Prague, Czech Republic

A coating of Xypex Concentrate was applied to one face of a 300 mm x 300 mm x 220 mm set of concrete blocks; two replicate sets of blocks were left untreated. Water filled containers were tightly sealed onto the opposite face of the treated blocks and one set of the untreated blocks while the third untreated block set was kept in the laboratory as a control. Humidity probes were installed in 6 mm diameter holes that were drilled to within 30 - 40 mm of the water exposed surface. Mass humidity was recorded at intervals of 28, 45, 90, 125 and 132 days. Final results showed that the Xypex-treated specimens had an average humidity reading of 4.6%, the untreated sample measured 7.9% and the control block with no water exposure was 4.4%, essentially equivalent to the Xypex specimens' results. The Xypex reactive chemicals had diffused at least 190 mm in 132 days.

“An Enhancement in the Nature of Concrete with a Multiplicative Cement Crystal-Type Concrete Material”, Central Research Laboratory of Nikki Shoji in association with Hosei University, Japan



A 60 cm x 70 cm x 40 cm concrete block was cast and a Concentrate coating was applied to the surface and cured. The block was left outdoors for approximately 1 year. Subsequently, a 40 cm (15.75 in.) long cylinder was then cored perpendicular

to the Xypex treatment and cut into 18 slices of equal length. SEM photographs utilizing a 1000x magnification were taken of slices from various depths from the treated surface to determine the extent of crystalline growth. While the crystalline structure was most dense in specimens located closest to the treated surface, there was evidence of the crystalline structure at 30 cm (12 inches) from the treated surface.

CRACK SEALING

ASTM C856 “Standard Practice for Petrographic Examination of Hardened Concrete”, Setsco Services Pte, Ltd., Singapore

A coat of Xypex Concentrate was applied to a slab that had developed numerous hairline cracks. To determine the crack sealing ability of the Xypex treatment, cores were extracted from a slab at 3, 10, 14 and 20 days following application. Thin sections were taken from each core in order to examine hairline cracks utilizing a polarizing and fluorescent microscope (PFM). In each case,

there was evidence of the Xypex crystalline structure in the cracks to a depth of about 20 mm. Photographs taken this depth at 100x magnification showed the Xypex crystalline structure had reduced the width of the cracks dramatically.

TENSILE BOND STRENGTH

EN 1542 “Products and Systems for the Protection and Repair of Concrete Structures – Test Methods – Measurement by Pull-off”, Trow Associates Inc., Burnaby, B.C., Canada

Two coats of Xypex Concentrate were applied at 0.8 kg per m² with a total cured thickness of 0.9 mm to a standard concrete substrate meeting EN 1766 MC (0,40) (meeting ICRI CSP-4). The coating was applied and cured to the manufacturer's technical specifications and tested at 30 days age for bond strength. The average tensile bond strength of five replicates was 1.23 MPa.

CHEMICAL RESISTANCE

ASTM C 267, “Chemical Resistance to Mortars”, Pacific Testing Labs, Seattle, USA

Xypex-treated cylinders and untreated cylinders were exposed to hydrochloric acid, caustic soda, toluene, mineral oil, ethylene glycol, pool chlorine, brake fluid and other chemicals. Results indicated that chemical exposure did not have any detrimental effects on the Xypex coating. Tests following chemical exposure measured an average 17% higher compressive strength in the Xypex-treated specimens over the untreated control samples.

IWATE University Technical Report, “Resistance to Acid Attack”, Tokyo, Japan



Xypex-treated mortar and untreated mortar were measured for acid resistance after exposure to a 5% H₂SO₄ solution for 100 days. Xypex suppressed concrete erosion to 1/8 of the reference samples.

ASTM C876 “Influence of Xypex Coating System on Residual Service Life of Concrete Structures” Durability Assessment Section, Xypex Australia

A bridge pier exposed to seawater in a tidal splash zone for over 40 years experienced different types of deterioration mechanisms including surface abrasion (skin loss), cracking, and corrosion of steel reinforcement. Corrosion monitoring was conducted before and six months after application of Xypex Concentrate. This non-destructive testing (NDT) included a measurement of the corrosion rate, corrosion potential, and concrete resistivity. Results indicated a reduction of corrosion rate and corrosion potential up to 50% and 40% respectively, and significant enhancement of the concrete resistivity.

RILEM CPC-18 “Carbonation Resistance of Samples Treated with a Xypex Concentrate Coating”, Construction and Maintenance Technology Research Center (CONTEC), Sirindhorn International Institute of Technology (SIIT) – Thammasat University, Bangkok, Thailand

Control and Xypex Concentrate coated samples were carbonated in an accelerated carbonation chamber. The average depths of carbonation were measured at 28, 56, 77 and 91 days. The depth of carbonation of these Xypex Concentrate coated samples was reduced by 35 - 40% compared to the controls. Following initial carbonation, one set of samples was coated with Xypex Concentrate to model old concrete already damaged by carbonation. For these specimens, testing indicated that carbonation was arrested and in one specimen reduced.

FREEZE/THAW DURABILITY

ASTM C 672, “Standard Test Method for Scaling Resistance of Concrete Surfaces Exposed to De-Icing Chemicals”, Twin City Testing Lab, St. Paul, USA

Xypex-treated samples restricted chloride ion concentration to below the level necessary to promote electrolytic corrosion of reinforcing steel. Visual examination of untreated panels after 50 freeze/thaw cycles showed a marked increase in surface deterioration compared to Xypex-treated samples.

POTABLE WATER EXPOSURE

NSF 61, “Drinking Water System Component-Health Effects”, NSF International, Ann Arbor, USA

Exposure testing of potable water in contact with Xypex-treated samples indicated no harmful effects.

RADIATION RESISTANCE

U.S.A. Standard No. N69, “Protective Coatings for the Nuclear Industry”, Pacific Testing Labs, Seattle, USA

After exposure to 5.76×10^4 rads of gamma radiation, the Xypex treated specimens displayed no ill effects.

Application Procedures

1. SURFACE PREPARATION Concrete surfaces to be treated must be clean and free of laitance, dirt, film, paint, coating or other foreign matter. Surfaces must also have an open capillary system to provide “tooth and suction” for the Xypex treatment. A CSP-3 per the International Concrete Repair Institute Guidelines and Surface Profile Chips is recommended. If surface is too smooth (e.g. where steel forms are used) or covered with excess form oil or other foreign matter, the concrete should be lightly sandblasted, waterblasted, or etched with muriatic (HCL) acid.

2. STRUCTURAL REPAIRS – PRIOR TO COATING APPLICATION For cracks larger than 1/64” (0.4 mm) or for actively leaking cracks the following repair procedures are recommended. Chip out cracks, faulty construction joints

and other structural defects to a depth of 1.5 inches (37 mm) and a width of 1 inch (25 mm). A “V” shaped slot is not acceptable. The slot may be saw cut instead of chipped but ensure that the slot is dovetailed or otherwise shaped such that there will be mechanical interlock of materials placed into the slot at a later stage. Clean and wet the slot and apply a brush coat of Xypex Concentrate as described in steps 5 & 6 and allow to dry for 10 minutes. Fill cavity by tightly compressing Dry-Pac into the groove with pneumatic packing tool or with hammer and wood block.

Note:

- i. Areas of poor concrete consolidation that show evidence of leakage should also be repaired.
- ii. Against a direct flow of water (leakage) or where there is excess moisture due to seepage, use Xypex Patch'n Plug, then Xypex Dry-Pac followed by a brush coat of Xypex Concentrate.
- iii. For expansion joints or chronic moving cracks, flexible materials such as expansion joint sealants should be used.

3. WETTING CONCRETE Xypex requires a saturated surface dry (SSD) condition. Concrete surfaces must be thoroughly saturated with clean water prior to the application so as to aid the diffusion of the Xypex chemistry and to ensure growth of the crystalline formation deep within the pores of the concrete. Remove excess water before the application such that there is no glistening water on the surface. If concrete dries out before application, it must be re-wetted.

4. MIXING FOR SLURRY COAT Mix Xypex powder with clean water to a creamy consistency in the following proportions:

For Brush Application

1.25 - 1.5 lb./sq. yd. (0.65 - 0.8 kg/m²)
5 parts powder to 2 parts water

2.0 lb./sq. yd. (1.0 kg/m²)

3 parts powder to 1 part water

For Spray Application

1.25 - 1.5 lb./sq. yd. (0.65 - 0.8 kg/m²)
5 parts powder to 3 parts water
(ratio may vary with equipment type)

Do not mix more Xypex material than can be applied in 20 minutes. As the mixture thickens, stir briefly to ensure mixture remains fluid; but do not add water.

Mixing Dry-Pac

Using a trowel, mix 6 parts Xypex Concentrate powder by volume to 1 part clean water for 10 to 15 seconds. Lumps should be present in this mixture. Do not mix more than can be applied in 20 minutes.

5. APPLYING XYPEX Apply Xypex with a semi-stiff nylon bristle brush, push broom (for large horizontal surfaces) or specialized spray equipment. The coating must be uniformly applied and should be just under 1/16 in. (1.25 mm). When a second coat (Xypex Concentrate or Xypex Modified) is required, it should be applied after the first coat has reached an initial set but while it is still “green” (less than 48 hours). Curing by misting the coating with water should be done between coats. Ensure first coat is in SSD condition before application of the second coat. The Xypex treatment must not be applied under rainy conditions or when ambient temperature is below 40°F (4°C). Avoid application of the Xypex coating in hot and windy conditions as the coating may dry out prematurely. For recommended equipment, contact Xypex’s Technical Services Department or your local Xypex Technical Services Representative.

6. CURING Generally a misty fog spray of clean water is used for curing the Xypex treatment. Curing should begin as soon as the Xypex has set to the point where it will not be damaged by a fine spray of water. Under normal conditions, it is sufficient to spray Xypex-treated surfaces three times per day for two to three days. In hot or arid climates, spraying may be required more frequently. Wet burlap and some specialty curing blankets are also effective for curing. During the curing period, the coating must be protected from rainfall, frost, wind, the puddling of water and temperatures below 36°F (2°C) for a period of not less than 48 hours after application. If plastic sheeting is used as protection, it must be raised off the Xypex to allow the coating to breathe. Xypex Gamma Cure may be used in lieu of water curing for certain applications, consult with Xypex’s Technical Services Department or your local Xypex Technical Services Representative.

Note:

- i. For concrete structures that hold liquids (e.g. reservoirs, swimming pools, tanks, etc.), Xypex should be cured for three days and allowed to set for 12 days (18 days for waste water or corrosive solutions) before filling the structure with liquid.
- ii. For Xypex coated slabs that will be a wearing surface, an application of Xypex Quickset after the coating has been cured and dried is recommended. Contact your local Xypex Technical Services Representative for assistance.
- iii. If any other cementitious system is applied over the Xypex coating, it should be after the coating has completely set but while it is still green (12 to 48 hours); the 12 to 24 hour window is considered ideal. For installations onto a Xypex coating older than 48 hours contact your local Xypex Technical Services Representative regarding surface preparation and application recommendations. Xypex Chemical Corporation makes no representations or warranties regarding the compatibility of Xypex prod-

ucts with plasters, stuccos, tiles and other surface-applied materials. Prior to the installation, it is recommended that a test section be completed under anticipated ambient and project conditions to demonstrate acceptable bond.

Technical Services

For more instructions, alternative installation methods, or information concerning the compatibility of the Xypex treatment with other products or technologies, contact the Technical Services Department of Xypex Chemical Corporation or your local Xypex Technical Services Representative.

Certification

Xypex Concentrate satisfies the requirements of EN 1504-2; Initial Type Testing (ITT) according to EN 1504-2 was certified by BSI as the Notifying Body.

Safe Handling Information

Xypex is alkaline. As a cementitious powder or mixture, Xypex may cause significant skin and eye irritation. Directions for treating these problems are clearly detailed on all Xypex pails and packaging. The Manufacturer also maintains comprehensive and up-to-date Safety Data Sheets on all its products. Each sheet contains health and safety information for the protection of workers and customers. The Manufacturer recommends you contact Xypex Chemical Corporation or your local Xypex Technical Services Representative to obtain copies of Safety Data Sheets prior to product storage or use.

Warranty

The Manufacturer warrants that the products manufactured by it shall be free from material defects and will be consistent with its normal high quality. Should any of the products be proven defective, the liability to the Manufacturer shall be limited to replacement of the product ex factory. The Manufacturer makes no warranty as to merchantability or fitness for a particular purpose and this warranty is in lieu of all other warranties expressed or implied. The user shall determine the suitability of the product for his intended use and assume all risks and liability in connection therewith.

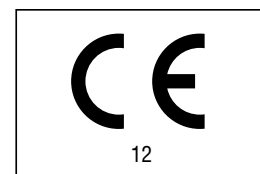

Description

Xypex is a unique chemical treatment for the waterproofing, protection and repair of concrete. XYPEX MODIFIED can be applied as a second coat to reinforce Xypex Concentrate, or applied by itself to damp-proof the exterior of foundation walls. Applied as a second coat, Xypex Modified chemically reinforces Xypex Concentrate where two coats are required and produces a harder finish. Where damp-proofing is required, a single coat of Modified may be used as an alternative to a spray / tar emulsion. Xypex prevents the penetration of water and other liquids from any direction by causing a catalytic reaction that produces a non-soluble crystalline formation within the pores and capillary tracts of concrete and cement-based materials.

Recommended for:

Xypex Modified is recommended as a single coat for the damp-proofing of foundations or as a second coat with Xypex Concentrate for the following applications:

- Reservoirs
- Sewage and Water Treatment Plants
- Secondary Containment Structures
- Tunnels and Subway Systems
- Underground Vaults
- Foundations
- Parking Structures
- Swimming Pools

Advantages

- Resists extreme hydrostatic pressure
- Becomes an integral part of the substrate
- Can seal static hairline cracks up to 0.4 mm
- Can be applied to the positive or the negative side of the concrete surface
- Allows concrete to breathe
- Highly resistant to aggressive chemicals
- Non-toxic / no VOCs
- Does not require a dry surface
- Cannot puncture, tear or come apart at the seams
- No costly surface priming or leveling prior to application
- Does not require sealing, lapping and finishing of seams at corners, edges or between membranes
- Does not require protection during backfilling or during placement of steel, wire mesh or other materials
- Less costly to apply than most other methods
- Not subject to deterioration
- Permanent
- Available in white for enhanced illumination

Packaging

Xypex Modified is available in 60 lb. (27.2 kg) pails and 50 lb. (22.7 kg) bags.

Storage

Xypex products must be stored dry at a minimum temperature of 45°F (7°C). Shelf life is one year when stored under proper conditions.

Coverage

For normal surface conditions, the coverage rate for each coat is 6 - 7.2 sq. ft. per lb. (1.25 - 1.5 lb. per sq. yd. or 0.65 - 0.8 kg/m²).

Test Data

When used in conjunction with Xypex Concentrate:

PERMEABILITY

U.S. Army Corps of Engineers (USACE) CRD C48, "Permeability of Concrete", Pacific Testing Labs, Seattle, USA

Two in. (51 mm) thick, 2000 psi (13.8 MPa) Xypex-treated concrete samples were pressure tested up to a 405 ft. (124 m) water head (175 psi/1.2 MPa), the limit of the testing apparatus. While untreated samples showed marked leakage, the Xypex-treated samples (as a result of the crystallization process) became totally sealed and exhibited no measurable leakage.

DIN 1048 (equivalent to EN 12390-8), "Water Impermeability of Concrete", Bautest – Corporation for Research & Testing of Building Materials, Augsburg, Germany

Twenty cm thick Xypex-treated concrete samples were pressure tested up to 7 bars (230 ft./70 m water head) for 24 hours to determine water impermeability. While the reference specimens measured water penetration up to a depth of 92 mm, Xypex-treated samples measured water penetration of zero to an average of 4 mm.

EN 12390-8, "Depth of Water Penetration on Samples Treated with Concentrate Coating", OL-123, Czech Technical University, Prague, Czech Republic

Three replicate 150 mm concrete cubes from four different mix designs (strength classes) were coated with Xypex Concentrate at a thickness of 0.8 mm to 1 mm. Controls for each of the different mix designs were also cast for comparison purposes. All samples were exposed to 0.5 MPa (73 psi) of water pressure for 72 hours from the opposite side of the treated surface. Specimens from each set were split transversely from the treated surface at 28 and 91 days to measure depth of water

penetration from the exposed surface. After 28 days, the Xypex coating reduced the depth of water penetration by 90 to 94% compared to the control mixes for the four mix types. At 91 days all Xypex-treated samples measured <1 mm of water penetration.

DEPTH OF PENETRATION

“Measurement of Mass Concrete Humidity”, Czech Technical University, (CVUT) Faculty of Civil Engineering, Prague, Czech Republic

A coating of Xypex Concentrate was applied to one face of a 300 mm x 300 mm x 220 mm set of concrete blocks; two replicate sets of blocks were left untreated. Water filled containers were tightly sealed onto the opposite face of the treated blocks and one set of the untreated blocks while the third untreated block set was kept in the laboratory as a control. Humidity probes were installed in 6 mm diameter holes that were drilled to within 30 - 40 mm of the water exposed surface. Mass humidity was recorded at intervals of 28, 45, 90, 125 and 132 days. Final results showed that the Xypex-treated specimens had an average humidity reading of 4.6%, the untreated sample measured 7.9% and the control block with no water exposure was 4.4%, essentially equivalent to the Xypex specimens' results. The Xypex reactive chemicals had diffused at least 190 mm in 132 days.

“An Enhancement in the Nature of Concrete with a Multiplicative Cement Crystal-Type Concrete Material”, Central Research Laboratory of Nikki Shoji in Association with Hosei University, Japan



A 60 cm x 70 cm x 40 cm concrete block was cast and a Concentrate coating was applied to the surface and cured. The block was left outdoors for approximately 1 year. Subsequently, a 40 cm (15.75 in.) long cylinder was then cored perpendicular

to the Xypex treatment and cut into 18 slices of equal length. SEM photographs utilizing a 1000x magnification were taken of slices from various depths from the treated surface to determine the extent of crystalline growth. While the crystalline structure was most dense in specimens located closest to the treated surface, there was evidence of the crystalline structure at 30 cm (12 inches) from the treated surface.

CRACK SEALING

ASTM C856 “Standard Practice for Petrographic Examination of Hardened Concrete”, Setsco Services Pte, Ltd., Singapore

A coat of Xypex Concentrate was applied to a slab that had developed numerous hairline cracks. To determine the crack sealing ability of the Xypex treatment, cores were extracted from a slab at 3, 10, 14 and 20 days following application. Thin sections were taken from each core in order to examine hairline cracks utilizing a polarizing and fluorescent microscope (PFM). In each case,

there was evidence of the Xypex crystalline structure in the cracks to a depth of about 20 mm. Photographs taken this depth at 100x magnification showed the Xypex crystalline structure had reduced the width of the cracks dramatically.

TENSILE BOND STRENGTH

EN 1542 “Products and Systems for the Protection and Repair of Concrete Structures – Test Methods – Measurement by Pull-off”, Trow Associates Inc., Burnaby, B.C., Canada

Two coats of Xypex Concentrate were applied at 0.8 kg per m² with a total cured thickness of 0.9 mm to a standard concrete substrate meeting EN 1766 MC (0,40) (meeting ICRI CSP-4). The coating was applied and cured to the manufacturer's technical specifications and tested at 30 days age for bond strength. The average tensile bond strength of five replicates was 1.23 MPa.

CHEMICAL RESISTANCE

ASTM C 267, “Chemical Resistance to Mortars”, Pacific Testing Labs, Seattle, USA

Xypex-treated cylinders and untreated cylinders were exposed to hydrochloric acid, caustic soda, toluene, mineral oil, ethylene glycol, pool chlorine, brake fluid and other chemicals. Results indicated that chemical exposure did not have any detrimental effects on the Xypex coating. Tests following chemical exposure measured an average 17% higher compressive strength in the Xypex-treated specimens over the untreated control samples.

IWATE University Technical Report, “Resistance to Acid Attack”, Tokyo, Japan



Before Immersion After 5 Weeks After 10 Weeks

Xypex-treated mortar and untreated mortar were measured for acid resistance after exposure to a 5% H₂SO₄ solution for 100 days. Xypex suppressed concrete erosion to 1/8 of the reference samples.

ASTM C876 “Influence of Xypex Coating System on Residual Service Life of Concrete Structures” Durability Assessment Section, Xypex Australia

A bridge pier exposed to seawater in a tidal splash zone for over 40 years experienced different types of deterioration mechanisms including surface abrasion (skin loss), cracking, and corrosion of steel reinforcement. Corrosion monitoring was conducted before and six months after application of Xypex Concentrate. This non-destructive testing (NDT) included a measurement of the corrosion rate, corrosion potential, and concrete resistivity. Results indicated a reduction of corrosion rate and corrosion potential up to 50% and 40% respectively, and significant enhancement of the concrete resistivity.

RILEM CPC-18 “Carbonation Resistance of Samples Treated with a Xypex Concentrate Coating”, Construction and Maintenance Technology Research Center (CONTEC), Sirindhorn International Institute of Technology (SIIT) – Thammasat University, Bangkok, Thailand

Control and Xypex Concentrate coated samples were carbonated in an accelerated carbonation chamber. The average depths of carbonation were measured at 28, 56, 77 and 91 days. The depth of carbonation of these Xypex Concentrate coated samples was reduced by 35 - 40% compared to the controls. Following initial carbonation, one set of samples was coated with Xypex Concentrate to model old concrete already damaged by carbonation. For these specimens, testing indicated that carbonation was arrested and in one specimen reduced.

FREEZE/THAW DURABILITY

ASTM C 672, “Standard Test Method for Scaling Resistance of Concrete Surfaces Exposed to De-Icing Chemicals”, Twin City Testing Lab, St. Paul, USA

Xypex-treated samples restricted chloride ion concentration to below the level necessary to promote electrolytic corrosion of reinforcing steel. Visual examination of untreated panels after 50 freeze/thaw cycles showed a marked increase in surface deterioration compared to Xypex-treated samples.

POTABLE WATER EXPOSURE

NSF 61, “Drinking Water System Component-Health Effects”, NSF International, Ann Arbor, USA

Exposure testing of potable water in contact with Xypex-treated samples indicated no harmful effects.

RADIATION RESISTANCE

U.S.A. Standard No. N69, “Protective Coatings for the Nuclear Industry”, Pacific Testing Labs, Seattle, USA

After exposure to 5.76×10^4 rads of gamma radiation, the Xypex treated specimens displayed no ill effects.

Application Procedures

1. SURFACE PREPARATION Concrete surfaces to be treated must be clean and free of laitance, dirt, film, paint, coating or other foreign matter. Surfaces must also have an open capillary system to provide “tooth and suction” for the Xypex treatment. A CSP-3 per the International Concrete Repair Institute Guidelines and Surface Profile Chips is recommended. If surface is too smooth (e.g. where steel forms are used) or covered with excess form oil or other foreign matter, the concrete should be lightly sandblasted, waterblasted, or etched with muriatic (HCL) acid.

2. STRUCTURAL REPAIRS – PRIOR TO COATING APPLICATION For cracks larger than 1/64” (0.4 mm) or for actively leaking cracks the following repair procedures are recommended. Chip out cracks, faulty construction

joints and other structural defects to a depth of 1.5 inches (37 mm) and a width of 1 inch (25 mm). A “V” shaped slot is not acceptable. The slot may be saw cut instead of chipped but ensure that the slot is dovetailed or otherwise shaped such that there will be mechanical interlock of materials placed into the slot at a later stage. Clean and wet the slot and apply a brush coat of Xypex Concentrate as described in steps 5 & 6 and allow to dry for 10 minutes. Fill cavity by tightly compressing Dry-Pac into the groove with pneumatic packing tool or with hammer and wood block.

Note:

- i. Areas of poor concrete consolidation that show evidence of leakage should also be repaired.
- ii. Against a direct flow of water (leakage) or where there is excess moisture due to seepage, use Xypex Patch’n Plug, then Xypex Dry-Pac followed by a brush coat of Xypex Concentrate.
- iii. For expansion joints or chronic moving cracks, flexible materials such as expansion joint sealants should be used.

3. WETTING CONCRETE Xypex requires a saturated surface dry (SSD) condition. Concrete surfaces must be thoroughly saturated with clean water prior to the application so as to aid the diffusion of the Xypex chemistry and to ensure growth of the crystalline formation deep within the pores of the concrete. Remove excess water before the application such that there is no glistening water on the surface. If concrete dries out before application, it must be re-wetted.

4. MIXING FOR SLURRY COAT Mix Xypex powder with clean water to a creamy consistency in the following proportions:

For Brush Application

1.25 - 1.5 lb./sq. yd. (0.65 - 0.8 kg/m²)
5 parts powder to 2 parts water

2.0 lb./sq. yd. (1.0 kg/m²)

3 parts powder to 1 part water

For Spray Application

1.25 - 1.5 lb./sq. yd. (0.65 - 0.8 kg/m²)
5 parts powder to 3 parts water
(ratio may vary with equipment type)

Do not mix more Xypex material than can be applied in 20 minutes. As the mixture thickens, stir briefly to ensure mixture remains fluid; but do not add water.

Mixing Dry-Pac

Using a trowel, mix 6 parts Xypex Concentrate powder by volume to 1 part clean water for 10 to 15 seconds. Lumps should be present in this mixture. Do not mix more than can be applied in 20 minutes.

5. APPLYING XYPEX Apply Xypex with a semi-stiff nylon bristle brush, push broom (for large horizontal surfaces) or specialized spray equipment. The coating must be uniformly applied and should be just under 1/16 in. (1.25 mm). When a second coat (Xypex Concentrate or Xypex Modified) is required, it should be applied after the first coat has reached an initial set but while it is still “green” (less than 48 hours). Curing by misting the coating with water should be done between coats. Ensure first coat is in SSD condition before application of the second coat. The Xypex treatment must not be applied under rainy conditions or when ambient temperature is below 40°F (4°C). Avoid application of the Xypex coating in hot and windy conditions as the coating may dry out prematurely. For recommended equipment, contact Xypex’s Technical Services Department or your local Xypex Technical Services Representative.

6. CURING Generally a misty fog spray of clean water is used for curing the Xypex treatment. Curing should begin as soon as the Xypex has set to the point where it will not be damaged by a fine spray of water. Under normal conditions, it is sufficient to spray Xypex-treated surfaces three times per day for two to three days. In hot or arid climates, spraying may be required more frequently. Wet burlap and some specialty curing blankets are also effective for curing. During the curing period, the coating must be protected from rainfall, frost, wind, the puddling of water and temperatures below 36°F (2°C) for a period of not less than 48 hours after application. If plastic sheeting is used as protection, it must be raised off the Xypex to allow the coating to breathe. Xypex Gamma Cure may be used in lieu of water curing for certain applications, consult with Xypex’s Technical Services Department or your local Xypex Technical Services Representative.

Note:

- i. For concrete structures that hold liquids (e.g. reservoirs, swimming pools, tanks, etc.), Xypex should be cured for three days and allowed to set for 12 days (18 days for waste water or corrosive solutions) before filling the structure with liquid.
- ii. For Xypex coated slabs that will be a wearing surface, an application of Xypex Quickset after the coating has been cured and dried is recommended. Contact your local Xypex Technical Services Representative for assistance.
- iii. If any other cementitious system is applied over the Xypex coating, it should be after the coating has completely set but while it is still green (12 to 48 hours); the 12 to 24 hour window is considered ideal. For installations onto a Xypex coating older than 48 hours contact your Xypex Technical Services Representative regarding surface preparation and application recommendations. Xypex Chemical Corporation makes no representations or warranties regarding the compatibility of Xypex prod-

ucts with plasters, stuccos, tiles and other surface-applied materials. Prior to the installation, it is recommended that a test section be completed under anticipated ambient and project conditions to demonstrate acceptable bond.

Technical Services

For more instructions, alternative installation methods, or information concerning the compatibility of the Xypex treatment with other products or technologies, contact the Technical Services Department of Xypex Chemical Corporation or your local Xypex Technical Services Representative.

Certification

Xypex Modified satisfies the requirements of EN 1504-3; Initial Type Testing (ITT) according to EN 1504-3 was certified by BSI as the Notifying Body.

Safe Handling Information

Xypex is alkaline. As a cementitious powder or mixture, Xypex may cause significant skin and eye irritation. Directions for treating these problems are clearly detailed on all Xypex pails and packaging. The Manufacturer also maintains comprehensive and up-to-date Safety Data Sheets on all its products. Each sheet contains health and safety information for the protection of workers and customers. The Manufacturer recommends you contact Xypex Chemical Corporation or your local Xypex Technical Services Representative to obtain copies of Safety Data Sheets prior to product storage or use.

Warranty

The Manufacturer warrants that the products manufactured by it shall be free from material defects and will be consistent with its normal high quality. Should any of the products be proven defective, the liability to the Manufacturer shall be limited to replacement of the product ex factory. The Manufacturer makes no warranty as to merchantability or fitness for a particular purpose and this warranty is in lieu of all other warranties expressed or implied. The user shall determine the suitability of the product for his intended use and assume all risks and liability in connection therewith.

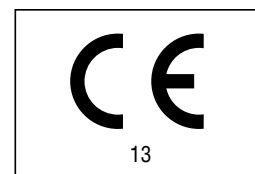

Description

Xypex is a unique chemical treatment for the waterproofing, protection and improvement of concrete. XYPEX ADMIX C-500/C-500 NF is added to the concrete mix at the time of batching. Xypex Admix C-500/C-500 NF consists of Portland cement, silica sand (excluding the NF grade) and various active, proprietary chemicals. These active chemicals react with the moisture in fresh concrete and with the by-products of cement hydration to cause a catalytic reaction. This reaction generates a non-soluble crystalline formation throughout the pores and capillary tracts of the concrete that permanently seals the concrete and prevents the penetration of water and other liquids from any direction.

Xypex Admix C-Series

All variations of the Admix C-Series contain the same amount of reactive chemicals at their prescribed dosage rates and provide the same waterproofing and durability performance characteristics. Xypex Admix C-Series is available in regular or no-fines grades (NF). **Xypex Admix C-500/C-500 NF** is formulated to have minimal or no effect on setting time. **Xypex Admix C-1000/C-1000 NF** is formulated for concrete mix designs where a normal or mildly delayed set is desired. **Xypex Admix C-2000/C-2000 NF** is designed for warmer climates and projects where a slower hydration rate is typically required. See Setting Time and Strength for more details. Consult with a Xypex Technical Services Representative for the most appropriate Xypex Admix for your project.

Recommended for:

- Reservoirs
- Sewage and Water Treatment Plants
- Secondary Containment Structures
- Tunnels and Subway Systems
- Underground Vaults
- Foundations / Basements
- Parking Structures
- Swimming Pools
- Precast Components
- Bridge Structures

Advantages

- Resists extreme hydrostatic pressure
- Becomes an integral part of the substrate
- Highly resistant to aggressive and chemical environments
- Can seal static hairline cracks up to 0.4 mm
- Allows concrete to breathe
- Non-toxic / no VOCs

- Less costly to install than most other methods
- Permanent
- Added to the concrete at time of batching and therefore is not subject to climatic restraints
- Increases flexibility in construction scheduling

Packaging

Xypex Admix C-500/C-500 NF is packaged in convenient sizes of various types of packaging, including paper bags and soluble bags. Contact your local Xypex Technical Services Representative or dealer for details and availability.

Storage

Xypex products must be stored dry at a minimum temperature of 45°F (7°C). Shelf life is one year when stored under proper conditions.

Dosage Rates

Xypex Admix C-500 (Regular Grade):

2 - 3% by weight of cement

Xypex Admix C-500 NF (No Fines Grade):

1 - 1.5% by weight of cement

Note:

1. For determining the appropriate dosage rate and for further information regarding concrete mixes containing fly ash / slag, enhanced chemical resistance, optimum concrete performance, or meeting the specific requirements and conditions of your project, consult with the local Xypex Technical Services Representative or Xypex's Technical Services Department.

2. Under certain conditions the dosage rate for the Admix NF (No Fines Grade) may be as low as 0.8% depending on the quantity and type of total cementitious materials.

Test Data

PERMEABILITY

U.S. Army Corps of Engineers CRD C48, "Permeability of Concrete", Aviles Engineering Corp., Houston, USA

Two concrete samples containing Xypex Admix and an untreated control sample were tested for water permeability. Both the treated and untreated samples were subjected to a pressure of 150 psi / 1.04 MPa (350 ft. / 106.7 m water head). Results showed moisture and permeated water throughout the untreated sample after 24 hours. However, the Xypex Admix samples showed no leakage, and water penetration of only 1.5 mm / 0.06 inches after 120 hours (5 days).

**U.S. Army Corps of Engineers CRD C48,
“Permeability of Concrete”, Setsco Services,
Pte Ltd., Singapore**

Six Xypex Admix-treated and six untreated concrete samples were tested for water permeability. Pressure was gradually increased over five days and then maintained at 7 bars (224 ft. / 68.3 m water head) for 10 days. While the six reference samples showed water leakage beginning on the fifth day and increasing throughout the test period, the Xypex Admix samples showed no water leakage at any time during the test.

ACCI Water Permeability Test, “Water Permeability of Concrete”, Australia Centre of Construction and Innovation, University of New South Wales, Sydney, Australia

Concrete samples containing Xypex Admix NF at a dosage rate of 0.8% and 1.2% were tested for water permeability against control samples. All the samples were subjected to a pressure of 10 bars (100 meters / 328 ft. water head) for 2 weeks. Water permeability coefficients were calculated and the Xypex Admix-treated concrete showed significant reduction in water permeability by up to 93% at a dosage rate of 1.2%.

STN EN 12390-8 “Testing of Hardened Concrete; Depth of Water Penetration Under Pressure”, Technical and Testing Construction Institute, Bratislava, Slovakia

Concrete cubes were prepared with Admix C-1000 at 2% and Admix C-1000 NF at 1% along with control cubes. A water pressure of 0.5 MPa was applied for 72 hrs and specimens were subsequently split transversely to measure depth of water penetration. Depth results for C-1000/C-1000 NF were 10.3 mm and 25 mm respectively, whereas penetration on control samples was 113 mm. In using the Valenta equation to calculate the water permeability coefficient, the C-1000/C-1000 NF treated concrete showed a 20 to 120x reduction compared to the control concrete.

COMPRESSIVE STRENGTH

ASTM C 39, “Compressive Strength of Cylindrical Concrete Specimens”, Kleinfelder Laboratories, San Francisco, USA

At 28 days, the compressive strength test of the concrete containing Xypex Admix measured 7160 psi / 49.5 MPa as compared to the reference sample at 6460 psi / 44.5 MPa (a 10% increase).

CHEMICAL RESISTANCE

CSN 73 1326 “Measuring Loss of Surface Due to Sulphate Attack of Concrete Treated with Admix C-1000/Admix C-1000 NF”, Betonconsult, Building Materials Testing Laboratory, Prague, Czech Republic
Concrete specimens treated with Admix C-1000 at 1% and 2%, and Admix C-1000 NF at 0.5% and 1% were cast along with non-treated concrete specimens. The speci-

mens were exposed to a highly concentrated sulphate solution (i.e. 36,000 mg/l) for 4 months and samples were periodically weighed to determine mass loss. The Admix treated samples recorded a mass loss between 5 and 50 g/m² and showed no surface deterioration, while the non-treated specimens measured an average mass loss of 4,860 g/m² with significant surface deterioration.

HB 84-2006 “Durability Assessment of Reinforced Concrete Structure Containing Xypex Admix Exposed to 19 Years of Severe Marine Environment”, Sharp and Howells Pty. Ltd., Chemical Laboratories, Victoria, Australia

Lascelles Wharf serves as a bulk chemical and grain dock. In 1995, as part of an extensive maintenance program and to protect new precast concrete panels from the extremely harsh and aggressive marine environment, the concrete was dosed with Xypex Admix C-2000 NF at 1%. Recently tests were conducted to predict “initiation time to corrosion”. Extracted cores were tested for chloride content at incremental depths into the concrete. Chloride content profiles, concrete cover, surface chloride content, and chloride corrosion threshold were used in a model based on Fick’s 2nd law to predict the residual service life of this structure. The average initiation time to corrosion was estimated at 164 years; whereas, the structure had been designed for 50 years of service life.

NT BUILD 443, “Chloride Diffusion by NordTest with 16.5% NaCl Solution of 40 MPa Concrete Containing Admix C-1000 NF”, Australia Centre for Construction Innovation, University of New South Wales, Sydney, Australia

The NordTest NT BUILD 443 is a standard accelerated method for evaluation of the chloride diffusion coefficient of concrete. In this test program, concrete mixes with 25% fly ash, 38% slag, and 60% slag were cast (total cementitious content = 435 kg, 0.4 w/c). Xypex Admix C-1000 NF at 0.8% and 1.2% by weight of cementitious materials were compared to control mixes (for each cement system). All specimens were immersed in a 16.5% NaCl solution for 35 days. Chloride diffusion coefficient was calculated based on the chloride profile, utilizing Fick’s 2nd law. Admix treated fly ash concrete showed 25% reduced chloride diffusion coefficient for both 0.8% and 1.2% addition. The Admix treated 38% slag concrete recorded a 67% lower chloride diffusion coefficient at 0.8% addition and 75% lower at 1.2% addition. The reduction of chloride diffusion coefficient was 42% and 53% for high slag mixes for 0.8% and 1.2% addition respectively.

“Sulfuric Acid Resistance Test”, Aviles Engineering Corporation, Houston, USA

Concrete containing Xypex Admix at different dosage rates including 3% specimens were tested against untreated control samples for sulfuric acid resistance. After immersion in the sulfuric acid, each sample was tested for weight loss on a daily basis until a weight loss of 50%

or a definite response trend was obtained. The percentage weight loss of the samples containing Xypex Admix tested significantly lower than the control samples.

“Acid Resistance of Mortar Containing Xypex Admix C-1000 NF”, Construction and Maintenance Technology Research Center (CONTEC), Sirindhorn International Institute of Technology (SIIT) - Thammasat University, Bangkok, Thailand

An acid testing regime was part of an extensive program to determine the benefit of the Xypex Admix C-1000 NF dosed at 1% to improve the durability of concrete. Several comparative mixes were utilized in this evaluation, including: a plain Portland cement and a 30% fly ash mix. Cured samples were exposed to 5% H₂SO₄; the pH value of this acid solution was 0.25 and never greater than 0.54 pH. In this extremely acidic, corrosive environment, at 12 weeks the Admix samples reduced the weight loss by 48% compared to controls of the cement-only mortar, and 53% in the fly ash specimens.

CRACK SEALING

ASTM C1585 and ASTM C1202 “Evaluation of Self-healing Capability of Self-compacting Concrete Made with Blast-furnace Slag Cements Activated by the Xypex Crystalline Catalyst”, Instituto Tecnológico de Aeronautica, Sao Jose dos Campos, Brazil

Portland, blast furnace slag and slag-modified Portland concrete samples, treated with 2.5% Admix C-500, were evaluated for self-healing capabilities. Microcracks were induced by loading to 90% of ultimate compressive strength. Cracked samples were then immersed in water to trigger self-healing after 28, 56 and 84 days. Strength and ultrasonic pulse velocity tests were used to determine mechanical recovery; sorptivity and rapid chloride permeability were used to evaluate watertightness recovery. Results substantiated the ability of Xypex Admix to provide self-healing of cracked concrete.

“Testing of Xypex Admix C-1000 NF Crack Healing Capabilities”, CH Karnchang (Lao) Company Ltd., Xayaburi Laboratory, Ban Xieng Yeun, Vientiane, Laos

Prior to construction of a Mekong River dam, testing was undertaken to substantiate the ability of Xypex Admix to self-heal static cracks up to 0.4 mm. Three large concrete slabs treated with Admix C-1000 NF at 0.8% were cast along with three control slabs. Following curing, a force was applied at the mid-point of each slab to create cracks; on average measuring 0.4 mm width. Water was ponded above the cracked area. Initially all cracks leaked; at 4 days all dripping had ceased from the cracks of the Xypex treated panels, while leaking continued through the cracks of the control slab until the end of the test period (25 days). SEM photographs showed significant crystalline growth throughout the cracks of the Admix treated slab.

SCANNING ELECTRON MICROSCOPY

SEM “Microscopic Examination of Crystalline Products in Three Xypex Admix Modified Concrete Mortars”, Australian Centre for Construction Innovation, University of New South Wales, Sydney, Australia

Slag and fly ash blended cement samples were treated with Xypex Admix and examined for evidence of crystalline growth at ages ranging from 8 months to 2 years. Samples were sliced and/or split and examined at magnifications between 500x and 5000x. Characteristic Xypex crystalline growth was observable on all Xypex treated samples, providing evidence of Xypex crystalline reactions with fly ash and slag blended cements.

FREEZE/THAW DURABILITY

ASTM C 666, “Freeze/Thaw Durability”, Independent Laboratory, Cleveland, USA

After 300 freeze/thaw cycles, the Xypex Admix-treated samples indicated 94% relative durability.

POTABLE WATER EXPOSURE

NSF 61, “Drinking Water System Component-Health Effects”, NSF International, Ann Arbor, USA

Exposure testing of potable water in contact with Xypex-treated samples indicated no harmful effects.

Directions for Use

Xypex Admix C-500/C-500 NF is added to the concrete at the time of batching. It is important to obtain a homogeneous mixture of Xypex Admix with the concrete. Do not add dry Admix powder directly to wet mixed concrete as this could cause clumping and thorough dispersion may not occur. The sequence of procedures for addition will vary according to the type of batch plant operation and equipment. The following methods have been used successfully in the past and it is recommended that the local Xypex Technical Services Representative be consulted about the best method to use.

1. ADDITION TO COARSE AGGREGATE BELT Add Admix powder directly to the coarse aggregate conveyor belt manually or through computer controlled mass batching system. Account for worker health and safety issues with moving belts and wind-blown dust issues.

2. TRUCK ADDITION (AT PLANT) Add Xypex Admix in bulk powder or soluble bag form to the drum of the ready-mix truck immediately prior to driving the truck under the batch plant and adding the balance of the materials or the premixed concrete in accordance with standard concrete batching practices. Measures to ensure soluble bags are dispersed include adding the bags as far forward in the drum as possible, adding a small amount of batch water with the bags, and spinning the drum prior to adding remaining ingredients. Avoid delays in adding other components and utilize high speed mixing to ensure homo-

geneity of mix. Where there may be insufficient water for thorough dispersion of the bulk powder, a water slurry can be made with the Admix and added to the truck mixer drum prior to batching. Account for added water in the mix design and slump.

3. ADDITION TO CENTRAL MIXER Load the Admix in bulk powder form or in soluble bags along with the other components. Mix as per standard batching practices to ensure thorough dispersal of the Admix resulting in a homogeneous mixture. Account for worker safety issues when accessing the equipment.

Note:

- i. Although addition on site in powder form is not normally recommended, it may be necessary. In such a case, add Xypex Admix to truck in slurry form (e.g. 3 parts powder to 2 parts water by volume). Mix concrete for a minimum of 5 minutes on high speed or until thoroughly dispersed. Account for added water in the mix design and slump.
- ii. Concrete containing the Xypex Admix does not preclude the requirement for design of crack control, construction joint detailing, proper placement, consolidation and curing of the concrete and measures for repairing defects such as honeycombing, tie holes, cracks beyond specified limits.
- iii. Further guidelines are available that address the use of Xypex Admix for a specific situation, (e.g. dry mixes, use of ice in hot ambient conditions, cold-weather concreting, etc.). Consult with a local Xypex Technical Services Representative or Xypex's Technical Services Department for further information.

Setting Time and Strength

The setting time of concrete is affected by the chemical and physical composition of ingredients, temperature of the concrete and climatic conditions. Xypex Admix C-500/C-500 NF is designed to have minimal or no effect on setting time. Concrete containing the Xypex Admix C-500/C-500 NF may develop higher ultimate strengths than plain concrete. Trial mixes should be carried out under project conditions to determine the setting time and strength of the concrete dosed with Xypex Admix C-500/C-500 NF. Consult with a Xypex Technical Services Representative for the most appropriate Xypex Admix for your project.

Limitations

When incorporating Xypex Admix, the temperature of the concrete mix should be above 40°F (4°C).

Technical Services

For more instructions, alternative installation methods, or information concerning the compatibility of the Xypex treatment with other products or technologies, contact the Technical Services Department of Xypex Chemical Corporation or your local Xypex Technical Services Representative.

Certification

Xypex Admix satisfies the requirements of EN-934-2; Initial Type Testing (ITT) according to EN-934-2 was certified by BSI as the Notifying Body.

Safe Handling Information

Xypex is alkaline. As a cementitious powder or mixture, Xypex may cause significant skin and eye irritation. Directions for treating these problems are clearly detailed on all Xypex pails and packaging. The Manufacturer also maintains comprehensive and up-to-date Safety Data Sheets on all its products. Each sheet contains health and safety information for the protection of workers and customers. The Manufacturer recommends you contact Xypex Chemical Corporation or your local Xypex Technical Services Representative to obtain copies of Safety Data Sheets prior to product storage or use.

Warranty

The Manufacturer warrants that the products manufactured by it shall be free from material defects and will be consistent with its normal high quality. Should any of the products be proven defective, the liability to the Manufacturer shall be limited to replacement of the product ex factory. The Manufacturer makes no warranty as to merchantability or fitness for a particular purpose and this warranty is in lieu of all other warranties expressed or implied. The user shall determine the suitability of the product for his intended use and assume all risks and liability in connection therewith.

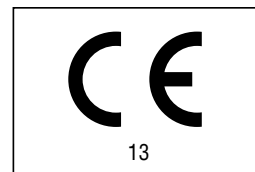

Description

Xypex is a unique chemical treatment for the waterproofing, protection and improvement of concrete. XYPEX ADMIX C-1000/C-1000 NF is added to the concrete mix at the time of batching. Xypex Admix C-1000/C-1000 NF consists of Portland cement, silica sand (excluding the NF grade) and various active, proprietary chemicals. These active chemicals react with the moisture in fresh concrete and with the by-products of cement hydration to cause a catalytic reaction. This reaction generates a non-soluble crystalline formation throughout the pores and capillary tracts of the concrete that permanently seals the concrete and prevents the penetration of water and other liquids from any direction.

Xypex Admix C-Series

All variations of the Admix C-Series contain the same amount of reactive chemicals at their prescribed dosage rates and provide the same waterproofing and durability performance characteristics. Xypex Admix C-Series is available in regular or no-fines grades (NF). **Xypex Admix C-500/C-500 NF** is formulated to have minimal or no effect on setting time. **Xypex Admix C-1000/C-1000 NF** is formulated for concrete mix designs where a normal or mildly delayed set is desired. **Xypex Admix C-2000/C-2000 NF** is designed for warmer climates and projects where a slower hydration rate is typically required. See Setting Time and Strength for more details. Consult with a Xypex Technical Services Representative for the most appropriate Xypex Admix for your project.

Recommended for:

- Reservoirs
- Sewage and Water Treatment Plants
- Secondary Containment Structures
- Tunnels and Subway Systems
- Underground Vaults
- Foundations / Basements
- Parking Structures
- Swimming Pools
- Precast Components
- Bridge Structures

Advantages

- Resists extreme hydrostatic pressure
- Becomes an integral part of the substrate
- Highly resistant to aggressive and chemical environments
- Can seal static hairline cracks up to 0.4 mm
- Allows concrete to breathe
- Non-toxic / no VOCs

- Less costly to install than most other methods
- Permanent
- Added to the concrete at time of batching and therefore is not subject to climatic restraints
- Increases flexibility in construction scheduling

Packaging

Xypex Admix C-1000/C-1000 NF is packaged in convenient sizes of various types of packaging, including pails, paper bags and soluble bags. Contact your local Xypex Technical Services Representative or dealer for details and availability.

Storage

Xypex products must be stored dry at a minimum temperature of 45°F (7°C). Shelf life is one year when stored under proper conditions.

Dosage Rates

Xypex Admix C-1000 (Regular Grade):

2 - 3% by weight of cement

Xypex Admix C-1000 NF (No Fines Grade):

1 - 1.5% by weight of cement

Note:

1. For determining the appropriate dosage rate and for further information regarding concrete mixes containing fly ash / slag, enhanced chemical resistance, optimum concrete performance, or meeting the specific requirements and conditions of your project, consult with the local Xypex Technical Services Representative or Xypex's Technical Services Department.

2. Under certain conditions the dosage rate for the Admix NF (No Fines Grade) may be as low as 0.8% depending on the quantity and type of total cementitious materials.

Test Data

PERMEABILITY

U.S. Army Corps of Engineers CRD C48, "Permeability of Concrete", Aviles Engineering Corp., Houston, USA

Two concrete samples containing Xypex Admix and an untreated control sample were tested for water permeability. Both the treated and untreated samples were subjected to a pressure of 150 psi / 1.04 MPa (350 ft. / 106.7 m water head). Results showed moisture and permeated water throughout the untreated sample after 24 hours. However, the Xypex Admix samples showed no leakage, and water penetration of only 1.5 mm / 0.06 inches after 120 hours (5 days).

**U.S. Army Corps of Engineers CRD C48,
“Permeability of Concrete”, Setsco Services,
Pte Ltd., Singapore**

Six Xypex Admix-treated and six untreated concrete samples were tested for water permeability. Pressure was gradually increased over five days and then maintained at 7 bars (224 ft. / 68.3 m water head) for 10 days. While the six reference samples showed water leakage beginning on the fifth day and increasing throughout the test period, the Xypex Admix samples showed no water leakage at any time during the test.

ACCI Water Permeability Test, “Water Permeability of Concrete”, Australia Centre of Construction and Innovation, University of New South Wales, Sydney, Australia

Concrete samples containing Xypex Admix NF at a dosage rate of 0.8% and 1.2% were tested for water permeability against control samples. All the samples were subjected to a pressure of 10 bars (100 meters / 328 ft. water head) for 2 weeks. Water permeability coefficients were calculated and the Xypex Admix-treated concrete showed significant reduction in water permeability by up to 93% at a dosage rate of 1.2%.

STN EN 12390-8 “Testing of Hardened Concrete; Depth of Water Penetration Under Pressure”, Technical and Testing Construction Institute, Bratislava, Slovakia

Concrete cubes were prepared with Admix C-1000 at 2% and Admix C-1000 NF at 1% along with control cubes. A water pressure of 0.5 MPa was applied for 72 hrs and specimens were subsequently split transversely to measure depth of water penetration. Depth results for C-1000/C-1000 NF were 10.3 mm and 25 mm respectively, whereas penetration on control samples was 113 mm. In using the Valenta equation to calculate the water permeability coefficient, the C-1000/C-1000 NF treated concrete showed a 20 to 120x reduction compared to the control concrete.

COMPRESSIVE STRENGTH

ASTM C 39, “Compressive Strength of Cylindrical Concrete Specimens”, Kleinfelder Laboratories, San Francisco, USA

At 28 days, the compressive strength test of the concrete containing Xypex Admix measured 7160 psi / 49.5 MPa as compared to the reference sample at 6460 psi / 44.5 MPa (a 10% increase).

CHEMICAL RESISTANCE

CSN 73 1326 “Measuring Loss of Surface Due to Sulphate Attack of Concrete Treated with Admix C-1000/Admix C-1000 NF”, Betonconsult, Building Materials Testing Laboratory, Prague, Czech Republic
Concrete specimens treated with Admix C-1000 at 1% and 2%, and Admix C-1000 NF at 0.5% and 1% were cast along with non-treated concrete specimens. The speci-

mens were exposed to a highly concentrated sulphate solution (i.e. 36,000 mg/l) for 4 months and samples were periodically weighed to determine mass loss. The Admix treated samples recorded a mass loss between 5 and 50 g/m² and showed no surface deterioration, while the non-treated specimens measured an average mass loss of 4,860 g/m² with significant surface deterioration.

HB 84-2006 “Durability Assessment of Reinforced Concrete Structure Containing Xypex Admix Exposed to 19 Years of Severe Marine Environment”, Sharp and Howells Pty. Ltd., Chemical Laboratories, Victoria, Australia

Lascelles Wharf serves as a bulk chemical and grain dock. In 1995, as part of an extensive maintenance program and to protect new precast concrete panels from the extremely harsh and aggressive marine environment, the concrete was dosed with Xypex Admix C-2000 NF at 1%. Recently tests were conducted to predict “initiation time to corrosion”. Extracted cores were tested for chloride content at incremental depths into the concrete. Chloride content profiles, concrete cover, surface chloride content, and chloride corrosion threshold were used in a model based on Fick’s 2nd law to predict the residual service life of this structure. The average initiation time to corrosion was estimated at 164 years; whereas, the structure had been designed for 50 years of service life.

NT BUILD 443, “Chloride Diffusion by NordTest with 16.5% NaCl Solution of 40 MPa Concrete Containing Admix C-1000 NF”, Australia Centre for Construction Innovation, University of New South Wales, Sydney, Australia

The NordTest NT BUILD 443 is a standard accelerated method for evaluation of the chloride diffusion coefficient of concrete. In this test program, concrete mixes with 25% fly ash, 38% slag, and 60% slag were cast (total cementitious content = 435 kg, 0.4 w/c). Xypex Admix C-1000 NF at 0.8% and 1.2% by weight of cementitious materials were compared to control mixes (for each cement system). All specimens were immersed in a 16.5% NaCl solution for 35 days. Chloride diffusion coefficient was calculated based on the chloride profile, utilizing Fick’s 2nd law. Admix treated fly ash concrete showed 25% reduced chloride diffusion coefficient for both 0.8% and 1.2% addition. The Admix treated 38% slag concrete recorded a 67% lower chloride diffusion coefficient at 0.8% addition and 75% lower at 1.2% addition. The reduction of chloride diffusion coefficient was 42% and 53% for high slag mixes for 0.8% and 1.2% addition respectively.

“Sulfuric Acid Resistance Test”, Aviles Engineering Corporation, Houston, USA

Concrete containing Xypex Admix at different dosage rates including 3% specimens were tested against untreated control samples for sulfuric acid resistance. After immersion in the sulfuric acid, each sample was tested for weight loss on a daily basis until a weight loss of 50%

or a definite response trend was obtained. The percentage weight loss of the samples containing Xypex Admix tested significantly lower than the control samples.

“Acid Resistance of Mortar Containing Xypex Admix C-1000 NF”, Construction and Maintenance Technology Research Center (CONTEC), Sirindhorn International Institute of Technology (SIIT) - Thammasat University, Bangkok, Thailand

An acid testing regime was part of an extensive program to determine the benefit of the Xypex Admix C-1000 NF dosed at 1% to improve the durability of concrete. Several comparative mixes were utilized in this evaluation, including: a plain Portland cement and a 30% fly ash mix. Cured samples were exposed to 5% H₂SO₄; the pH value of this acid solution was 0.25 and never greater than 0.54 pH. In this extremely acidic, corrosive environment, at 12 weeks the Admix samples reduced the weight loss by 48% compared to controls of the cement-only mortar, and 53% in the fly ash specimens.

CRACK SEALING

ASTM C1585 and ASTM C1202 “Evaluation of Self-healing Capability of Self-compacting Concrete Made with Blast-furnace Slag Cements Activated by the Xypex Crystalline Catalyst”, Instituto Tecnológico de Aeronautica, Sao Jose dos Campos, Brazil

Portland, blast furnace slag and slag-modified Portland concrete samples, treated with 2.5% Admix C-500, were evaluated for self-healing capabilities. Microcracks were induced by loading to 90% of ultimate compressive strength. Cracked samples were then immersed in water to trigger self-healing after 28, 56 and 84 days. Strength and ultrasonic pulse velocity tests were used to determine mechanical recovery; sorptivity and rapid chloride permeability were used to evaluate watertightness recovery. Results substantiated the ability of Xypex Admix to provide self-healing of cracked concrete.

“Testing of Xypex Admix C-1000 NF Crack Healing Capabilities”, CH Karnchang (Lao) Company Ltd., Xayaburi Laboratory, Ban Xieng Yeun, Vientiane, Laos

Prior to construction of a Mekong River dam, testing was undertaken to substantiate the ability of Xypex Admix to self-heal static cracks up to 0.4 mm. Three large concrete slabs treated with Admix C-1000 NF at 0.8% were cast along with three control slabs. Following curing, a force was applied at the mid-point of each slab to create cracks; on average measuring 0.4 mm width. Water was ponded above the cracked area. Initially all cracks leaked; at 4 days all dripping had ceased from the cracks of the Xypex treated panels, while leaking continued through the cracks of the control slab until the end of the test period (25 days). SEM photographs showed significant crystalline growth throughout the cracks of the Admix treated slab.

SCANNING ELECTRON MICROSCOPY

SEM “Microscopic Examination of Crystalline Products in Three Xypex Admix Modified Concrete Mortars”, Australian Centre for Construction Innovation, University of New South Wales, Sydney, Australia

Slag and fly ash blended cement samples were treated with Xypex Admix and examined for evidence of crystalline growth at ages ranging from 8 months to 2 years. Samples were sliced and/or split and examined at magnifications between 500x and 5000x. Characteristic Xypex crystalline growth was observable on all Xypex treated samples, providing evidence of Xypex crystalline reactions with fly ash and slag blended cements.

FREEZE/THAW DURABILITY

ASTM C 666, “Freeze/Thaw Durability”, Independent Laboratory, Cleveland, USA

After 300 freeze/thaw cycles, the Xypex Admix-treated samples indicated 94% relative durability.

POTABLE WATER EXPOSURE

NSF 61, “Drinking Water System Component-Health Effects”, NSF International, Ann Arbor, USA

Exposure testing of potable water in contact with Xypex-treated samples indicated no harmful effects.

Directions for Use

Xypex Admix C-1000/C-1000 NF is added to the concrete at the time of batching. It is important to obtain a homogeneous mixture of Xypex Admix with the concrete. Do not add dry Admix powder directly to wet mixed concrete as this could cause clumping and thorough dispersion may not occur. The sequence of procedures for addition will vary according to the type of batch plant operation and equipment. The following methods have been used successfully in the past and it is recommended that the local Xypex Technical Services Representative be consulted about the best method to use.

1. ADDITION TO COARSE AGGREGATE BELT Add Xypex Admix powder directly to the coarse aggregate conveyor belt manually or through computer controlled mass batching system. Account for worker health and safety issues with moving belts and wind-blown dust issues.

2. TRUCK ADDITION (AT PLANT) Add Xypex Admix in bulk powder or soluble bag form to the drum of the ready-mix truck immediately prior to driving the truck under the batch plant and adding the balance of the materials or the premixed concrete in accordance with standard concrete batching practices. Measures to ensure soluble bags are dispersed include adding the bags as far forward in the drum as possible, adding a small amount of batch water with the bags, and spinning the drum prior to adding remaining ingredients. Avoid delays in adding other components and utilize high speed mixing to ensure homo-

geneity of mix. Where there may be insufficient water for thorough dispersion of the bulk powder, a water slurry can be made with the Admix and added to the truck mixer drum prior to batching. Account for added water in the mix design and slump.

3. ADDITION TO CENTRAL MIXER Load the Admix in bulk powder form or in soluble bags along with the other components. Mix as per standard batching practices to ensure thorough dispersal of the Admix resulting in a homogeneous mixture. Account for worker safety issues when accessing the equipment.

Note:

- i. Although addition on site in powder form is not normally recommended, it may be necessary. In such a case, add Xypex Admix to truck in slurry form (e.g. 3 parts powder to 2 parts water by volume). Mix concrete for a minimum of 5 minutes on high speed or until thoroughly dispersed. Account for added water in the mix design and slump.
- ii. Concrete containing the Xypex Admix does not preclude the requirement for design of crack control, construction joint detailing, proper placement, consolidation and curing of the concrete and measures for repairing defects such as honeycombing, tie holes, cracks beyond specified limits.
- iii. Further guidelines are available that address the use of Xypex Admix for a specific situation, (e.g. dry mixes, use of ice in hot ambient conditions, cold-weather concreting, etc.). Consult with a local Xypex Technical Services Representative or Xypex's Technical Services Department for further information.

Setting Time and Strength

The setting time of concrete is affected by the chemical and physical composition of ingredients, temperature of the concrete and climatic conditions. Xypex Admix C-1000/C-1000 NF is designed for concrete mix designs where a normal or mildly delayed set is desired. Concrete containing the Admix C-1000/C-1000 NF may develop higher ultimate strengths than plain concrete. Trial mixes should be carried out under project conditions to determine the setting time and strength of the concrete dosed with Admix C-1000/C-1000 NF. Consult with a Xypex Technical Services Representative for the most appropriate Xypex Admix for your project.

Limitations

When incorporating Xypex Admix, the temperature of the concrete mix should be above 40°F (4°C).

Technical Services

For more instructions, alternative installation methods, or information concerning the compatibility of the Xypex treatment with other products or technologies, contact the Technical Services Department of Xypex Chemical Corporation or your local Xypex Technical Services Representative.

Certification

Xypex Admix satisfies the requirements of EN-934-2; Initial Type Testing (ITT) according to EN-934-2 was certified by BSI as the Notifying Body.

Safe Handling Information

Xypex is alkaline. As a cementitious powder or mixture, Xypex may cause significant skin and eye irritation. Directions for treating these problems are clearly detailed on all Xypex pails and packaging. The Manufacturer also maintains comprehensive and up-to-date Safety Data Sheets on all its products. Each sheet contains health and safety information for the protection of workers and customers. The Manufacturer recommends you contact Xypex Chemical Corporation or your local Xypex Technical Services Representative to obtain copies of Safety Data Sheets prior to product storage or use.

Warranty

The Manufacturer warrants that the products manufactured by it shall be free from material defects and will be consistent with its normal high quality. Should any of the products be proven defective, the liability to the Manufacturer shall be limited to replacement of the product ex factory. The Manufacturer makes no warranty as to merchantability or fitness for a particular purpose and this warranty is in lieu of all other warranties expressed or implied. The user shall determine the suitability of the product for his intended use and assume all risks and liability in connection therewith.

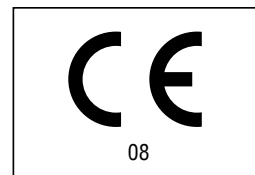

Description

Xypex is a unique chemical treatment for the waterproofing, protection and improvement of concrete. XYPEX ADMIX C-2000/C-2000 NF is added to the concrete mix at the time of batching. Xypex Admix C-2000/C-2000 NF consists of Portland cement and various active, proprietary chemicals. These active chemicals react with the moisture in fresh concrete and with the by-products of cement hydration to cause a catalytic reaction. This reaction generates a non-soluble crystalline formation throughout the pores and capillary tracts of the concrete that permanently seals the concrete and prevents the penetration of water and other liquids from any direction.

Xypex Admix C-Series

All variations of the Admix C-Series contain the same amount of reactive chemicals at their prescribed dosage rates and provide the same waterproofing and durability performance characteristics. Xypex Admix C-Series is available in regular or no-fines grades (NF). **Xypex Admix C-500/C-500 NF** is formulated to have minimal or no effect on setting time. **Xypex Admix C-1000/C-1000 NF** is formulated for concrete mix designs where a normal or mildly delayed set is desired. **Xypex Admix C-2000/ C-2000 NF** is designed for warmer climates and projects where a slower hydration rate is typically required. See Setting Time and Strength for more details. Consult with a Xypex Technical Services Representative for the most appropriate Xypex Admix for your project.

Recommended for:

- Reservoirs
- Sewage and Water Treatment Plants
- Secondary Containment Structures
- Tunnels and Subway Systems
- Underground Vaults
- Foundations / Basements
- Parking Structures
- Swimming Pools
- Precast Components
- Bridge Structures

Advantages

- Resists extreme hydrostatic pressure
- Becomes an integral part of the substrate
- Highly resistant to aggressive and chemical environments
- Can seal static hairline cracks up to 0.4 mm
- Allows concrete to breathe
- Non-toxic / no VOCs

- Less costly to install than most other methods
- Permanent
- Added into the concrete at time of batching and therefore is not subject to climatic restraints
- Increases flexibility in construction scheduling

Packaging

Xypex Admix C-2000/C-2000 NF is available in a variety of conveniently sized packaging. Contact your local Xypex Technical Services Representative or dealer for details and availability.

Storage

Xypex products must be stored dry at a minimum temperature of 45°F (7°C). Shelf life is one year when stored under proper conditions.

Dosage Rates

Xypex Admix C-2000 (Regular Grade):

2% by weight of cement

Xypex Admix C-2000 NF (No Fines Grade):

1% by weight of cement

Note:

1. For determining the appropriate dosage rate and for further information regarding concrete mixes containing fly ash / slag, enhanced chemical resistance, optimum concrete performance, or meeting the specific requirements and conditions of your project, consult with the local Xypex Technical Services Representative or Xypex's Technical Services Department.

2. Under certain conditions the dosage rate for the Admix NF (No Fines Grade) may be as low as 0.8% depending on the quantity and type of total cementitious materials.

Test Data

PERMEABILITY

U.S. Army Corps of Engineers CRD C48, "Permeability of Concrete", Aviles Engineering Corp., Houston, USA

Two concrete samples containing Xypex Admix and an untreated control sample were tested for water permeability. Both the treated and untreated samples were subjected to a pressure of 150 psi / 1.04 MPa (350 ft. / 106.7 m water head). Results showed moisture and permeated water throughout the untreated sample after 24 hours. However, the Xypex Admix samples showed no leakage, and water penetration of only 1.5 mm / 0.06 inches after 120 hours (5 days).

**U.S. Army Corps of Engineers CRD C48,
“Permeability of Concrete”, Setsco Services,
Pte Ltd., Singapore**

Six Xypex Admix-treated and six untreated concrete samples were tested for water permeability. Pressure was gradually increased over five days and then maintained at 7 bars (224 ft. / 68.3 m water head) for 10 days. While the six reference samples showed water leakage beginning on the fifth day and increasing throughout the test period, the Xypex Admix samples showed no water leakage at any time during the test.

ACCI Water Permeability Test, “Water Permeability of Concrete”, Australia Centre of Construction and Innovation, University of New South Wales, Sydney, Australia

Concrete samples containing Xypex Admix NF at a dosage rate of 0.8% and 1.2% were tested for water permeability against control samples. All the samples were subjected to a pressure of 10 bars (100 meters / 328 ft. water head) for 2 weeks. Water permeability coefficients were calculated and the Xypex Admix-treated concrete showed significant reduction in water permeability by up to 93% at a dosage rate of 1.2%.

STN EN 12390-8 “Testing of Hardened Concrete; Depth of Water Penetration Under Pressure”, Technical and Testing Construction Institute, Bratislava, Slovakia

Concrete cubes were prepared with Admix C-1000 at 2% and Admix C-1000 NF at 1% along with control cubes. A water pressure of 0.5 MPa was applied for 72 hrs and specimens were subsequently split transversely to measure depth of water penetration. Depth results for C-1000/C-1000 NF were 10.3 mm and 25 mm respectively, whereas penetration on control samples was 113 mm. In using the Valenta equation to calculate the water permeability coefficient, the C-1000/C-1000 NF treated concrete showed a 20 to 120x reduction compared to the control concrete.

COMPRESSIVE STRENGTH

ASTM C 39, “Compressive Strength of Cylindrical Concrete Specimens”, Kleinfelder Laboratories, San Francisco, USA

At 28 days, the compressive strength test of the concrete containing Xypex Admix measured 7160 psi / 49.5 MPa as compared to the reference sample at 6460 psi / 44.5 MPa (a 10% increase).

CHEMICAL RESISTANCE

CSN 73 1326 “Measuring Loss of Surface Due to Sulphate Attack of Concrete Treated with Admix C-1000/Admix C-1000 NF”, Betonconsult, Building Materials Testing Laboratory, Prague, Czech Republic
Concrete specimens treated with Admix C-1000 at 1% and 2%, and Admix C-1000 NF at 0.5% and 1% were cast along with non-treated concrete specimens. The speci-

mens were exposed to a highly concentrated sulphate solution (i.e. 36,000 mg/l) for 4 months and samples were periodically weighed to determine mass loss. The Admix treated samples recorded a mass loss between 5 and 50 g/m² and showed no surface deterioration, while the non-treated specimens measured an average mass loss of 4,860 g/m² with significant surface deterioration.

HB 84-2006 “Durability Assessment of Reinforced Concrete Structure Containing Xypex Admix Exposed to 19 Years of Severe Marine Environment”, Sharp and Howells Pty. Ltd., Chemical Laboratories, Victoria, Australia

Lascelles Wharf serves as a bulk chemical and grain dock. In 1995, as part of an extensive maintenance program and to protect new precast concrete panels from the extremely harsh and aggressive marine environment, the concrete was dosed with Xypex Admix C-2000 NF at 1%. Recently tests were conducted to predict “initiation time to corrosion”. Extracted cores were tested for chloride content at incremental depths into the concrete. Chloride content profiles, concrete cover, surface chloride content, and chloride corrosion threshold were used in a model based on Fick’s 2nd law to predict the residual service life of this structure. The average initiation time to corrosion was estimated at 164 years; whereas, the structure had been designed for 50 years of service life.

NT BUILD 443, “Chloride Diffusion by NordTest with 16.5% NaCl Solution of 40 MPa Concrete Containing Admix C-1000 NF”, Australia Centre for Construction Innovation, University of New South Wales, Sydney, Australia

The NordTest NT BUILD 443 is a standard accelerated method for evaluation of the chloride diffusion coefficient of concrete. In this test program, concrete mixes with 25% fly ash, 38% slag, and 60% slag were cast (total cementitious content = 435 kg, 0.4 w/c). Xypex Admix C-1000 NF at 0.8% and 1.2% by weight of cementitious materials were compared to control mixes (for each cement system). All specimens were immersed in a 16.5% NaCl solution for 35 days. Chloride diffusion coefficient was calculated based on the chloride profile, utilizing Fick’s 2nd law. Admix treated fly ash concrete showed 25% reduced chloride diffusion coefficient for both 0.8% and 1.2% addition. The Admix treated 38% slag concrete recorded a 67% lower chloride diffusion coefficient at 0.8% addition and 75% lower at 1.2% addition. The reduction of chloride diffusion coefficient was 42% and 53% for high slag mixes for 0.8% and 1.2% addition respectively.

“Sulfuric Acid Resistance Test”, Aviles Engineering Corporation, Houston, USA

Concrete containing Xypex Admix at different dosage rates including 3% specimens were tested against untreated control samples for sulfuric acid resistance. After immersion in the sulfuric acid, each sample was tested for weight loss on a daily basis until a weight loss of 50%

or a definite response trend was obtained. The percentage weight loss of the samples containing Xypex Admix tested significantly lower than the control samples.

“Acid Resistance of Mortar Containing Xypex Admix C-1000 NF”, Construction and Maintenance Technology Research Center (CONTEC), Sirindhorn International Institute of Technology (SIIT) - Thammasat University, Bangkok, Thailand

An acid testing regime was part of an extensive program to determine the benefit of the Xypex Admix C-1000 NF dosed at 1% to improve the durability of concrete. Several comparative mixes were utilized in this evaluation, including: a plain Portland cement and a 30% fly ash mix. Cured samples were exposed to 5% H₂SO₄; the pH value of this acid solution was 0.25 and never greater than 0.54 pH. In this extremely acidic, corrosive environment, at 12 weeks the Admix samples reduced the weight loss by 48% compared to controls of the cement-only mortar, and 53% in the fly ash specimens.

CRACK SEALING

ASTM C1585 and ASTM C1202 “Evaluation of Self-healing Capability of Self-compacting Concrete Made with Blast-furnace Slag Cements Activated by the Xypex Crystalline Catalyst”, Instituto Tecnológico de Aeronautica, Sao Jose dos Campos, Brazil

Portland, blast furnace slag and slag-modified Portland concrete samples, treated with 2.5% Admix C-500, were evaluated for self-healing capabilities. Microcracks were induced by loading to 90% of ultimate compressive strength. Cracked samples were then immersed in water to trigger self-healing after 28, 56 and 84 days. Strength and ultrasonic pulse velocity tests were used to determine mechanical recovery; sorptivity and rapid chloride permeability were used to evaluate watertightness recovery. Results substantiated the ability of Xypex Admix to provide self-healing of cracked concrete.

“Testing of Xypex Admix C-1000 NF Crack Healing Capabilities”, CH Karnchang (Lao) Company Ltd., Xayaburi Laboratory, Ban Xieng Yeun, Vientiane, Laos

Prior to construction of a Mekong River dam, testing was undertaken to substantiate the ability of Xypex Admix to self-heal static cracks up to 0.4 mm. Three large concrete slabs treated with Admix C-1000 NF at 0.8% were cast along with three control slabs. Following curing, a force was applied at the mid-point of each slab to create cracks; on average measuring 0.4 mm width. Water was ponded above the cracked area. Initially all cracks leaked; at 4 days all dripping had ceased from the cracks of the Xypex treated panels, while leaking continued through the cracks of the control slab until the end of the test period (25 days). SEM photographs showed significant crystalline growth throughout the cracks of the Admix treated slab.

SCANNING ELECTRON MICROSCOPY

SEM “Microscopic Examination of Crystalline Products in Three Xypex Admix Modified Concrete Mortars”, Australian Centre for Construction Innovation, University of New South Wales, Sydney, Australia

Slag and fly ash blended cement samples were treated with Xypex Admix and examined for evidence of crystalline growth at ages ranging from 8 months to 2 years. Samples were sliced and/or split and examined at magnifications between 500x and 5000x. Characteristic Xypex crystalline growth was observable on all Xypex treated samples, providing evidence of Xypex crystalline reactions with fly ash and slag blended cements.

FREEZE/THAW DURABILITY

ASTM C 666, “Freeze/Thaw Durability”, Independent Laboratory, Cleveland, USA

After 300 freeze/thaw cycles, the Xypex Admix-treated samples indicated 94% relative durability.

POTABLE WATER EXPOSURE

NSF 61, “Drinking Water System Component-Health Effects”, NSF International, Ann Arbor, USA

Exposure testing of potable water in contact with Xypex-treated samples indicated no harmful effects.

Directions for Use

Xypex Admix C-2000/C-2000 NF is added to the concrete at the time of batching. It is important to obtain a homogeneous mixture of Xypex Admix with the concrete. Do not add dry Admix powder directly to wet mixed concrete as this could cause clumping and thorough dispersion may not occur. The sequence of procedures for addition will vary according to the type of batch plant operation and equipment. The following methods have been used successfully in the past and it is recommended that the local Xypex Technical Services Representative be consulted about the best method to use.

1. ADDITION TO COARSE AGGREGATE BELT Add Xypex Admix powder directly to the coarse aggregate conveyor belt manually or through computer controlled mass batching system. Account for worker health and safety issues with moving belts and wind-blown dust issues.

2. TRUCK ADDITION (AT PLANT) Add Xypex Admix in bulk powder form to the drum of the ready-mix truck immediately prior to driving the truck under the batch plant and adding the balance of the materials or the pre-mixed concrete in accordance with standard concrete batching practices. Avoid delays in adding other components and utilize high speed mixing to ensure homogeneity of mix. Where there may be insufficient water for thorough dispersion of the bulk powder, a water slurry can be made with the Admix and added to the truck mixer drum prior to batching. Account for added water in the mix design and slump.

3. ADDITION TO CENTRAL MIXER Load the Admix in bulk powder form along with the other components. Mix as per standard batching practices to ensure thorough dispersal of the Admix resulting in a homogeneous mixture. Account for worker safety issues when accessing the equipment.

Note:

- i. Although addition on site in powder form is not normally recommended, it may be necessary. In such a case, add Xypex Admix to truck in slurry form (e.g. 3 parts powder to 2 parts water by volume). Mix concrete for a minimum of 5 minutes on high speed or until thoroughly dispersed. Account for added water in the mix design and slump.
- ii. Concrete containing the Xypex Admix does not preclude the requirement for design of crack control, construction joint detailing, proper placement, consolidation and curing of the concrete and measures for repairing defects such as honeycombing, tie holes, cracks beyond specified limits.
- iii. Further guidelines are available that address the use of Xypex Admix for a specific situation, (e.g. dry mixes, use of ice in hot ambient conditions, cold-weather concreting, etc.). Consult with a local Xypex Technical Services Representative or Xypex's Technical Services Department for further information.

Setting Time and Strength

The setting time and strength is affected by the chemical and physical composition of ingredients, temperature of the concrete and climatic conditions. Admix C-2000/C-2000 NF is designed for warmer climates and projects where a slower hydration rate is typically required. Concrete containing Xypex Admix C-2000/C-2000 NF may develop higher ultimate strengths than untreated concrete. Admix C-2000 NF may also be beneficial in controlling peak temperatures in mass concrete pours. Trial mixes should be carried out under project conditions to determine the setting time and strength of the concrete dosed with Xypex Admix C-2000/C-2000 NF. Consult with a Xypex Technical Services Representative for the most appropriate Xypex Admix for your project.

Limitations

When incorporating Xypex Admix, the temperature of the concrete mix should be above 40°F (4°C).

Technical Services

For more instructions, alternative installation methods, or information concerning the compatibility of the Xypex treatment with other products or technologies, contact the Technical Services Department of Xypex Chemical Corporation or your local Xypex Technical Services Representative.

Certification

Xypex Admix satisfies the requirements of EN-934-2; Initial Type Testing (ITT) according to EN-934-2 was certified by BSI as the Notifying Body.

Safe Handling Information

Xypex is alkaline. As a cementitious powder or mixture, Xypex may cause significant skin and eye irritation. Directions for treating these problems are clearly detailed on all Xypex pails and packaging. The Manufacturer also maintains comprehensive and up-to-date Safety Data Sheets on all its products. Each sheet contains health and safety information for the protection of workers and customers. The Manufacturer recommends you contact Xypex Chemical Corporation or your local Xypex Technical Services Representative to obtain copies of Safety Data Sheets prior to product storage or use.

Warranty

The Manufacturer warrants that the products manufactured by it shall be free from material defects and will be consistent with its normal high quality. Should any of the products be proven defective, the liability to the Manufacturer shall be limited to replacement of the product ex factory. The Manufacturer makes no warranty as to merchantability or fitness for a particular purpose and this warranty is in lieu of all other warranties expressed or implied. The user shall determine the suitability of the product for his intended use and assume all risks and liability in connection therewith.

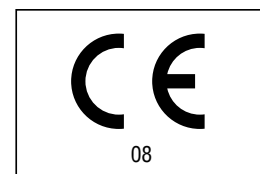

Description

Xypex is a unique chemical treatment for the waterproofing, protection and improvement of concrete. XYPEX ADMIX C-1000 RED is added to the concrete mix at the time of batching. Admix C-1000 Red consists of Portland cement, very fine silica sand, a red oxide pigment and various active, proprietary chemicals. These active chemicals react with the moisture in fresh concrete and with the by-products of cement hydration to cause a catalytic reaction which generates a non-soluble crystalline formation throughout the pores and capillary tracts of the concrete. Thus the concrete becomes permanently sealed against the penetration of water or liquids from any direction. The concrete is also protected from deterioration due to harsh environmental conditions.

Xypex Admix C-1000 Red

Admix C-1000 Red has been specially formulated to provide the unique Xypex crystalline waterproofing and protection, as well as a red oxide pigment to clearly identify concrete treated with the Xypex Admix. Refer to the relevant sections of this data sheet or consult with Xypex's Technical Services Department for assistance in determining the appropriate dosage rate and for further information regarding enhanced chemical resistance, optimum concrete performance (e.g. setting time, compressive strength), or meeting the specific requirements and conditions of your project.

Recommended for:

Precast Components

- manholes
- pipes
- culverts
- vaults
- septic tanks

Advantages

- Resists extreme hydrostatic pressure
- Becomes an integral part of the substrate
- Highly resistant to aggressive chemicals
- Can seal static hairline cracks up to 0.4 mm
- Allows concrete to breathe
- Non-toxic / no VOCs
- Less costly to install than most other methods
- Permanent
- Added to the concrete at time of batching and therefore is not subject to climatic restraints

Packaging

Xypex Admix C-1000 Red is packaged in 20 lb. (9.1 kg) pails and 37 lb. (16.8 kg) paper bags. For specific projects, contact Xypex Chemical Corporation for availability of custom sized packaging.

Storage

Xypex products must be stored dry at a minimum temperature of 45°F (7°C). Shelf life is one year when stored under proper conditions.

Dosage Rates

Xypex Admix C-1000 Red:

3 - 3.5% by weight of cement

Consult with the local Xypex Technical Services Representative or Xypex's Technical Services Department for assistance in determining the appropriate dosage rate and for further information regarding enhanced chemical resistance, optimum concrete performance, or meeting the specific requirements and conditions of your project.

Test Data

PERMEABILITY

U.S. Army Corps of Engineers CRD C48, "Permeability of Concrete", Aviles Engineering Corp., Houston, USA

Two concrete samples containing Xypex Admix and an untreated control sample were tested for water permeability. Both the treated and untreated samples were subjected to a pressure of 150 psi / 1.04 MPa (350 ft. / 106.7 m water head). Results showed moisture and permeated water throughout the untreated sample after 24 hours. However, the Xypex Admix samples showed no leakage, and water penetration of only 1.5 mm / 0.06 inches after 120 hours (5 days).

U.S. Army Corps of Engineers CRD C48, "Permeability of Concrete", Setsco Services, Pte Ltd., Singapore

Six Xypex Admix-treated and six untreated concrete samples were tested for water permeability. Pressure was gradually increased over five days and then maintained at 7 bars (224 ft. / 68.3 m water head) for 10 days. While the six reference samples showed water leakage beginning on the fifth day and increasing throughout the test period, the Xypex Admix samples showed no water leakage at any time during the test.

ACCI Water Permeability Test, “Water Permeability of Concrete”, Australia Centre of Construction and Innovation, University of New South Wales, Sydney, Australia

Concrete samples containing Xypex Admix NF at a dosage rate of 0.8% and 1.2% were tested for water permeability against control samples. All the samples were subjected to a pressure of 10 bars (100 meters / 328 ft. water head) for 2 weeks. Water permeability coefficients were calculated and the Xypex Admix-treated concrete showed significant reduction in water permeability by up to 93% at a dosage rate of 1.2%.

STN EN 12390-8 “Testing of Hardened Concrete; Depth of Water Penetration Under Pressure”, Technical and Testing Construction Institute, Bratislava, Slovakia

Concrete cubes were prepared with Admix C-1000 at 2% and Admix C-1000 NF at 1% along with control cubes. A water pressure of 0.5 MPa was applied for 72 hrs and specimens were subsequently split transversely to measure depth of water penetration. Depth results for C-1000/C-1000 NF were 10.3 mm and 25 mm respectively, whereas penetration on control samples was 113 mm. In using the Valenta equation to calculate the water permeability coefficient, the C-1000/C-1000 NF treated concrete showed a 20 to 120x reduction compared to the control concrete.

COMPRESSIVE STRENGTH

ASTM C 39, “Compressive Strength of Cylindrical Concrete Specimens”, Kleinfelder Laboratories, San Francisco, USA

At 28 days, the compressive strength test of the concrete containing Xypex Admix measured 7160 psi / 49.5 MPa as compared to the reference sample at 6460 psi / 44.5 MPa (a 10% increase).

CHEMICAL RESISTANCE

CSN 73 1326 “Measuring Loss of Surface Due to Sulphate Attack of Concrete Treated with Admix C-1000/Admix C-1000 NF”, Betonconsult, Building Materials Testing Laboratory, Prague, Czech Republic

Concrete specimens treated with Admix C-1000 at 1% and 2%, and Admix C-1000 NF at 0.5% and 1% were cast along with non-treated concrete specimens. The specimens were exposed to a highly concentrated sulphate solution (i.e. 36,000 mg/l) for 4 months and samples were periodically weighed to determine mass loss. The Admix treated samples recorded a mass loss between 5 and 50 g/m² and showed no surface deterioration, while the non-treated specimens measured an average mass loss of 4,860 g/m² with significant surface deterioration.

HB 84-2006 “Durability Assessment of Reinforced Concrete Structure Containing Xypex Admix Exposed to 19 Years of Severe Marine Environment”, Sharp and Howells Pty. Ltd., Chemical Laboratories, Victoria, Australia

Lascelles Wharf serves as a bulk chemical and grain dock. In 1995, as part of an extensive maintenance pro-

gram and to protect new precast concrete panels from the extremely harsh and aggressive marine environment, the concrete was dosed with Xypex Admix C-2000 NF at 1%. Recently tests were conducted to predict “initiation time to corrosion”. Extracted cores were tested for chloride content at incremental depths into the concrete. Chloride content profiles, concrete cover, surface chloride content, and chloride corrosion threshold were used in a model based on Fick’s 2nd law to predict the residual service life of this structure. The average initiation time to corrosion was estimated at 164 years; whereas, the structure had been designed for 50 years of service life.

NT BUILD 443, “Chloride Diffusion by NordTest with 16.5% NaCl Solution of 40 MPa Concrete Containing Admix C-1000 NF”, Australia Centre for Construction Innovation, University of New South Wales, Sydney, Australia

The NordTest NT BUILD 443 is a standard accelerated method for evaluation of the chloride diffusion coefficient of concrete. In this test program, concrete mixes with 25% fly ash, 38% slag, and 60% slag were cast (total cementitious content = 435 kg, 0.4 w/c). Xypex Admix C-1000 NF at 0.8% and 1.2% by weight of cementitious materials were compared to control mixes (for each cement system). All specimens were immersed in a 16.5% NaCl solution for 35 days. Chloride diffusion coefficient was calculated based on the chloride profile, utilizing Fick’s 2nd law. Admix treated fly ash concrete showed 25% reduced chloride diffusion coefficient for both 0.8% and 1.2% addition. The Admix treated 38% slag concrete recorded a 67% lower chloride diffusion coefficient at 0.8% addition and 75% lower at 1.2% addition. The reduction of chloride diffusion coefficient was 42% and 53% for high slag mixes for 0.8% and 1.2% addition respectively.

“Sulfuric Acid Resistance Test”, Aviles Engineering Corporation, Houston, USA

Concrete containing Xypex Admix at different dosage rates including 3% specimens were tested against untreated control samples for sulfuric acid resistance. After immersion in the sulfuric acid, each sample was tested for weight loss on a daily basis until a weight loss of 50% or a definite response trend was obtained. The percentage weight loss of the samples containing Xypex Admix tested significantly lower than the control samples.

“Acid Resistance of Mortar Containing Xypex Admix C-1000 NF”, Construction and Maintenance Technology Research Center (CONTEC), Sirindhorn International Institute of Technology (SIIT) - Thammasat University, Bangkok, Thailand

An acid testing regime was part of an extensive program to determine the benefit of the Xypex Admix C-1000 NF dosed at 1% to improve the durability of concrete. Several comparative mixes were utilized in this evaluation, including: a plain Portland cement and a 30% fly ash mix. Cured samples were exposed to 5% H₂SO₄; the pH value of this acid solution was 0.25 and never greater than 0.54 pH. In this extremely acidic, corrosive environment,

at 12 weeks the Admix samples reduced the weight loss by 48% compared to controls of the cement-only mortar, and 53% in the fly ash specimens.

CRACK SEALING

ASTM C1585 and ASTM C1202 “Evaluation of Self-healing Capability of Self-compacting Concrete Made with Blast-furnace Slag Cements Activated by the Xypex Crystalline Catalyst”, Instituto Tecnológico de Aeronautica, Sao Jose dos Campos, Brazil

Portland, blast furnace slag and slag-modified Portland concrete samples, treated with 2.5% Admix C-500, were evaluated for self-healing capabilities. Microcracks were induced by loading to 90% of ultimate compressive strength. Cracked samples were then immersed in water to trigger self-healing after 28, 56 and 84 days. Strength and ultrasonic pulse velocity tests were used to determine mechanical recovery; sorptivity and rapid chloride permeability were used to evaluate watertightness recovery. Results substantiated the ability of Xypex Admix to provide self-healing of cracked concrete.

“Testing of Xypex Admix C-1000 NF Crack Healing Capabilities”, CH Karnchang (Lao) Company Ltd., Xayaburi Laboratory, Ban Xieng Yeun, Vientiane, Laos
Prior to construction of a Mekong River dam, testing was undertaken to substantiate the ability of Xypex Admix to self-heal static cracks up to 0.4 mm. Three large concrete slabs treated with Admix C-1000 NF at 0.8% were cast along with three control slabs. Following curing, a force was applied at the mid-point of each slab to create cracks; on average measuring 0.4 mm width. Water was ponded above the cracked area. Initially all cracks leaked; at 4 days all dripping had ceased from the cracks of the Xypex treated panels, while leaking continued through the cracks of the control slab until the end of the test period (25 days). SEM photographs showed significant crystalline growth throughout the cracks of the Admix treated slab.

SCANNING ELECTRON MICROSCOPY

SEM “Microscopic Examination of Crystalline Products in Three Xypex Admix Modified Concrete Mortars”, Australian Centre for Construction Innovation, University of New South Wales, Sydney, Australia

Slag and fly ash blended cement samples were treated with Xypex Admix and examined for evidence of crystalline growth at ages ranging from 8 months to 2 years. Samples were sliced and/or split and examined at magnifications between 500x and 5000x. Characteristic Xypex crystalline growth was observable on all Xypex treated samples, providing evidence of Xypex crystalline reactions with fly ash and slag blended cements.

FREEZE/THAW DURABILITY

ASTM C 666, “Freeze/Thaw Durability”, Independent Laboratory, Cleveland, USA

After 300 freeze/thaw cycles, the Xypex Admix-treated samples indicated 94% relative durability.

Directions for Use

Xypex Admix C-1000 Red is added to the concrete at the time of batching. It is important to obtain a homogeneous mixture of Xypex Admix with the concrete. Do not add dry Admix powder directly to wet mixed concrete as this could cause clumping and thorough dispersion may not occur. The sequence of procedures for addition will vary according to the type of batch plant operation and equipment. The following methods have been used successfully in the past and it is recommended that the local Xypex Technical Services Representative be consulted about the best method to use.

1. ADDITION TO COARSE AGGREGATE BELT Add Xypex Admix powder directly to the coarse aggregate conveyor belt manually or through computer controlled mass batching system. Account for worker health and safety issues with moving belts and wind-blown dust issues.

2. ADDITION TO CENTRAL MIXER Load the Admix in bulk powder form along with the other components. Mix as per standard batching practices to ensure thorough dispersal of the Admix resulting in a homogeneous mixture. Account for worker safety issues when accessing the equipment.

3. TRUCK ADDITION (AT PLANT) Add Xypex Admix in bulk powder form to the drum of the ready-mix truck immediately prior to driving the truck under the batch plant and adding the balance of the materials in accordance with standard concrete batching practices. Avoid delays in adding other components and utilize high speed mixing to ensure homogeneity of mix. Where there may be insufficient water for thorough dispersion of the bulk powder, a water slurry can be made with the Admix and added to the truck mixer drum prior to batching. Account for added water in the mix design and slump.

Note:

i. For installations involving pan mixers, the recommended procedure would be to initially add some of the mix water and coarse aggregate to the pan mixer, begin mixing and slowly add the Xypex Admix powder. Mix until the Admix is thoroughly dispersed and forms a slurry, then add the balance of the materials and continue to mix as per normal.

ii. Concrete containing the Xypex Admix does not preclude the requirement for design of crack control, construction joint detailing, proper placement, consolidation and curing of the concrete and measures for repairing defects such as honeycombing, tie holes, cracks beyond specified limits.

iii. Further guidelines are available that address the use of Xypex Admix for a specific situation, (e.g. dry mixes, use of ice in hot ambient conditions, cold-weather concreting, etc.). Consult with a local Xypex Technical Services Representative or Xypex’s Technical Services Department for further information.

Setting Time and Strength

The setting time of concrete is affected by the chemical and physical composition of ingredients, temperature of the concrete and climatic conditions. Xypex Admix C-1000 Red is designed for concrete mix designs where a normal or mildly delayed set is desired. Concrete containing the Admix C-1000 Red may develop higher ultimate strengths than plain concrete. Trial mixes should be carried out under project conditions to determine the setting time and strength of the concrete dosed with Admix C-1000 Red. Consult with a Xypex Technical Services Representative for the most appropriate Xypex Admix for your project.

Limitations

When incorporating Xypex Admix, the temperature of the concrete mix should be above 40°F (4°C).

Technical Services

For more instructions, alternative installation methods, or information concerning the compatibility of the Xypex treatment with other products or technologies, contact the Technical Services Department of Xypex Chemical Corporation or your local Xypex Technical Services Representative.

Safe Handling Information

Xypex is alkaline. As a cementitious powder or mixture, Xypex may cause significant skin and eye irritation. Directions for treating these problems are clearly detailed on all Xypex pails and packaging. The Manufacturer also maintains comprehensive and up-to-date Safety Data Sheets on all its products. Each sheet contains health and safety information for the protection of workers and customers. The Manufacturer recommends you contact Xypex Chemical Corporation or your local Xypex Technical Services Representative to obtain copies of Safety Data Sheets prior to product storage or use.

Warranty

The Manufacturer warrants that the products manufactured by it shall be free from material defects and will be consistent with its normal high quality. Should any of the products be proven defective, the liability to the Manufacturer shall be limited to replacement of the product ex factory. The Manufacturer makes no warranty as to merchantability or fitness for a particular purpose and this warranty is in lieu of all other warranties expressed or implied. The user shall determine the suitability of the product for his intended use and assume all risks and liability in connection therewith.

Description

Xypex Concentrate is a unique chemical treatment for the waterproofing and protection of concrete. XYPEX CONCENTRATE DS-1 is a special formulation designed specifically for a dry-shake application on horizontal concrete surfaces. Packaged in the form of a dry powder compound, Concentrate DS-1 consists of Portland cement, various active proprietary chemicals, and an aggregate which has been crushed and graded to particle sizes suitable for concrete floors. DS-1 becomes an integral part of the concrete surface thereby eliminating problems normally associated with coatings (e.g. scaling, dusting, flaking and delamination). The active chemicals react with the moisture of the fresh concrete causing a catalytic reaction which generates a non-soluble crystalline formation within the pores and capillary tracts of the concrete.

Recommended for:

- Sewage and Water Treatment Plants
- Reservoirs
- Foundation Slabs
- Bridge Decks
- Below-grade Parking Structures

Note: For concrete surfaces that are subject to heavy traffic conditions or that require increased resistance to impact and abrasion, please consult with a Xypex Technical Services Representative regarding the use of Xypex Concentrate DS-2.

Advantages

- Resists extreme hydrostatic pressure from either positive or negative surface of the concrete slab
- Becomes an integral part of the substrate
- Highly resistant to aggressive chemicals
- Can seal static hairline cracks up to 0.4 mm
- Allows concrete to breathe
- Non-toxic / no VOCs
- Less costly to apply than most other methods
- Permanent
- Increases flexibility in the construction schedule

Packaging

Xypex Concentrate DS-1 is available in 60 lb. (27.2 kg) pails.

Storage

Xypex products must be stored dry at a minimum temperature of 45°F (7°C). Shelf life is one year when stored under proper conditions.

Coverage

Under normal conditions, the coverage rate for Xypex Concentrate DS-1 is 1.75 lb./sq. yd. (0.95 kg/m²).

Test Data

PERMEABILITY

U.S. Army Corps of Engineers (USACE) CRD C48, "Permeability of Concrete", Pacific Testing Labs, Seattle, USA

Two in. (51 mm) thick, 2000 psi (13.8 MPa) Xypex-treated concrete samples were pressure tested up to a 405 ft. (124 m) water head (175 psi/1.2 MPa), the limit of the testing apparatus. While untreated samples showed marked leakage, the Xypex-treated samples (as a result of the crystallization process) became totally sealed and exhibited no measurable leakage.

DIN 1048 (equivalent to EN 12390-8), "Water Impermeability of Concrete", Bautest – Corporation for Research & Testing of Building Materials, Augsburg, Germany

Twenty cm thick Xypex-treated concrete samples were pressure tested up to 7 bars (230 ft./70 m water head) for 24 hours to determine water impermeability. While the reference specimens measured water penetration up to a depth of 92 mm, Xypex-treated samples measured water penetration of zero to an average of 4 mm.

EN 12390-8, "Depth of Water Penetration on Samples Treated with Concentrate Coating", OL-123, Czech Technical University, Prague, Czech Republic

Three replicate 150 mm concrete cubes from four different mix designs (strength classes) were coated with Xypex Concentrate at a thickness of 0.8 mm to 1 mm. Controls for each of the different mix designs were also cast for comparison purposes. All samples were exposed to 0.5 MPa (73 psi) of water pressure for 72 hours from the opposite side of the treated surface. Specimens from each set were split transversely from the treated surface at 28 and 91 days to measure depth of water penetration from the exposed surface. After 28 days, the Xypex coating reduced the depth of water penetration by 90 to 94% compared to the control mixes for the four mix types. At 91 days all Xypex-treated samples measured <1 mm of water penetration.

DEPTH OF PENETRATION

"Measurement of Mass Concrete Humidity", Czech Technical University, (CVUT) Faculty of Civil Engineering, Prague, Czech Republic

A coating of Xypex Concentrate was applied to one face of a 300 mm x 300 mm x 220 mm set of concrete blocks; two replicate sets of blocks were left untreated. Water

filled containers were tightly sealed onto the opposite face of the treated blocks and one set of the untreated blocks while the third untreated block set was kept in the laboratory as a control. Humidity probes were installed in 6 mm diameter holes that were drilled to within 30 - 40 mm of the water exposed surface. Mass humidity was recorded at intervals of 28, 45, 90, 125 and 132 days. Final results showed that the Xypex-treated specimens had an average humidity reading of 4.6%, the untreated sample measured 7.9% and the control block with no water exposure was 4.4%, essentially equivalent to the Xypex specimens' results. The Xypex reactive chemicals had diffused at least 190 mm in 132 days.

“An Enhancement in the Nature of Concrete with a Multiplicative Cement Crystal-Type Concrete Material”, Central Research Laboratory of Nikki Shoji in association with Hosei University, Japan



A 60 cm x 70 cm x 40 cm concrete block was cast and a Concentrate coating was applied to the surface and cured. The block was left outdoors for approximately 1 year. Subsequently, a 40 cm (15.75 in.) long cylinder was then cored perpendicular to the Xypex treatment and cut into 18 slices of equal length.

SEM photographs utilizing a 1000x magnification were taken of slices from various depths from the treated surface to determine the extent of crystalline growth. While the crystalline structure was most dense in specimens located closest to the treated surface, there was evidence of the crystalline structure at 30 cm (12 inches) from the treated surface.

CRACK SEALING

ASTM C856 “Standard Practice for Petrographic Examination of Hardened Concrete”, Setsco Services Pte, Ltd., Singapore

A coat of Xypex Concentrate was applied to a slab that had developed numerous hairline cracks. To determine the crack sealing ability of the Xypex treatment, cores were extracted from a slab at 3, 10, 14 and 20 days following application. Thin sections were taken from each core in order to examine hairline cracks utilizing a polarizing and fluorescent microscope (PFM). In each case, there was evidence of the Xypex crystalline structure in the cracks to a depth of about 20 mm. Photographs taken this depth at 100x magnification showed the Xypex crystalline structure had reduced the width of the cracks dramatically.

CHEMICAL RESISTANCE

ASTM C 267, “Chemical Resistance to Mortars”, Pacific Testing Labs, Seattle, USA

Xypex-treated cylinders and untreated cylinders were exposed to hydrochloric acid, caustic soda, toluene, mineral oil, ethylene glycol, pool chlorine, brake fluid and other chemicals. Results indicated that chemical exposure did not have any detrimental effects on the Xypex

coating. Tests following chemical exposure measured an average 17% higher compressive strength in the Xypex-treated specimens over the untreated control samples.

IWATE University Technical Report, “Resistance to Acid Attack”, Tokyo, Japan



Xypex-treated mortar and untreated mortar were measured for acid resistance after exposure to a 5% H₂SO₄ solution for 100 days. Xypex suppressed concrete erosion to 1/8 of the reference samples.

ASTM C876 “Influence of Xypex Coating System on Residual Service Life of Concrete Structures” Durability Assessment Section, Xypex Australia

A bridge pier exposed to seawater in a tidal splash zone for over 40 years experienced different types of deterioration mechanisms including surface abrasion (skin loss), cracking, and corrosion of steel reinforcement. Corrosion monitoring was conducted before and six months after application of Xypex Concentrate. This non-destructive testing (NDT) included a measurement of the corrosion rate, corrosion potential, and concrete resistivity. Results indicated a reduction of corrosion rate and corrosion potential up to 50% and 40% respectively, and significant enhancement of the concrete resistivity.

RILEM CPC-18 “Carbonation Resistance of Samples Treated with a Xypex Concentrate Coating”, Construction and Maintenance Technology Research Center (CONTEC), Sirindhorn International Institute of Technology (SIIT) – Thammasat University, Bangkok, Thailand

Control and Xypex Concentrate coated samples were carbonated in an accelerated carbonation chamber. The average depths of carbonation were measured at 28, 56, 77 and 91 days. The depth of carbonation of these Xypex Concentrate coated samples was reduced by 35 - 40% compared to the controls. Following initial carbonation, one set of samples was coated with Xypex Concentrate to model old concrete already damaged by carbonation. For these specimens, testing indicated that carbonation was arrested and in one specimen reduced.

FREEZE/THAW DURABILITY

ASTM C 672, “Standard Test Method for Scaling Resistance of Concrete Surfaces Exposed to De-Icing Chemicals”, Twin City Testing Lab, St. Paul, USA

Xypex-treated samples restricted chloride ion concentration to below the level necessary to promote electrolytic corrosion of reinforcing steel. Visual examination of untreated panels after 50 freeze/thaw cycles showed a marked increase in surface deterioration compared to Xypex-treated samples.

RADIATION RESISTANCE

U.S.A. Standard No. N69, "Protective Coatings for the Nuclear Industry", Pacific Testing Labs, Seattle, USA

After exposure to 5.76×10^4 rads of gamma radiation, the Xypex treated specimens displayed no ill effects.

Application Procedures

1. Fresh concrete is placed, consolidated and levelled.
2. Wait until concrete can be walked on leaving an indentation of 1/4 - 3/8 in. (6.5 - 9.5 mm). Concrete should be free of bleed water and be able to support the weight of a power trowel. Then, float open the surface.
3. Immediately after floating open the surface, apply the dry shake material by hand or mechanical spreader. The dry shake material must be spread evenly.
4. As soon as the dry shake material has absorbed moisture from the base slab, it must be floated into the surface. The DS-1 powder must be thoroughly worked into the cement paste using a float (not a trowel). Failure to utilize a float for this process could result in damage to the hardened surface (i.e. flaking, blistering or peeling).
5. When concrete has hardened sufficiently, power trowel surface to the required finish.

Note:

- i. Environmental conditions (e.g. hot or cold temperatures) may affect the application and installation of the Dry Shake powder. In hot, dry or windy conditions where evaporation of bleed water is occurring, the DS-1 powder should be applied immediately after Step 1 above (i.e. screeding). Keep top of slab from premature drying to ensure homogeneous mixture of DS-1 powder into concrete paste. It is advisable to use an evaporation retardant on the fresh concrete.
- ii. It is common that edges of a slab wall will set up earlier than the main body of concrete. Such edge areas can be dry-shaked and finished with hand tools prior to proceeding with application to the main body of concrete.
- iii. Consult with Xypex's Technical Services Department or your local Xypex Technical Services Representative regarding the optimum concrete performance under a variety of conditions during application of DS-1.

Curing

Curing is important and should begin as soon as final set has occurred but before surface starts to dry. Conventional moist curing procedures such as water spray, wet burlap or plastic covers may be used. Curing should continue for at least 48 hours. In hot, dry, sunny conditions, consult manufacturer for specific instructions. In lieu of moist curing, concrete sealers and curing compounds meeting ASTM C 309 may be used.

Note:

1. For best results when applying dry shake materials, the air content of the concrete should not exceed 3% (a high air content can make it difficult to achieve a proper application). If a higher entrained air content is specified (e.g. for concrete that will be exposed to freezing and thawing), contact the Technical Services Department of Xypex Chemical Corporation for further application information.
2. Chronic moving cracks or joints will require a suitable flexible sealant.
3. For certain concrete mix designs, we recommend a test panel be produced and evaluated for finishing. For example, higher performance concrete with a low water/cement ratio, air entrainment, superplasticizers, or silica fume may reduce bleed water and make the concrete more difficult to finish.
4. For increased abrasion resistance, spray-apply Xypex Quickset following curing of the DS-1 application. The Xypex Quickset mix ratio is one part Quickset to one part water by volume. The recommended coverage rate is 150 ft.²/U.S. gallon (14 m²/litre).

Technical Services

For more instructions, alternative installation methods, or information concerning the compatibility of the Xypex treatment with other products or technologies, contact the Technical Services Department of Xypex Chemical Corporation or your local Xypex Technical Services Representative.

Safe Handling Information

Xypex is alkaline. As a cementitious powder or mixture, Xypex may cause significant skin and eye irritation. Directions for treating these problems are clearly detailed on all Xypex pails and packaging. The Manufacturer also maintains comprehensive and up-to-date Safety Data Sheets on all its products. Each sheet contains health and safety information for the protection of workers and customers. The Manufacturer recommends you contact Xypex Chemical Corporation or your local Xypex Technical Services Representative to obtain copies of Safety Data Sheets prior to product storage or use.

Warranty

The Manufacturer warrants that the products manufactured by it shall be free from material defects and will be consistent with its normal high quality. Should any of the products be proven defective, the liability to the Manufacturer shall be limited to replacement of the product ex factory. The Manufacturer makes no warranty as to merchantability or fitness for a particular purpose and this warranty is in lieu of all other warranties expressed or implied. The user shall determine the suitability of the product for his intended use and assume all risks and liability in connection therewith.

Description

Xypex Concentrate is a unique chemical treatment for the waterproofing and protection of concrete. XYPEX CONCENTRATE DS-2 is a special formulation designed specifically for a dry-shake application on horizontal concrete surfaces where greater resistance to impact and abrasion is required. Packaged in the form of a dry powder compound, Concentrate DS-2 consists of Portland cement, various active proprietary chemicals, and a synthetic aggregate hardener which has been crushed and graded to particle sizes suitable for concrete floors. DS-2 becomes an integral part of the concrete surface thereby eliminating problems normally associated with coatings (e.g. scaling, dusting, flaking and delamination). The active chemicals react with the moisture of the fresh concrete causing a catalytic reaction which generates a non-soluble crystalline formation within the pores and capillary tracts of the concrete.

Recommended for:

- Sewage and Water Treatment Plants
- Traffic Bearing Surfaces
- Warehouse Floors
- Foundation Slabs
- Below-grade Parking Structures

Advantages

- Resists extreme hydrostatic pressure from either positive or negative surface of the concrete slab
- Becomes an integral part of the substrate
- Highly resistant to aggressive chemicals
- Can seal static hairline cracks up to 0.4 mm
- Allows concrete to breathe
- Non-toxic / no VOCs
- Less costly to apply than most other methods
- Permanent
- Increases flexibility in the construction schedule

Packaging

Xypex Concentrate DS-2 is available in 60 lb. (27.2 kg) pails.

Storage

Xypex products must be stored dry at a minimum temperature of 45°F (7°C). Shelf life is one year when stored under proper conditions.

Coverage

Under normal conditions, the coverage rate for Xypex Concentrate DS-2 is 6.75 - 7.5 lb./sq. yd. (3.6 - 4.0 kg/m²), depending on the degree of abrasion resistance required.

Note: Under heavy traffic conditions or where even greater abrasion resistance is required, consult with a Xypex Technical Services Representative for a recommendation that meets your specific need.

Test Data

PERMEABILITY

U.S. Army Corps of Engineers (USACE) CRD C48, "Permeability of Concrete", Pacific Testing Labs, Seattle, USA

Two in. (51 mm) thick, 2000 psi (13.8 MPa) Xypex-treated concrete samples were pressure tested up to a 405 ft. (124 m) water head (175 psi/1.2 MPa), the limit of the testing apparatus. While untreated samples showed marked leakage, the Xypex-treated samples (as a result of the crystallization process) became totally sealed and exhibited no measurable leakage.

DIN 1048 (equivalent to EN 12390-8), "Water Impermeability of Concrete", Bautest – Corporation for Research & Testing of Building Materials, Augsburg, Germany

Twenty cm thick Xypex-treated concrete samples were pressure tested up to 7 bars (230 ft./70 m water head) for 24 hours to determine water impermeability. While the reference specimens measured water penetration up to a depth of 92 mm, Xypex-treated samples measured water penetration of zero to an average of 4 mm.

EN 12390-8, "Depth of Water Penetration on Samples Treated with Concentrate Coating", OL-123, Czech Technical University, Prague, Czech Republic

Three replicate 150 mm concrete cubes from four different mix designs (strength classes) were coated with Xypex Concentrate at a thickness of 0.8 mm to 1 mm. Controls for each of the different mix designs were also cast for comparison purposes. All samples were exposed to 0.5 MPa (73 psi) of water pressure for 72 hours from the opposite side of the treated surface. Specimens from each set were split transversely from the treated surface at 28 and 91 days to measure depth of water penetration from the exposed surface. After 28 days, the Xypex coating reduced the depth of water penetration by 90 to 94% compared to the control mixes for the four mix types. At 91 days all Xypex-treated samples measured <1 mm of water penetration.

DEPTH OF PENETRATION

"Measurement of Mass Concrete Humidity", Czech Technical University, (CVUT) Faculty of Civil Engineering, Prague, Czech Republic

A coating of Xypex Concentrate was applied to one face of a 300 mm x 300 mm x 220 mm set of concrete blocks;

two replicate sets of blocks were left untreated. Water filled containers were tightly sealed onto the opposite face of the treated blocks and one set of the untreated blocks while the third untreated block set was kept in the laboratory as a control. Humidity probes were installed in 6 mm diameter holes that were drilled to within 30 - 40 mm of the water exposed surface. Mass humidity was recorded at intervals of 28, 45, 90, 125 and 132 days. Final results showed that the Xypex-treated specimens had an average humidity reading of 4.6%, the untreated sample measured 7.9% and the control block with no water exposure was 4.4%, essentially equivalent to the Xypex specimens' results. The Xypex reactive chemicals had diffused at least 190 mm in 132 days.

“An Enhancement in the Nature of Concrete with a Multiplicative Cement Crystal-Type Concrete Material”, Central Research Laboratory of Nikki Shoji in Association with Hosei University, Japan



A 60 cm x 70 cm x 40 cm concrete block was cast and a Concentrate coating was applied to the surface and cured. The block was left outdoors for approximately 1 year. Subsequently, a 40 cm (15.75 in.) long cylinder was then cored perpendicular to the Xypex treatment and cut into 18 slices of equal length.

SEM photographs utilizing a 1000x magnification were taken of slices from various depths from the treated surface to determine the extent of crystalline growth. While the crystalline structure was most dense in specimens located closest to the treated surface, there was evidence of the crystalline structure at 30 cm (12 inches) from the treated surface.

CRACK SEALING

ASTM C856 “Standard Practice for Petrographic Examination of Hardened Concrete”, Setsco Services Pte, Ltd., Singapore

A coat of Xypex Concentrate was applied to a slab that had developed numerous hairline cracks. To determine the crack sealing ability of the Xypex treatment, cores were extracted from a slab at 3, 10, 14 and 20 days following application. Thin sections were taken from each core in order to examine hairline cracks utilizing a polarizing and fluorescent microscope (PFM). In each case, there was evidence of the Xypex crystalline structure in the cracks to a depth of about 20 mm. Photographs taken this depth at 100x magnification showed the Xypex crystalline structure had reduced the width of the cracks dramatically.

CHEMICAL RESISTANCE

ASTM C 267, “Chemical Resistance to Mortars”, Pacific Testing Labs, Seattle, USA

Xypex-treated cylinders and untreated cylinders were exposed to hydrochloric acid, caustic soda, toluene, mineral oil, ethylene glycol, pool chlorine, brake fluid and other chemicals. Results indicated that chemical exposure did not have any detrimental effects on the Xypex

coating. Tests following chemical exposure measured an average 17% higher compressive strength in the Xypex-treated specimens over the untreated control samples.

IWATE University Technical Report, “Resistance to Acid Attack”, Tokyo, Japan



Xypex-treated mortar and untreated mortar were measured for acid resistance after exposure to a 5% H₂SO₄ solution for 100 days. Xypex suppressed concrete erosion to 1/8 of the reference samples.

ASTM C876 “Influence of Xypex Coating System on Residual Service Life of Concrete Structures” Durability Assessment Section, Xypex Australia

A bridge pier exposed to seawater in a tidal splash zone for over 40 years experienced different types of deterioration mechanisms including surface abrasion (skin loss), cracking, and corrosion of steel reinforcement. Corrosion monitoring was conducted before and six months after application of Xypex Concentrate. This non-destructive testing (NDT) included a measurement of the corrosion rate, corrosion potential, and concrete resistivity. Results indicated a reduction of corrosion rate and corrosion potential up to 50% and 40% respectively, and significant enhancement of the concrete resistivity.

RILEM CPC-18 “Carbonation Resistance of Samples Treated with a Xypex Concentrate Coating”, Construction and Maintenance Technology Research Center (CONTEC), Sirindhorn International Institute of Technology (SIIT) – Thammasat University, Bangkok, Thailand

Control and Xypex Concentrate coated samples were carbonated in an accelerated carbonation chamber. The average depths of carbonation were measured at 28, 56, 77 and 91 days. The depth of carbonation of these Xypex Concentrate coated samples was reduced by 35 - 40% compared to the controls. Following initial carbonation, one set of samples was coated with Xypex Concentrate to model old concrete already damaged by carbonation. For these specimens, testing indicated that carbonation was arrested and in one specimen reduced.

FREEZE/THAW DURABILITY

ASTM C 672, “Standard Test Method for Scaling Resistance of Concrete Surfaces Exposed to De-Icing Chemicals”, Twin City Testing Lab, St. Paul, USA

Xypex-treated samples restricted chloride ion concentration to below the level necessary to promote electrolytic corrosion of reinforcing steel. Visual examination of untreated panels after 50 freeze/thaw cycles showed a marked increase in surface deterioration compared to Xypex-treated samples.

RADIATION RESISTANCE

U.S.A. Standard No. N69, "Protective Coatings for the Nuclear Industry", Pacific Testing Labs, Seattle, USA

After exposure to 5.76×10^4 rads of gamma radiation, the Xypex treatment revealed no ill effects or damages.

ABRASION RESISTANCE

ASTM C 501-84, "Taber Abrasion", AGRA Earth & Environment Ltd./James Neill & Associates, Vancouver, Canada

Since 1978 various tests have been performed on concrete specimens containing the non-metallic/synthetic hardener utilized in Xypex DS-2. Testing included the evaluation of concrete specimens for abrasion resistance as measured by mass loss (Taber Abrasion). The concrete control samples used in the tests exhibited an average mass loss of 6.0 grams, while subsequent taber abrasion testing of concrete treated with Xypex DS-2 showed a mass loss of 3.3 grams. Xypex Quickset was then applied to samples treated with Xypex DS-2 and mass loss was further reduced to 2.2 grams. Test results indicate that use of Xypex DS-2 significantly improves the abrasion resistance of concrete.

Application Procedures

1. Fresh concrete is placed, consolidated and levelled.
2. Wait until concrete can be walked on leaving an indentation of 1/4 - 3/8 in. (6.5 - 9.5 mm). Concrete should be free of bleed water and be able to support the weight of a power trowel. Then, float open the surface.
3. Immediately after floating open the surface, apply one-half of the dry shake material by hand or mechanical spreader. The dry shake material must be spread evenly.
4. As soon as the dry shake material has absorbed moisture from the base slab, it must be floated into the surface. The DS-2 powder must be thoroughly worked into the cement paste using a float (not a trowel). Failure to utilize a float for this process could result in damage to the hardened surface (i.e. flaking, blistering or peeling).
5. Immediately after power floating, apply remaining dry shake material at right angles to the first application.
6. Allow remaining dry shake material to absorb moisture from the base slab and then power float the material into the surface. Again, it is essential that the DS-2 powder is thoroughly worked into the cement paste using a float (not a trowel).
7. When concrete has hardened sufficiently, power trowel surface to the required finish.

Note:

i. Environmental conditions (e.g. hot or cold temperatures) may affect the application and installation of the Dry Shake powder. In hot, dry or windy conditions where

evaporation of bleed water is occurring, the DS-2 powder should be applied immediately after Step 1 above (i.e. screeding). Keep top of slab from premature drying to ensure homogeneous mixture of DS-2 powder into concrete paste. It is advisable to use an evaporation retardant on the fresh concrete.

ii. It is common that edges of a slab wall will set up earlier than the main body of concrete. Such edge areas can be dry-shaked and finished with hand tools prior to proceeding with application to the main body of concrete.

iii. Consult with Xypex's Technical Services Department or your local Xypex Technical Services Representative regarding the optimum concrete performance under a variety of conditions during application of DS-2.

Curing

Curing is important and should begin as soon as final set has occurred but before surface starts to dry. Conventional moist curing procedures such as water spray, wet burlap or plastic covers may be used. Curing should continue for at least 48 hours. In hot, dry, sunny conditions, consult manufacturer for specific instructions. In lieu of moist curing, concrete sealers and curing compounds meeting ASTM C 309 may be used.

Note:

1. For best results when applying dry shake materials, the air content of the concrete should not exceed 3% (a high air content can make it difficult to achieve a proper application). If a higher entrained air content is specified (e.g. for concrete that will be exposed to freezing and thawing), contact the Technical Services Department of Xypex Chemical Corporation for further application information.
2. Chronic moving cracks or joints will require a suitable flexible sealant.
3. For certain concrete mix designs, we recommend a test panel be produced and evaluated for finishing. For example, higher performance concrete with a low water/cement ratio, air entrainment, superplasticizers, or silica fume may reduce bleed water and make the concrete more difficult to finish.
4. To further enhance the surface, spray-apply Xypex Quickset following curing of the DS-2 application. The Xypex Quickset mix ratio is one part Quickset to one part water by volume. The recommended coverage rate is 150 ft.²/U.S. gallon (14 m²/litre).

Technical Services

For more instructions, alternative application / curing methods, or information concerning the compatibility of the Xypex treatment with other products or technologies, contact the Technical Services Department of Xypex Chemical Corporation or your local Xypex Technical Services Representative.

Safe Handling Information

Xypex is alkaline. As a cementitious powder or mixture, Xypex may cause significant skin and eye irritation. Directions for treating these problems are clearly detailed on all Xypex pails and packaging. The Manufacturer also maintains comprehensive and up-to-date Safety Data Sheets on all its products. Each sheet contains health and safety information for the protection of workers and customers. The Manufacturer recommends you contact Xypex Chemical Corporation or your local Xypex Technical Services Representative to obtain copies of Safety Data Sheets prior to product storage or use.

Warranty

The Manufacturer warrants that the products manufactured by it shall be free from material defects and will be consistent with its normal high quality. Should any of the products be proven defective, the liability to the Manufacturer shall be limited to replacement of the product ex factory. The Manufacturer makes no warranty as to merchantability or fitness for a particular purpose and this warranty is in lieu of all other warranties expressed or implied. The user shall determine the suitability of the product for his intended use and assume all risks and liability in connection therewith.

Description

XYPEX PATCH'N PLUG is a specially designed, fast-setting, hydraulic cement compound for concrete patching and repair. Patch'n Plug stops flowing water in seconds and is used to seal cracks, tie holes, and other defects in concrete. The sealing performance characteristics of Patch'n Plug are enhanced by Xypex's unique crystalline waterproofing technology.

Recommended for:

- Stopping an active flow of water through cracks and defects in substrate
- Repair of tie holes, honeycombs and rock pockets
- Repair of leaking construction joints
- Sealing around pipe penetrations

Advantages

- Single component (simply add water)
- Very rapid setting
- Contains Xypex's unique crystalline chemistry for self-healing of cracks and other defects
- Quick return to service of water holding structures
- Cement based – compatible with concrete and masonry substrates
- Non-toxic / no VOCs

Packaging

Xypex Patch'n Plug is available in 20 lb. (9.1 kg) pails and 60 lb. (27.2 kg) pails.

Storage

Xypex products must be stored dry at a minimum temperature of 45°F (7°C). Shelf life is one year when stored under proper conditions.

Coverage

One 60 lb. (27.2 kg) pail of Xypex Patch'n Plug will produce 0.54 cubic feet (0.0154 cu. metres) of mortar.

Test Data

Physical Property	Test Method	Laboratory Test Results	
Setting Time	ASTM C266	min:sec	
Initial Set Final Set		1:30 to 4:00 4:30 to 9:00	
Compressive Strength	ASTM C109	psi	MPa
@ 24 hours @ 28 days		1740 3630	12 25
Tensile Bond Pull-Off	CSA A23.2-6B	psi	MPa
		120	0.8
Note: Samples prepared with 1 part water to 3.25 part dry powder by volume. Results may vary significantly based on environmental, project and other conditions.			

Plugging Instructions

1. PREPARATION Chip out crack or other defects to a depth of 1.5 inches (37 mm) and a width of 1 inch (25 mm). The slot may be saw cut instead of chipped but ensure that the slot is dovetailed or otherwise shaped such that there will be mechanical interlock of materials placed into the slot at a later stage; a "V" shaped slot is not acceptable. Do not cut rebar when creating slot. Flush away all loose materials and dirt from the cavity with water and a stiff brush.

2. MIXING Add 1 part water to 3.25 - 3.5 parts Patch'n Plug by volume and mix to the consistency of a stiff putty. Do not mix more than can be used in 3 minutes. For best results, water temperature should be approximately 60°F - 70°F (15°C - 20°C).

3. PLUGGING Form plug with gloved hand. Place plug into cavity pressing firmly until plug is hard. When sealing cracks, begin at the point of lowest water flow and work towards the point with greatest water flow.

Note: Where there is a high volume of water flow due to extreme hydrostatic pressure, a bleeder hose may be necessary to relieve the water pressure while sealing the repair area. (See procedures on the next page).

a. With a hammer drill or chipping gun, if it is possible, without damaging the rebar, deepen the slot an additional 1 inch (25 mm) at the point of greatest water flow.

b. Place a stiff section of hose or pipe into the cavity and secure in place with Patch'n Plug to force water through the hose. Stop the water flow in the remainder of the slot per the directions above (i.e. form plug with gloved hand and press plug firmly into the cavity until it is hard.) This relieves the pressure so that the area can be patched. Allow a minimum of 24 hours for hardening.

c. Remove bleeder hose and plug remaining hole. If necessary, reduce water flow by inserting steel wool or wooden plug in the remaining hole before patching.

Patching Instructions

1. SURFACE PREPARATION Chip out faulty concrete until sound substrate is reached. Remove all loose materials from area and saturate with clean water. Allow water to be absorbed into the concrete, then remove excess water.

2. MIXING For fast repairs to concrete or masonry, add water to Patch'n Plug powder (1 part water to 3 - 3.5 parts powder by volume). Mix to a workable mortar consistency and trowel on as required. For large repairs, we recommend utilizing Xypex Megamix II. Alternatively, mix 2 parts Patch'n Plug powder with 1 part mason sand or small aggregate (3/8 in. or 10 mm minus crushed stone); utilize a similar water / powder ratio as above to create a workable mortar.

Abnormal Temperatures

During above normal ambient temperatures, mixing water should not exceed 90°F (32°C) and Xypex Patch'n Plug material should not exceed 70°F (21°C). Below normal ambient temperatures will retard the setting time of Patch'n Plug. In this situation, Xypex materials should be stored at normal temperatures (see Storage). Temperature of mixing water can be moderated to either increase or decrease the set time. Do not use Patch'n Plug where the substrate's temperature is below 40°F (4°C). Contact the Technical Services Department of Xypex for your particular application.

Technical Services

For more instructions, alternative installation methods, or information concerning the compatibility of the Xypex treatment with other products or technologies, contact the Technical Services Department of Xypex Chemical Corporation or your local Xypex Technical Services Representative.

Certification

Xypex Patch'n Plug satisfies the requirements of EN 1504-3; Initial Type Testing (ITT) according to EN 1504-3 was certified by BSI as the Notifying Body.

Safe Handling Information

Xypex is alkaline. As a cementitious powder or mixture, Xypex may cause significant skin and eye irritation. Directions for treating these problems are clearly detailed on all Xypex pails and packaging. The Manufacturer also maintains comprehensive and up-to-date Safety Data Sheets on all its products. Each sheet contains health and safety information for the protection of workers and customers. The Manufacturer recommends you contact Xypex Chemical Corporation or your local Xypex Technical Services Representative to obtain copies of Safety Data Sheets prior to product storage or use.

Warranty

The Manufacturer warrants that the products manufactured by it shall be free from material defects and will be consistent with its normal high quality. Should any of the products be proven defective, the liability to the Manufacturer shall be limited to replacement of the product ex factory. The Manufacturer makes no warranty as to merchantability or fitness for a particular purpose and this warranty is in lieu of all other warranties expressed or implied. The user shall determine the suitability of the product for his intended use and assume all risks and liability in connection therewith.

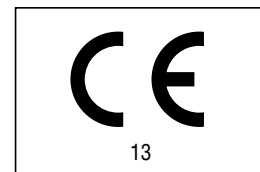

Description

XYPEX MEGAMIX I is a thin parge coat for the waterproofing and resurfacing of vertical masonry or concrete surfaces, as a cap coat for Xypex Concentrate, or as an architectural rendering. Megamix I is a unique blend of Portland cement, treated silica sand, fibers and proprietary chemicals. It is mixed with Xycrylic Admix to produce enhanced bond. Megamix I is applied by brush, trowel or spray up to a thickness of 3/8 in. (10 mm). The high performance characteristics of Megamix I are enhanced by Xypex's unique crystalline waterproofing and protection technology.

Note: For patching or resurfacing deteriorated concrete, requiring a thicker parge coat, (between 3/8 in. and 2 in. or 10 mm to 50 mm), refer to the product data sheet for Xypex Megamix II.

Recommended for:

- Waterproof coating for vertical concrete block surfaces and cast-in-place concrete walls
- A secondary or cap coat for Xypex Concentrate applications to porous masonry surfaces
- Lining for swimming pools, tunnels and tanks

Advantages

- Excellent adhesion and bond to concrete substrates
- Easy to apply
- Fiber reinforced
- Reduces surface absorption
- Provides good surface for painting or as a final finished surface
- Used as a cap-coat over Xypex Concentrate for rapid return to service applications
- Non-toxic / no VOCs
- NSF 61 certified

Packaging

Megamix I is available in 60 lb. (27.2 kg) pails.

Storage

Xypex products must be stored dry at a minimum temperature of 45°F (7°C). Shelf life is one year.

Coverage

Required coating thickness will vary depending on project requirements. At the recommended thickness of 1/8 in. (3.2 mm), one 60 lb. (27.2 kg) pail of Megamix I will cover 47.5 sq. ft. (4.4 m²). Megamix I may be applied as thin as 1/16 in. (1.6 mm) provided it is used as a cap

coat over a coat of Xypex Concentrate. For application thickness exceeding 3/8 in. (10 mm), consult with the Technical Services Department of Xypex Chemical Corporation or your local Xypex Technical Services Representative.

Laboratory Test Data

Physical Property	Test Method	Laboratory Test Results	
		psi	MPa
Compressive Strength	ASTM C109	psi	MPa
@ 7 days		2420	16.7
@ 28 days		3610	24.9
Tensile Bond Pull-Off	ACI 503R Appendix A	psi	MPa
Concrete Block		220	1.54
24 hr Concentrate		180	1.24
Water Permeability/Absorption	CSN 73 2578	87% reduction	
Note: Sample prepared with 1.4 U.S. gal. (5.4 litre) Xycrylic Admix per a 60 lb. (27.2 kg) pail of Megamix I. For bond and absorption, mixture was applied at 1/16" (1.6 mm) thick onto pressure washed surface. Results may vary significantly based on environmental, project and other conditions.			

Application Procedures

1. SURFACE PREPARATION Remove loose, delaminated or unsound concrete by high pressure water blast, grit blast or other means. The concrete surface to be treated with Megamix I must be clean and free from dirt, oil, paint, or other foreign substances that could hinder bond. Structural repairs (i.e. cracks, faulty construction joints, rock pockets, tie holes, spalled concrete, etc.) should be performed prior to the application of the Megamix I coating. A roughened, open capillary surface texture such as ICRI CSP 3 - 5 is typically required to achieve adequate bond.

2. WETTING CONCRETE SURFACE The concrete or masonry surface must be thoroughly saturated with clean water to control substrate suction. Maintain surface in saturated, surface dry (SSD) condition during application to prevent the premature drying out of the Megamix I coating.

3. MIXING PROCEDURES Prepare the mixing liquid by combining 1 part Xycrylic Admix with 2 parts clean water. Mix 1.4 - 1.5 U.S. gallons (5.4 - 5.7 litres) of the mixing liquid with one 60 lb. (27.2 kg) pail of Megamix I powder. Mix thoroughly to a creamy consistency. Let mixture stand for 3 - 5 minutes, re-agitate and then apply.

4. APPLYING MEGAMIX I Ensure surface is saturated, surface dry (SSD) just prior to application. Apply Megamix I at a rate of 0.6 to 1.3 lb./sq. ft. (2.9 to 6.4 m²) to produce a coating thickness of between 1/16 in. and 1/8 in. (1.6 mm to 3.2 mm) depending on the porosity of the substrate. For spray application contact the Technical Services Department of Xypex Chemical Corporation or your local Xypex Technical Services Representative for specific details.

For applications such as concrete block walls where Xypex Concentrate is to be used as the initial coat in a two-coat system, the Concentrate coating should be installed as per the manufacturer's standard instructions. The recommended application thickness for a cap-coat is 1/8 in. (3.2 mm). Megamix I should be applied over the Concentrate coating after the Concentrate has set and hardened for 12 - 24 hours. During this time, moist cure the Xypex Concentrate coating per the Xypex product data sheet instructions. Maintain the Concentrate coating in a SSD condition during the installation of the Megamix I as a cap-coat. The Megamix I coating should not be applied later than 48 hours after the application of Xypex Concentrate.

Note:

- i. Setting time can vary under differing ambient and concrete surface temperatures during application.
- ii. Megamix I should not be mixed and placed at temperatures below 39°F (3°C) or above 86°F (30°C). Contact the Technical Department of Xypex Chemical Corporation or your local Xypex Technical Services Representative for technical support in such situations.
- iii. Prior to the installation, it is recommended that a test section be completed under anticipated ambient and project conditions to demonstrate acceptable bond.

5. CURING When used with Xycrylic Admix as specified above, Megamix I should not require any further curing. However, if weather conditions result in rapid evaporation (such as very hot or windy), then after the Megamix I coating has fully set a fine mist of water should be sprayed on the coating 2 - 3 times for one day.

Technical Services

For more instructions, alternative application / curing methods, or information concerning the compatibility of the Xypex treatment with other products or technologies, contact the Technical Services Department of Xypex Chemical Corporation or your local Xypex Technical Services Representative.

Certification

Xypex Megamix I satisfies the requirements of EN 1504-3; Initial Type Testing (ITT) according to EN 1504-3 was certified by BSI as the Notifying Body.

Safe Handling Information

Xypex is alkaline. As a cementitious powder or mixture, Xypex may cause significant skin and eye irritation. Directions for treating these problems are clearly detailed on all Xypex pails and packaging. The Manufacturer also maintains comprehensive and up-to-date Safety Data Sheets on all its products. Each sheet contains health and safety information for the protection of workers and customers. The Manufacturer recommends you contact Xypex Chemical Corporation or your local Xypex Technical Services Representative to obtain copies of Safety Data Sheets prior to product storage or use.

Warranty

The Manufacturer warrants that the products manufactured by it shall be free from material defects and will be consistent with its normal high quality. Should any of the products be proven defective, the liability to the Manufacturer shall be limited to replacement of the product ex factory. The Manufacturer makes no warranty as to merchantability or fitness for the particular purpose and the warranty is in lieu of all other warranties expressed or implied. The user shall determine the suitability of the product for his intended use and assume all risks and liability in connection therewith.

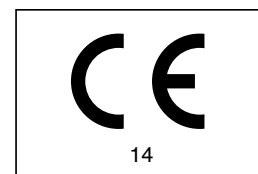

Description

XYPEX MEGAMIX II is a thick repair mortar for the patching and resurfacing of deteriorated concrete. Megamix II has been specifically formulated to produce superior bond, low shrinkage, chemical durability and high strength. It is a one component mortar and can be either sprayed or trowel applied at a thickness of 3/8 - 2 in. (10 - 50 mm) per layer. The high performance characteristics of Megamix II are enhanced by Xypex's unique crystalline waterproofing and protection technology.

Note: For rehabilitation applications, where a thin parge coating (less than 3/8 in. or 10 mm) or a cap coat for Xypex Concentrate is required, refer to the product data sheet for Megamix I.

Recommended for:

- Water Tanks and Reservoirs
- Water and Wastewater Treatment Plants
- Concrete Water and Sewer Pipes
- Manholes and Vaults
- Marine Structures
- Bridge Structures
- Tunnels and Parking Garages
- Foundations
- Hydro Dams and Thermal Electric Facilities

Advantages

- Excellent adhesion and bond to concrete substrates
- Resistant to chemical attack
- Low shrinkage, fiber reinforced
- Highly resistant to chloride diffusion
- Ready to use – just add water
- Vertical and overhead concrete repair; sprayable
- Non-toxic / no VOCs
- NSF 61 certified
- CE certified meeting EN 1504-3

Packaging

Megamix II is available in 55 lb. (25 kg) bags or in customized packaging to meet your specific requirements.

Storage

Xypex products must be stored dry at a minimum temperature of 45°F (7°C). Shelf life is one year.

Coverage

At 1/2 in. (12.5 mm) thickness, each 55 lb. (25 kg) bag of Megamix II will cover 11.3 sq. ft. (1.05 m²).

Laboratory Test Data

Compressive Strength (ASTM C 109) ¹		
@ 24 hrs	2600 psi	18 MPa
@ 3 days	4600 psi	32 MPa
@ 7 days	6100 psi	42 MPa
@ 28 days	7700 psi	53 MPa
Flexural Strength (ASTM C 78)		
@ 28 days	1190 psi	8.2 MPa
Splitting Tensile Strength (ASTM C 496)		
@ 28 days	603 psi	4.2 MPa
Direct Tensile Bond Strength to Concrete (ASTM C 1583)		
@ 90 days	330 psi	2.3 MPa
Elastic Modulus (EN 13412)		
28 days	20.4 GPa	
Rapid Chloride Permeability (ASTM C 1202)		
@ 28 days	< 572 coulombs	
@ 90 days	< 420 coulombs	
Carbonation Depth (EN 13295)		
@ age 49 days for 56 days in 1% CO ₂	no measurable carbonation depth	
Scaling Resistance (ASTM C 672)		
50 cycles	no scaling	
Chemical Resistance (ASTM C 267)		
mass loss (84 days)	negligible (retained 99.8% mass)	
Setting Time (ASTM C 266)		
initial	3:25 hrs:min	
final	5:00 hrs:min	
Note: Testing completed @ 14% water content of the mass of the dry ingredients @ 6% air content.		
¹ Results may differ based on statistical variability and site conditions. Recommended minimum specified strength for field conditions are: Compressive Strength: > 6,500 psi (45 MPa) and Bond Strength: > 130 psi (0.9 MPa).		

Application Procedures

1. SURFACE PREPARATION Remove loose, delaminated or unsound concrete by high pressure water blast, chipping, or other means. Complete structural or reinforcing steel corrosion repairs as necessary. Saw cut perimeter of repair area to a minimum depth of 3/8" (10

mm) - 3/4" (19 mm) preferred. Remove dust, micro fractured particles and foreign material from the repair area by pressure washing or other suitable means necessary to clean surface to obtain desired bond. A roughened surface texture such as ICRI CSP 5 or greater is typically required to achieve adequate bond. Maintain surface in saturated surface dry (SSD) condition for application of Megamix II mortar.

2. MIXING PROCEDURES Best results are achieved using a mechanical mortar mixer and paddle with a capacity for low speed continuous blending. For small quantities of material a paddle mixer can be substituted. Mix typically requires 0.91 to 0.94 U.S. gallons of water per 55 lb bag or (3.45 to 3.55 litres per 25 kg bag). Use only sufficient clean water to create a medium to stiff mortar consistency. Add approximately 90% of the required amount of water to a mixer and then add the Megamix II powder. Mix briefly and add additional water to achieve the required consistency (do not exceed maximum water without consulting a Xypex Technical Services Representative). Mix 3 - 5 minutes to achieve a uniform consistency. Over mixing or delivery delays may result in product stiffening. Do not over water.

3. APPLYING MEGAMIX II Spray the repair area with clean water and allow the surface to come to a saturated, surface dry (SSD) condition. Maintain concrete substrate in this condition during the application process. For improved bond, apply scrub coat of Megamix II onto prepared surface using a stiff bristle brush. Apply full coat of Megamix II while scrub coat is still wet (generally within 20 minutes). When applying Megamix II by low pressure spray equipment, use sufficient velocity to compact and build the thickness of the mortar. The spray nozzle should have a minimum 0.5 in. (12.5 mm) orifice to prevent clogging. Spray-apply Megamix II, at a right angle to surface, at a distance of 18 - 24 in. (450 - 600 mm). When applying Megamix II with a trowel ensure that the Megamix II is fully consolidated and worked well into the scrub coat and substrate. Complete finishing operations as quickly as possible. Megamix II can be finished to varying surface textures, including a rough finish directly from spraying nozzle, to semi-smooth using a wood or rubber float or smooth using a steel trowel.

Note:

i. For a recommendation regarding the specific type of equipment required for the mixing and for the spray application of Megamix II, contact the Technical Services Department of Xypex Chemical Corporation.

ii. For enhanced chemical protection and crack healing of the substrate Xypex Concentrate may be applied to broom finished surface of the Xypex Megamix II as soon as the surface will accept the Xypex Concentrate with-

out being disturbed. The Xypex Concentrate must then be mist cured for as long as required to ensure a 3 day wet cure of the Megamix II below it. Gamma Cure alone is not sufficient for curing a Concentrate on Megamix II installation.

iii. Xypex Xycrylic Admix at 2 parts water to 1 part Xycrylic dilution may be used as mix liquid in place of water for Megamix II.

iv. Megamix II can be extended with clean 3/8" (10 mm) coarse aggregate in specific applications. Consult a Xypex Technical Services Representative.

4. APPLICATION THICKNESS The thickness of the Megamix II application will depend on specific job site conditions and requirements. As a general guide, application thickness should be between 3/8 in. and 2 in. (10 mm and 50 mm). Single layer thickness for spray application will depend on equipment and applicator skill, but may be up to 2 in. (50 mm) vertical and 1.5 in. (40 mm) overhead. Roughen or score the surface before applying successive layers and apply immediately following initial set.

Note:

i. For any application greater than 2 in. (50 mm) thickness contact the Technical Services Department of Xypex Chemical Corporation or your local Xypex Technical Services Representative.

ii. Prior to the installation, it is recommended that a test section be completed under anticipated ambient and project conditions to demonstrate acceptable bond.

5. CURING Curing is essential to achieve optimum quality and durability of the repair mortar. Cure Megamix II using moist curing methods. For moist curing, apply continuous source of moisture by spray, or utilize wet burlap and polyethylene sheet or other suitable means for a minimum of 3 days. Containment structures (i.e. reservoirs, tanks, etc.) can be filled with water following 3 days moist curing of the Megamix II coating. When using a 2:1 water to Xycrylic Admix blend as the mix liquid, wet curing should not be done except in extremely hot and dry conditions. In these conditions consult Xypex Technical Services.

Note:

i. In most cases early curing procedures will be required prior to final set. This typically involves use of fog spray, or suitable evaporation retarding compounds following finishing.

ii. Megamix II should not be mixed and placed at temperatures below 39°F (3°C) or above 86°F (30°C). Protect from rapid evaporation (hot and/or cold and windy conditions).

Technical Services

For more instructions, alternative application / curing methods, or information concerning the compatibility of the Xypex treatment with other products or technologies, contact the Technical Services Department of Xypex Chemical Corporation or your local Xypex Technical Services Representative.

Certification

Xypex Megamix II satisfies the requirements of EN 1504-3; Initial Type Testing (ITT) according to EN 1504-3 was certified by BSI as the Notifying Body.

Safe Handling Information

Xypex is alkaline. As a cementitious powder or mixture, Xypex may cause significant skin and eye irritation. Directions for treating these problems are clearly detailed on all Xypex pails and packaging. The Manufacturer also maintains comprehensive and up-to-date Safety Data Sheets on all its products. Each sheet contains health and safety information for the protection of workers and customers. The Manufacturer recommends you contact Xypex Chemical Corporation or your local Xypex Technical Services Representative to obtain copies of Safety Data Sheets prior to product storage or use.

Warranty

The Manufacturer warrants that the products manufactured by it shall be free from material defects and will be consistent with its normal high quality. Should any of the products be proven defective, the liability to the Manufacturer shall be limited to replacement of the product ex factory. The Manufacturer makes no warranty as to merchantability or fitness for a particular purpose and this warranty is in lieu of all other warranties expressed or implied. The user shall determine the suitability of the product for his intended use and assume all risks and liability in connection therewith.

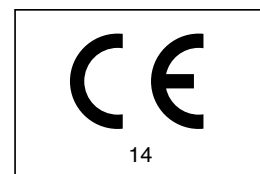

Description

XYPEX RESTORA-TOP 50 is one of three Xypex products specifically formulated for the repair and rehabilitation of horizontal concrete surfaces. Xypex Restora-Top 50 is used for the patching or resurfacing of deteriorated concrete up to 1/2 in. (12 mm) thick. It is used on surfaces where light traffic conditions exist. Xypex Restora-Top 50 consists of specially modified Portland cement, aggregates, admixtures and bonding agents combined in controlled proportions to provide excellent adhesion properties as well as reduced shrinkage.

Recommended for:

- Concrete Floors
- Driveways
- Decks
- Patios
- Steps
- Walkways
- Curbs
- Rain Damaged Slabs
- Levelling Course for Thin Set Mortars

Advantages

- Excellent adhesion to existing concrete surfaces
- Easy to use – just add water and mix
- Approximately 30 minutes working time
- Contains an integral bonding agent
- Moist curing is not normally required
- Ready for foot traffic in about 2.5 hours
- Suitable for indoor and outdoor use
- VOC compliant

Limitations

Restora-Top 50 should not be mixed and placed at temperatures below 50°F (10°C) or above 80°F (27°C). Protection from direct sunlight is desirable under hot or windy conditions. Restora-Top 50 contains a polymer additive to enhance bond. To achieve maximum bond strength, the polymer must be allowed to dry out after the initial setting and curing period. Avoid immersion prior to full curing of Restora-Top 50.

Packaging

Xypex Restora-Top 50 is available in 55 lb. (25 kg) pails.

Storage

Xypex products must be stored dry at a minimum temperature of 45°F (7°C).

Coverage

At 1/4 in. (6.4 mm) thickness, each 55 lb. (25 kg) pail of Restora-Top 50 will cover 24.8 sq. ft. (2.4 m²). For brush or broom applications, the yield will vary with the thickness and texture required. Each 55 lb. (25 kg) pail will cover an area of approximately 105 - 115 sq. ft. (10 - 11 m²) for a brush or broom application.

Physical Properties

Water Requirement		
0.936 U.S. gallons (3.6 litres) per 55 lb. (25 kg) pail		
Flow, ASTM C 230		
		115% - 125%
Working Time at 68°F (20°C)		
		30 - 40 minutes
Compressive Strength, CAN3 - A23.2 - 1B		
@ 1 day	2460 psi	17 MPa
@ 7 days	4930 psi	34 MPa
@ 28 days	5510 psi	38 MPa
Tensile Bond Strength to Concrete		
@ 7 days	116 psi	0.8 MPa
@ 28 days	200 psi	1.4 MPa

Note: Bond strength was determined by direct tensile loading of Restora-Top 50 which had been applied by trowel to a fully cured concrete slab at an average thickness of 1/2 in. (12 mm).

Application Procedures

1. Remove all laitance, dirt, films, paint, coatings and other foreign matter.
2. Saturate concrete with clean water. Remove any excess surface water and allow surface to partially dry.
3. Place dry powder in a clean mixing container and add water to reach the desired consistency. For trowel application, add 0.936 U.S. gallons (3.6 litres) of potable water per each 55 lb. (25 kg) pail of powder. For brush or broom applications add extra water (approximately 1.5 pints/700 ml) per 55 lb. (25 kg) pail of powder. Do not mix more Restora-Top 50 than can be applied in 30 minutes.
4. When trowel applying (max. 1/2 in./12 mm thick), work a thin layer into the surface as a primer coat, then build up to the desired thickness and trowel to the desired finish. Avoid over-trowelling. If the thickness is greater than 1/2 in. (12 mm), apply in 1/2 in. (12 mm) layers allowing each layer to cure overnight.

5. When broom applying, first work Restora-Top 50 into the surface with a stiff bristle broom before lightly brooming to obtain an even surface texture.

Curing

Because of the bonding and water retaining agents included in the mix, Restora-Top 50 does not normally require moist curing or protection. However, when applied in hot or windy conditions, Restora-Top 50 may require protection from rapid moisture loss by lightly spraying with water as necessary or by covering with a sheet of plastic.

Technical Services

For more instructions, alternative application methods, or information concerning the compatibility of the Xypex treatment with other products or technologies, contact the Technical Services Department of Xypex Chemical Corporation or your local Xypex Technical Services Representative.

Safe Handling Information

Xypex is alkaline. As a cementitious powder or mixture, Xypex may cause significant skin and eye irritation. Directions for treating these problems are clearly detailed on all Xypex pails and packaging. The Manufacturer also maintains comprehensive and up-to-date Safety Data Sheets on all its products. Each sheet contains health and safety information for the protection of workers and customers. The Manufacturer recommends you contact Xypex Chemical Corporation or your local Xypex Technical Services Representative to obtain copies of Safety Data Sheets prior to product storage or use.

Warranty

The Manufacturer warrants that the products manufactured by it shall be free from material defects and will be consistent with its normal high quality. Should any of the products be proven defective, the liability to the Manufacturer shall be limited to replacement of the product ex factory. The Manufacturer makes no warranty as to merchantability or fitness for a particular purpose and this warranty is in lieu of all other warranties expressed or implied. The user shall determine the suitability of the product for his intended use and assume all risks and liability in connection therewith.

Description

XYPEX RESTORA-TOP 100 is one of three Xypex products specifically formulated for the repair and rehabilitation of cast-in-place or precast concrete surfaces. Xypex Restora-Top 100 is used for patches up to 1 in. (25 mm) thick where rapid setting and strength gain are required. Restora-Top 100 consists of specially modified Portland cement, aggregates, polypropylene fibers, and admixtures combined in controlled proportions. This compound provides excellent adhesion properties, rapid setting and strength gain as well as superior durability and reduced shrinkage.

Recommended for:

- Concrete Floors
- Parking Decks
- Walkways
- Warehouse Floors
- Bridge Decks
- Roads

Advantages

- Excellent adhesion to existing concrete surfaces
- Traffic-ready in two to four hours
- Easy to use – just add water and mix
- Rapid set and strength gain
- Suitable for indoor and outdoor use
- VOC compliant

Limitations

Restora-Top 100 should not be mixed and placed at temperatures below 37°F (3°C) or above 86°F (30°C). Protection from direct sunlight is desirable under hot or windy conditions. Use only as a patching or filling material.

Packaging

Xypex Restora-Top 100 is available in 55 lb. (25 kg) pails.

Storage

Xypex products must be stored dry at a minimum temperature of 45°F (7°C).

Coverage

At 1 in. (25 mm) thickness, each 55 lb. (25 kg) pail of Restora-Top 100 will cover approximately 5.7 sq. ft. (0.52 m²) or yield approximately 0.43 ft.³ (12.1 litres) of repair materials.

Physical Properties

Setting Time, ASTM C 403		
Initial, at 68°F (20°C)	25 minutes	
Final, at 68°F (20°C)	45 minutes	
Working Time at 68°F (20°C)		
	20 minutes	
Air Content (% of Volume)		
	5%	
Compressive Strength		
@ 1 hr. after initial set	2150 psi	14.8 MPa
@ 3 hrs. after mixing	3000 psi	20.7 MPa
@ 6 hrs.	3450 psi	23.8 MPa
@ 24 hrs.	5000 psi	34.5 MPa
@ 28 days	7500 psi	51.7 MPa
Scaling Resistance in Presence of De-Icing Salt, ASTM C672 After 50 Cycles of Freezing and Thawing		
No Scaling (Rating O)		

Note:

- The typical properties noted above are based on mixing the Restora-Top 100 with sufficient water to provide a slump of 3.5 to 4 in. (90 - 100 mm). These properties are based on mixing and curing the product at 70°F (21°C).
- Compressive strength determined on 2 in. (50 mm) cube specimens, moist cured at 73° ± 3°F (23° ± 2°C) after 24 hours.

Application Procedures

- Remove loose or unsound concrete by chipping, saw cutting, or other mechanical means. It is preferable to have a minimum repair thickness of 1/2 in. (12 mm) with square cut edges. Feather edging is not recommended.
- Remove dust and foreign material from the repair area.
- Saturate the repair area with water. Just as the concrete surface becomes dry, place the Restora-Top 100 material.
- Add approximately 3/4 of the required water to the mixing container (0.39 U.S. gallons / 1.5 litres of water is usually sufficient at this stage for each 55 lb. / 25 kg pail of product). While mixing, gradually add the Restora-Top 100 powder to the water. Add more water as required to obtain the desired consistency. Do not exceed 0.86 U.S. gallons (3.3 litres) of water per 55 lb. (25 kg) pail of Restora-Top 100.

5. Mix until thoroughly blended and until required consistency has been obtained. Normally a 2 minute mixing time is adequate. If the Restora-Top begins to harden or set, discard the mix. Do not add more water to the mixing container.

6. Place the mixed material as rapidly as possible and work the mix well into the prepared concrete surface to ensure freedom from voids and to obtain proper bonding.

7. Complete finishing operations as quickly as possible and be sure to clean the mixing container between batches. Partially set material in the mixer can accelerate the setting of subsequent batches.

Note: During cold weather the use of hot water, and storage of Restora-Top 100 in a warm, dry place before use will prevent excessively long setting times.

Curing

1. After final set, moist curing of Restora-Top 100 for 24 hours is recommended.

2. In hot, dry or windy weather conditions, apply curing compound to the repaired area as soon as the Restora-Top material has set.

3. Protect from freezing for the first 24 hours, and protect from temperatures below 27°F (-3°C) for 72 hours.

Technical Services

For more instructions, alternative application methods, or information concerning the compatibility of the Xypex treatment with other products or technologies, contact the Technical Services Department of Xypex Chemical Corporation or your local Xypex Technical Services Representative.

Safe Handling Information

Xypex is alkaline. As a cementitious powder or mixture, Xypex may cause significant skin and eye irritation. Directions for treating these problems are clearly detailed on all Xypex pails and packaging. The Manufacturer also maintains comprehensive and up-to-date Safety Data Sheets on all its products. Each sheet contains health and safety information for the protection of workers and customers. The Manufacturer recommends you contact Xypex Chemical Corporation or your local Xypex Technical Services Representative to obtain copies of Safety Data Sheets prior to product storage or use.

Warranty

The Manufacturer warrants that the products manufactured by it shall be free from material defects and will be consistent with its normal high quality. Should any of the products be proven defective, the liability to the Manufacturer shall be limited to replacement of the product ex factory. The Manufacturer makes no warranty as to merchantability or fitness for a particular purpose and this warranty is in lieu of all other warranties expressed or implied. The user shall determine the suitability of the product for his intended use and assume all risks and liability in connection therewith.

Description

XYPEX RESTORA-TOP 200 is one of three Xypex products specifically formulated for the repair and rehabilitation of cast-in-place or precast concrete surfaces. Xypex Restora-Top 200 is recommended for patching requirements that exceed 1 in. (25 mm) thickness and where high impact resistance is required. Restora-Top 200 consists of specially modified Portland cement, fine aggregate gradations, 1.2 in. (30 mm) long steel fibers, and admixtures combined in controlled proportions. This compound provides excellent adhesion properties, rapid setting and strength gain as well as superior durability and reduced shrinkage.

Recommended for:

- Concrete Floors
- Parking Decks
- Walkways
- Warehouse Floors
- Bridge Decks
- Roads

Advantages

- Excellent adhesion to existing concrete surfaces
- Traffic-ready in two to four hours
- Increased toughness and impact resistance
- Easy to use – just add water and mix
- Rapid set and strength gain
- Suitable for indoor and outdoor use
- VOC compliant

Limitations

Restora-Top 200 should not be mixed and placed at temperatures below 37°F (3°C) or above 86°F (30°C). Protection from direct sunlight is desirable under hot or windy conditions. Use only as a patching or filling material.

Packaging

Xypex Restora-Top 200 is available in 55 lb. (25 kg) pails.

Storage

Xypex products must be stored dry at a minimum temperature of 45°F (7°C).

Coverage

At 1 in. (25 mm) thickness, each 55 lb. (25 kg) pail of Restora-Top 200 will cover approximately 5.7 sq. ft. (0.52 m²) or yield approximately 0.43 ft.³ (12.1 litres) of repair materials.

Physical Properties

Setting Time, ASTM C 403		
Initial, at 68°F (20°C)	25 minutes	
Final, at 68°F (20°C)	45 minutes	
Working Time at 68°F (20°C)		
	20 minutes	
Air Content (% of Volume)		
	5%	
Compressive Strength		
@ 1 hr. after initial set	2150 psi	14.8 MPa
@ 3 hrs. after mixing	3000 psi	20.7 MPa
@ 6 hrs.	3450 psi	23.8 MPa
@ 24 hrs.	5000 psi	34.5 MPa
@ 28 days	7500 psi	51.7 MPa
Scaling Resistance in Presence of De-Icing Salt, ASTM C672 After 50 Cycles of Freezing and Thawing		
No Scaling (Rating O)		

Note:

- The typical properties noted above are based on mixing the Restora-Top 100 with sufficient water to provide a slump of 3.5 to 4 in. (90 - 100 mm). These properties are based on mixing and curing the product at 70°F (21°C).
- Compressive strength determined on 4 in. (100 mm) cube specimens, moist cured at 73° ± 3°F (23° ± 2°C) after 24 hours.

Application Procedures

- Remove loose or unsound concrete by chipping, saw cutting, or other mechanical means. It is preferable to have a minimum repair thickness of 1/2 in. (12 mm) with square cut edges. Feather edging is not recommended.
- Remove dust and foreign material from the repair area.
- Saturate the repair area with water. Just as the concrete surface becomes dry, place the Restora-Top 200 material.
- Add approximately 3/4 of the required water to the mixing container (0.39 U.S. gallons / 1.5 litres of water is usually sufficient at this stage for each 55 lb. / 25 kg pail of product). While mixing, gradually add the Restora-Top 200 powder to the water. Add more water as required to obtain the desired consistency. Do not exceed 0.8 U.S. gallons (3 litres) of water per 55 lb. (25 kg) pail of Restora-Top 200.

5. Mix until thoroughly blended and until required consistency has been obtained. Normally a 2 minute mixing time is adequate. If the Restora-Top begins to harden or set, discard the mix. Do not add more water to the mixing container.

6. Place the mixed material as rapidly as possible and work the mix well into the prepared concrete surface to ensure freedom from voids and to obtain proper bonding.

7. Complete finishing operations as quickly as possible and be sure to clean the mixing container between batches. Partially set material in the mixer can accelerate the setting of subsequent batches.

Note: During cold weather the use of hot water, and storage of Restora-Top 200 in a warm, dry place before use will prevent excessively long setting times.

Curing

1. After final set, moist curing of Restora-Top 200 for 24 hours is recommended.

2. In hot, dry or windy weather conditions, apply curing compound to the repaired area as soon as the Restora-Top material has set.

3. Protect from freezing for the first 24 hours, and protect from temperatures below 27°F (-3°C) for 72 hours.

Technical Services

For more instructions, alternative application methods, or information concerning the compatibility of the Xypex treatment with other products or technologies, contact the Technical Services Department of Xypex Chemical Corporation or your local Xypex Technical Services Representative.

Safe Handling Information

Xypex is alkaline. As a cementitious powder or mixture, Xypex may cause significant skin and eye irritation. Directions for treating these problems are clearly detailed on all Xypex pails and packaging. The Manufacturer also maintains comprehensive and up-to-date Safety Data Sheets on all its products. Each sheet contains health and safety information for the protection of workers and customers. The Manufacturer recommends you contact Xypex Chemical Corporation or your local Xypex Technical Services Representative to obtain copies of Safety Data Sheets prior to product storage or use.

Warranty

The Manufacturer warrants that the products manufactured by it shall be free from material defects and will be consistent with its normal high quality. Should any of the products be proven defective, the liability to the Manufacturer shall be limited to replacement of the product ex factory. The Manufacturer makes no warranty as to merchantability or fitness for a particular purpose and this warranty is in lieu of all other warranties expressed or implied. The user shall determine the suitability of the product for his intended use and assume all risks and liability in connection therewith.

Description

Xypex FCM 80 is specifically designed for repairing cracks subject to movement, sealing construction joints, restoring deteriorated concrete, and waterproofing concrete structures. FCM 80 has exceptional adhesive and elongation characteristics and is often used in conjunction with the Xypex Crystalline Concrete Waterproofing and Protection System. FCM is a two component product consisting of a specialized liquid polymer dispersion and a cementitious powder. These components are mixed just prior to application.

Recommended for:

- Moving Cracks
- Construction Joints
- Deteriorated Concrete Surfaces
- Concrete Block Walls
- Balconies, Terraces, and Planters
- Water-holding Structures
- Sewage and Water Treatment Tanks
- Marine Structures
- Thermal Contraction and Expansion

Advantages

- Flexible
- Superior elongation properties
- Excellent adhesive qualities
- Impermeable to water and chlorides
- Breathable, seamless
- Durable, retains properties in climatic extremes
- Non-toxic, solvent-free, odorless
- Effective when subjected to thermal contraction and expansion

Packaging

The Xypex FCM 80 is packaged in a carton as a unit (kit), which includes the liquid component (1.06 U.S. gallon / 4 litre bottle) and the powder component (22 lb. / 10 kg pail). For larger projects, customized packaging is available; contact the manufacturer for details.

Coverage

When mixed, one unit will cover an estimated 28 sq. ft. (2.6 m²) at a two-coat application thickness of 1/8 in. (3 mm).

Storage

FCM materials must be stored dry at a minimum temperature of 45°F (7°C). Shelf life is six months when stored under proper conditions.

Properties

Solids Content (liquid component – EN ISO 3251)	
Solids Content (%)	54
Viscosity (liquid component – EN ISO 3219)	
Dynamic Viscosity (MPa)	50 - 155
Glass Transition Temperature (liquid component)	
T _g	-49°C
Liquid Water Permeability (EN 1062-1 Table 5)	
Water Transmissibility	Class W ₃ – Low (<0.1 kg / (m ² ·hr ^{0.5}))
Tensile Properties (ASTM D 412) – 28 day old; lab cured	
Elongation @ Break (%)	60 - 100%
Tensile Strength (MPa / psi)	1.0 / 145
Bond Strength (EN 1542) – 28 day old; lab cured	
Bond Strength (MPa / psi)	0.80 / 116
Cold Bend Test (in house procedure)	
Resistance to Cracking (using 9.5 mm mandrel @ -16°C)	pass (no crack)

Application Procedures

SURFACE PREPARATION

Concrete surfaces must be free of all bond inhibiting materials such as loose concrete, dirt, dust, oil, grease, release agents, curing and cleaning compounds. Clean the surface thoroughly by sandblasting, waterblasting or etching with muriatic (HCL) acid. Prior to the FCM application, the preferred substrate moisture condition is dry, but may be “saturated surface dry”.

MIXING

Mix by weight: 1 part FCM 80 liquid with 2.5 parts FCM powder. Mix thoroughly for 3 to 4 minutes to obtain a homogeneous and lump-free compound. Do not mix more material than can be used in 30 minutes.

REPAIR OF HAIRLINE CRACKS AND FAULTY CONSTRUCTION JOINTS – NEGATIVE SIDE APPLICATION

No Water Flow

1. Clean and prepare the concrete surface as specified above.
2. Sawcut a 1 in. (25 mm) groove along crack length to a depth of approximately 1.5 in. (40 mm). Avoid contact with reinforcing steel.

3. Pressure wash cracks to remove loose material.
4. Mix 3 parts Xypex Concentrate and 1 part Patch'n Plug with 1 part water by volume to a stiff mortar consistency and pack tightly into groove. Air cure minimum of 40 minutes.
5. Trowel-apply first coat of FCM 80 to a width of 4 - 6 in. (10 - 15 cm) and a thickness of 1/16 in. (1.5 mm). Allow first coat to dry for six hours, then apply second coat of FCM 80 at the same rate to a total membrane thickness of 1/8 in. (3 mm). The second coat should be applied at right angles to the first coat.

Against a Flow of Water

1. Follow the same preparation procedures as above (i.e. cleaning, saw cutting, power washing).
2. Mix 3 parts Xypex Patch'n Plug and 1 part Concentrate with 1 part water by volume (note: this is the reverse of the ratio above) to a stiff mortar consistency and pack tightly into groove. Air cure minimum 40 minutes.
3. Trowel-apply first coat of FCM 80 to a width of 4 - 6 in. (10 - 15 cm) and a thickness of 1/16 in. (1.5 mm). Allow first coat to dry for six hours, then apply second coat of FCM 80 at the same rate to a total membrane thickness of 1/8 in. (3 mm). The second coat should be applied at right angles to the first coat.

COATING APPLICATION – POSITIVE SIDE

1. Clean and prepare the concrete substrate as specified above.
2. Apply an initial coat of the FCM 80 mixture by trowel or spray to a thickness of approximately 1/16 in. (1.5 mm). Allow coating to dry for minimum of six hours and maximum of 24 hours.
3. Apply second coat at right angles to first coat to ensure even coverage. Second coat should bring total membrane thickness to 1/8 in. (3 mm).

Note:

- i. For optimum performance, the FCM coating should be applied to the positive side of a concrete surface subjected to hydrostatic pressure.
- ii. The ambient temperature for applying FCM should be between 50°F (10°C) and 86°F (30°C).
- iii. FCM can be applied directly over cracks up to 1/16 in. (1.5 mm) width and the FCM will withstand crack movement up to 1/16 in. (1.5 mm).

iv. If significant crack movement is anticipated, a “bond-breaker” is recommended. Simply place 3/4 in. (19.1 mm) wide Scotch Linerless Rubber Splicing Tape 130C over the top of the crack or joint prior to applying the FCM membrane. This will allow for further elongation of the FCM material.

v. Overall waterproofing system details such as penetrations, perimeters, upturns, drainage, protection systems, etc. are the responsibility of the designer and / or users.

Curing

Xypex FCM 80 does not require any special curing procedures other than maintaining coating above 50°F (10°C) for a period of 24 hours after application. The FCM dries within 5 to 6 hours of application at 68°F (20°C). Protect the membrane surface from rain or water until dry. Air cure minimum 14 days prior to immersing the membrane in water.

Technical Services

For more instructions, alternative installation methods, or information concerning the compatibility of the Xypex treatment with other products or technologies, contact the Technical Services Department of Xypex Chemical Corporation or your local Xypex Technical Services Representative.

Safe Handling Information

In liquid, powder or mixed form, FCM 80 may cause significant skin and eye irritation. Directions for treating these problems are clearly detailed on all Xypex pails and packaging. The Manufacturer also maintains comprehensive and up-to-date Safety Data Sheets on all its products. Each sheet contains health and safety information for the protection of workers and customers. Contact the Manufacturer or your local Xypex Technical Services Representative to obtain copies of Safety Data Sheets prior to product storage or use.

Warranty

The Manufacturer warrants that the products manufactured by it shall be free from material defects and will be consistent with its normal high quality. Should any of the products be proven defective, the liability to the Manufacturer shall be limited to replacement of the product ex factory. The Manufacturer makes no warranty as to merchantability or fitness for a particular purpose and this warranty is in lieu of all other warranties expressed or implied. The user shall determine the suitability of the product for his intended use and assume all risks and liability in connection therewith.

Description

XYPEX GAMMA CURE is a curing agent designed specifically for Xypex crystalline waterproofing products. Gamma Cure may be used as an alternative to water curing for certain Xypex applications. It is also used to accelerate the Xypex crystallization process. Xypex Gamma Cure acts as an evaporation retardant by retaining the maximum amount of moisture in the Xypex coating. It also provides a catalyst for the reaction with the Xypex crystalline waterproofing treatment. It is a self-dissipating (2 - 3 days) non-film forming product.

Recommended for:

- Applications where water-curing is not possible
- Hot, dry, windy conditions
- Vertical surfaces

Packaging

Xypex Gamma Cure is available in 1 U.S. gallon (3.79 litre) bottles and 5 U.S. gallon (18.95 litre) pails.

Storage

Xypex products must be stored dry at a minimum temperature of 45°F (7°C). Shelf life is one year when stored under proper conditions.

Coverage

One U.S. gallon (3.79 litres) of Gamma Cure when diluted with water will cover approximately 800 sq. ft. (75 m²).

Application Procedures

1. CURING OF XYPEX COATING Dilute one part Gamma Cure with 3 parts clean water. Apply by spraying onto the crystalline waterproofing coating after the coating has reached an initial set, but before it dries (approx. 1 - 2 hours).

2. PREPARATION OF CONCRETE SUBSTRATE IN HOT, DRY OR WINDY CONDITIONS Dilute one part Gamma Cure with 3 parts clean water and apply to concrete surface before application of the Xypex crystalline coating. Gamma Cure should be applied while the concrete is still damp from pre-watering.

Technical Services

For more instructions, alternative installation methods, or information concerning the compatibility of the Xypex treatment with other products or technologies, contact the Technical Services Department of Xypex Chemical Corporation or your local Xypex Technical Services Representative.

Safe Handling Information

Gamma Cure is an acidic solution. This product may be a mild to moderate skin and eye irritant. In addition, many of the components of the cementitious products that are used in conjunction with the Gamma Cure may also possess significant skin and eye irritation potential. Directions for treating these problems are clearly detailed on all Xypex pails and packaging. The Manufacturer also maintains comprehensive and up-to-date Safety Data Sheets on all its products. Each sheet contains health and safety information for the protection of workers and customers. The Manufacturer recommends you contact Xypex Chemical Corporation or your local Xypex Technical Services Representative to obtain copies of Safety Data Sheets prior to product storage or use.

Warranty

The Manufacturer warrants that the products manufactured by it shall be free from material defects and will be consistent with its normal high quality. Should any of the products be proven defective, the liability to the Manufacturer shall be limited to replacement of the product ex factory. The Manufacturer makes no warranty as to merchantability or fitness for a particular purpose and this warranty is in lieu of all other warranties expressed or implied. The user shall determine the suitability of the product for his intended use and assume all risks and liability in connection therewith.

Description

XYCRYLIC ADMIX is a water-based, high solids, polymer dispersion specifically designed for fortifying Portland cement compositions. This liquid is milky-white in color and improves curing qualities, enhances bond, imparts excellent water and weather resistance, and reduces shrinkage cracking. Xycrylic Admix is also used to fortify Xypex Patch'n Plug and Megamix I.

Recommended for:

- Patching and Concrete Repairs
- Resurfacing Floor Underlayments
- Terrazzo Flooring
- Spray and Fill Coats
- Highway and Bridge Deck Repair

Advantages

- Hardens and toughens cement mortars for improved durability
- Enhances adhesion capabilities to a wide variety of surfaces
- Increases resistance to many industrial chemicals
- Eliminates water curing
- NSF 61 certified when used with Megamix I

Durability and Strength

Cement mortars modified with Xycrylic Admix are hard, tough and durable. Compared with unmodified mortars, Xycrylic modified mortars have far superior flexural, adhesive and impact strengths as well as excellent abrasion resistance. They are especially useful where thin sections are desirable and where excessive vibration and heavy traffic is encountered.

Adhesion

Xycrylic Admix modified mortars have excellent adhesion to a variety of surfaces such as concrete, masonry, brick, wood, metals and others.

Resistance Properties

Cement mortars modified with Xycrylic Admix are resistant to many industrial chemicals as well as ultraviolet light and heat. Mortars containing Xycrylic Admix dry to a uniform color.

Packaging

Xycrylic Admix is available in 1 U.S. gallon (3.79 litre) bottles and 5 U.S. gallon (18.95 litre) pails.

Storage

Keep Xycrylic Admix from freezing.

Mixing

Xycrylic Admix may be used full strength or diluted with clean water depending on application requirements.

Test Data

Physical Strength of Cement Mortars					
ASTM Standard Test Method	Mixing Liquid				
	Full Strength	1:1 Water	1:2 Water	No Xycrylic	
C-190-85 Tensile Strength	610 4.2	440 3.0	375 2.6	235 1.6	psi MPa
C-109-88 Compressive Strength	5700 39.3	4530 31.2	3830 26.4	2390 16.5	psi MPa
C-348-86 Flexural Strength	1570 10.8	1130 7.8	960 6.6	610 4.2	psi MPa
Shear Bond Adhesion	640 4.4	360 2.5	260 1.8	45 0.31	psi MPa

Note 1: Strength properties are based on cement mortar prepared as 3 parts sand to 1 part cement by volume.

Note 2: Strengths are based on a 28 day air-cure. Wet cure strengths may be less.

Application Procedures

Xycrylic Admix may be used full strength or diluted with clean water depending on application requirements.

For Use With Cement Mortar

1. Thoroughly premix sand and cement (1 part cement to 2 parts sand).
2. Blend Xycrylic Admix with water according to strength, bonding and resistance requirements.
3. Add the Xycrylic mixing liquid (whether full strength or diluted with water) to the sand and cement.
4. Mix thoroughly until desired workable consistency is reached. Always withhold some Xycrylic mixing liquid so that the mortar will not be too fluid and so that mixing liquid can be carefully gauged near end of mixing cycle (2 - 4 minutes).

For Use With Patch'n Plug

1. Blend Xycrylic Admix with clean water (1 part Xycrylic to 1 part water by volume).

2. Add Xycrylic mixing liquid to the Patch'n Plug powder at a rate of 1 part liquid to 3.5 parts Patch'n Plug.

3. Mix to a stiff putty consistency. Do not mix more than can be used in three minutes.

For Use With Megamix I

1. Prepare the mixing liquid by combining 1 part Xycrylic Admix with 2 parts clean water.

2. Mix 1.4 - 1.5 U.S. gallons (5.4 - 5.7 litres) of the mixing liquid with one 60 lb. (27.2 kg) pail of Megamix I powder.

3. Mix thoroughly to a creamy consistency. Let mixture stand for 3 - 5 minutes, re-agitate and then apply.

Curing

For optimum physical properties, cement mortars modified with Xycrylic Admix should be air-cured at ambient temperature and relative humidity.

Technical Services

For more instructions, alternative installation methods, or information concerning the compatibility of the Xypex treatment with other products or technologies, contact the Technical Services Department of Xypex Chemical Corporation or your local Xypex Technical Services Representative.

Certification

Xypex Xycrylic Admix when used with Megamix I satisfies the requirements of EN 1504-3; Initial Type Testing (ITT) according to EN 1504-3 was certified by BSI as the Notifying Body.

Safe Handling Information

Xycrylic Admix is alkaline and has a slight ammoniacal odor. This product may be a mild to moderate skin and eye irritant. In addition, many of the components of the cementitious products that are used in conjunction with the Xycrylic Admix may also possess significant skin and eye irritation potential. Directions for treating these problems are clearly detailed on all Xypex pails and packaging. The Manufacturer also maintains comprehensive and up-to-date Safety Data Sheets on all its products. Each sheet contains health and safety information for the protection of workers and customers. The Manufacturer recommends you contact Xypex Chemical Corporation or your local Xypex Technical Services Representative to obtain copies of Safety Data Sheets prior to product storage or use.

Warranty

The Manufacturer warrants that the products manufactured by it shall be free from material defects and will be consistent with its normal high quality. Should any of the products be proven defective, the liability to the Manufacturer shall be limited to replacement of the product ex factory. The Manufacturer makes no warranty as to merchantability or fitness for a particular purpose and this warranty is in lieu of all other warranties expressed or implied. The user shall determine the suitability of the product for his intended use and assume all risks and liability in connection therewith.

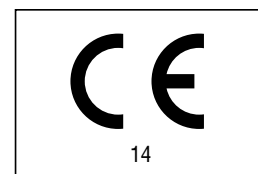

Description

Xypex Quickset is a water-soluble liquid blend of silicates, neutralizers and penetrating agents specially compounded to harden, dustproof and seal the surface of concrete. Applied to the concrete surface, Xypex Quickset penetrates into the capillaries of the concrete substrate and chemically reacts with the free lime and calcium carbonate to form a hard, insoluble gel within the pores, thus closing off the small voids. Quickset provides superior hardening and a dustproof finish.

Recommended for:

- Concrete slabs where a hard, abrasion resistant (light to moderate traffic load), dustproof surface is required.
- Enhancing the abrasion resistance of a concrete surface where Concentrate DS-1 or DS-2 has been applied.

Packaging

Xypex Quickset is available in 1 U.S. gallon (3.79 litre) bottles and 5 U.S. gallon (18.95 litre) pails.

Storage

Xypex products must be stored dry at a minimum temperature of 45°F (7°C). Shelf life is one year when stored under proper conditions.

Coverage

Coverage rates will vary depending on surface conditions of the concrete, porosity, and project requirements. The following rates are approximate, assuming average concrete, finish, temperature and other factors:

Rough or Broom Finish	100 - 120 ft. ² /U.S. gallon (2.5 - 3.0 m ² /litre)
Moderately Trowelled Floor	120 - 150 ft. ² /U.S. gallon (3.0 - 3.8 m ² /litre)
Heavily Trowelled Floor	150 - 200 ft. ² /U.S. gallon (3.8 - 5.0 m ² /litre)

For the best results, increase coverage rate for each succeeding coat.

Application Procedures

1. Surface to be treated should be clean and free of all loose dirt, oil, curing compounds, efflorescence, free standing water and other foreign material. New concrete should have cured at least one month before treatment.

2. Dilute Quickset at a rate of one part liquid Quickset solution to one part clean water by volume. Mix thoroughly.

3. Apply Xypex Quickset by brush, soft-bristle broom, squeegee or spray. When applying by squeegee, the Quickset should be spread evenly over the surface to eliminate all puddles, or excess liquid. Brush out or mop up any puddles immediately.

4. If Xypex Quickset is to be spray applied, a garden-type sprayer can be used and the liquid should be applied in an even and uniform manner so that there are no puddles. It is recommended that the application be done in two even coats and each coat must be allowed to dry thoroughly before proceeding with next coat. Any surplus Quickset liquid should be immediately mopped up or brushed out.

Note:

1. Xypex Quickset should not be applied in temperatures less than 45°F (7°C) and must be kept from freezing before use.

2. Protect glass, stainless steel, aluminum, painted and ceramic surfaces from Xypex Quickset. If this should occur immediately wipe off with cloth soaked in water and wipe dry.

Drying Time

Xypex Quickset dries in approximately one-half to one hour per coat depending on temperature, humidity, project conditions, etc. Each coat should be allowed to dry thoroughly before applying additional coats. Xypex Quickset should be completely dry before any traffic is permitted. It is recommended that 24 hours elapse before permitting any traffic on the treated area.

Technical Services

For more instructions, alternative installation methods, or information concerning the compatibility of the Xypex treatment with other products or technologies, contact the Technical Services Department of Xypex Chemical Corporation or your local Xypex Technical Services Representative.

Safe Handling Information

Xypex Quickset is a highly alkaline solution. This product may be a mild to moderate skin and eye irritant. In addition, many of the components of the cementitious products that are used in conjunction with the Xypex Quickset may also possess significant skin and eye irritation potential. Directions for treating these problems are clearly detailed on all Xypex pails and packaging. The

Manufacturer maintains comprehensive and up-to-date Safety Data Sheets on all its products. Each sheet contains health and safety information for the protection of workers and customers. The Manufacturer recommends that you contact Xypex Chemical Corporation or your local Xypex Technical Services Representative to obtain copies of Safety Data Sheets prior to product storage or use.

Warranty

The Manufacturer warrants that the products manufactured by it shall be free from material defects and will be consistent with its normal high quality. Should any of the products be proven defective, the liability to the Manufacturer shall be limited to replacement of the product ex factory. The Manufacturer makes no warranty as to merchantability or fitness for a particular purpose and this warranty is in lieu of all other warranties expressed or implied. The user shall determine the suitability of the product for his intended use and assume all risks and liability in connection therewith.

Section	Page
Coating Application Details	
Concrete Coating Installation and Procedures	1
Waterproofing of CMU / Concrete Block Walls	4
Fast-Track Coating System	6
Waterproofing of Dry Mix Shotcrete / Existing Concrete Pools	7
Waterproofing of Stone and Brick Walls	9
New Construction Details	
Waterproofing Concrete Tie Holes Using Xypex	11
Xypex Waterproofing of Annular Spaces	16
Repair Details	
Repair of Cracks and Faulty Construction Joints	19
Repair of Slab Interface Joints	22
Repair of Defective Concrete, Rock Pockets or Honeycombs	25
Pipe Through Wall / Slab Repair Procedures	27
Repair of Leaking Tie Holes	30

CONCRETE COATING INSTALLATION AND PROCEDURES

General Information & Standard Xypex Coating Installation Procedures for Use on Concrete

The following are general directions on the installation and use of Xypex Concentrate and Modified coatings for Xypex modification of poured in place concrete elements. The information presented is in addition to Xypex product data sheets and is not meant to replace these or any other installation guides but rather is meant to give a general description of the installation practices, curing procedures and other information surrounding the use of Xypex products for waterproofing and protecting concrete and while they normally provide an acceptable final appearance they are not meant as aesthetic finishes.

Weather and Concrete Conditions

1. The Xypex treatment must not be applied under rainy conditions or when ambient temperature is below 40°F (4°C).
2. Because Xypex requires water as a diffusion medium and to initiate the crystalline waterproofing process, all concrete, whether fresh or old, must be in a saturated surface dry (SSD) condition prior to coating application. (See Wetting Concrete below.)
3. The concrete surface must be a minimum of 20 hours old before application of the Xypex coating treatment.
4. For fresh concrete, the period between 24 hours and 72 hours is the optimum time within which to apply Xypex, as the new concrete is still “green” and requires very little pre-watering.

Coverage

For normal surface conditions, the coverage rate for each Xypex coat is 1.25 - 1.5 lb./sq.yd. (0.65 - 0.8 kg/m²). Where a single heavy coat is to be used the coverage rate is 2.0 lb./sq.yd. (1.0 kg/m²).

Surface Preparation

1. The concrete surface to be treated must be clean and free of laitance, dirt, film, paint, coatings or other foreign matter. The surface must also have an open capillary system to provide “tooth and suction” for the Xypex treatment. A CSP-3 per the International Concrete Repair Institute Guidelines and Surface Profile Chips is recommended.
2. If surface is too smooth (e.g. where steel forms are used) or if surface is covered with excess form oil or other foreign matter, the concrete should be lightly sand-blasted, water-blasted, or etched with acid.
3. Horizontal surfaces should have a rough wood float or broom finish. Concrete laitance must be removed from surface by light sand-blasting, water-blasting or etching with acid.

4. Surfaces to be etched with acid should be dampened with water before application of the acid. After acid etching flush concrete thoroughly with clean water.

Repairs Prior to Coating Application

For cracks larger than 1/64” (0.4 mm) or for actively leaking cracks the following repair procedures are recommended.

1. Chip out cracks, faulty construction joints and other structural defects to a depth of 1.5” (37 mm) and a width of one inch (25 mm). A “V” shaped slot is not acceptable. The slot may be saw cut instead of chipped but ensure that the slot is dovetailed or otherwise shaped such that there will be mechanical interlock of materials placed into the slot at a later stage.
2. Clean slot, wet concrete and apply a brush coat of Xypex Concentrate (as described below) in cavity and allow to dry for 10 minutes.
3. Fill cavity by tightly compressing Dry-Pac into the groove with pneumatic packing tool or with hammer and wood block. (See below for Dry-Pac mixing instructions.)
4. Against a direct flow of water (leakage) or where there is excess moisture due to seepage, use Xypex Patch’n Plug in lieu of Dry-Pac followed by a brush coat of Xypex Concentrate. For expansion joints or chronic moving cracks, flexible materials such as expansion joint sealants should be used.

All areas of poor concrete consolidation (honeycomb or rock pockets) should also be repaired. Refer to Xypex Method Statements (Section 1.3, p. 4-31) or contact Xypex’s Technical Services Department or your local Xypex Technical Services Representative for more information.

Wetting Concrete

Xypex requires a saturated substrate and a dry surface. This is commonly referred to as a saturated surface dry or SSD condition. SSD concrete will not absorb any more water but has no glistening water on the surface. Concrete surfaces, therefore, must be thoroughly saturated

CONCRETE COATING INSTALLATION AND PROCEDURES

General Information & Standard Xypex Coating Installation Procedures for Use on Concrete

with clean water prior to the application so as to aid the proper diffusion of the Xypex chemistry and to ensure the growth of the crystalline formation deep within the pores of the concrete. Remove excess water before the application such that there is no glistening water on the surface. If concrete dries out before application, it must be re-wetted.

Mixing

1. Mix Xypex with clean water only (potable water that is free of salt and other deleterious materials).
2. Mix Xypex powder into the clean water with a paddle on a slow speed electric drill (250 RPM) or with other equipment that ensures adequate mixing. For small jobs, Xypex may be mixed by gloved hand or by trowel.
3. Be sure that the quantity mixed can be applied within 20 minutes. As the mixture thickens, stir briefly to refluidize the mix but do not add water.

Mixing For Slurry Coat

Mix Xypex powder with clean water to a creamy consistency in the following volume proportions:

For Brush Application

1.25 - 1.5 lb./sq.yd. (0.65 - 0.8 kg/m²)
5 parts powder to 2 parts water

2.0 lb./sq.yd. (1.0 kg/m²)

3 parts powder to 1 part water

For Spray Application

1.25 - 1.5 lb./sq.yd. (0.65 - 0.8 kg/m²)
5 parts powder to 3 parts water
(ratio may vary with equipment type)

Mixing Dry-Pac

Using a trowel, mix one part clean water with six parts Xypex Concentrate powder by volume for 10 - 15 seconds. Lumps should be present in this mixture. Do not mix more than can be applied in 20 minutes.

Applying Xypex

1. Apply Xypex with a semi-stiff nylon bristle brush, push broom (for large horizontal surfaces), or specialized spray equipment. Do not apply Xypex with a trowel, roller, paintbrush or paint sprayer. Contact Xypex's Technical Services Department or your local Xypex Technical Services Representative for further information.

2. The Xypex coating must be uniformly applied and should be just under 1/16" (1.25 mm) thick. A thicker coating can cause curing or other difficulties, especially in warm weather.

3. When a second coat (Xypex Concentrate or Modified) is required, it should be applied after the first coat has reached an initial set but while it is still "green" (less than 48 hours). Curing by misting the coating with water should be done between coats. Ensure first coat is in SSD condition before application of the second coat.

4. For slab (horizontal) applications, care should be taken to spread the Xypex evenly, pulling a heavy broom over the fresh Xypex. This should be done in long strips and will serve to eliminate settlement of the Xypex in low spots on the slab and also to remove excess material which may have been applied.

5. In hot weather it is advisable to apply Xypex either early in the morning or late in the day. This will prevent the Xypex coating from drying out too quickly.

Note: Where a smooth, steel-trowelled finish is required for horizontal slab or where slab will be exposed to traffic (e.g. parking deck), apply Xypex Concentrate DS-1 or DS-2 by dry shake method. The wearability of Xypex Concentrate and Modified can be improved through an application of Xypex Quickset after the coatings have been cured and dried. Contact Xypex's Technical Services Department or your local Xypex Technical Services Representative for further information.

Curing

1. Generally a misty fog spray of clean water is used for curing the Xypex treatment. Curing should begin as soon as the Xypex has set to the point where it will not be damaged by a fine spray of water.

2. Under normal conditions, it is sufficient to spray Xypex treated surfaces three times per day for 2 - 3 days. In hot or arid climates, spraying may be required more frequently to prevent premature drying of the coating. Wet burlap and some specialty curing blankets are also effective for curing. If plastic sheeting is used as protection, it must be raised off the Xypex treatment to allow the coating to breathe.

3. During the curing period, the coating must be protected from rainfall, frost, wind, the puddling of water and temperatures below 36°F (2°C) for a period of not less than 48 hours after application.

CONCRETE COATING INSTALLATION AND PROCEDURES

General Information & Standard Xypex Coating Installation Procedures for Use on Concrete

4. For concrete structures that hold liquids (e.g. swimming pools, reservoirs, wet wells, tanks, etc.), Xypex should be cured for three days and then allowed to set for 12 days before filling the structure with liquid.

5. For structures holding particularly hot and/or corrosive liquids, Xypex should be cured for three days and allowed to set for 18 days before filling.

6. In situations where there is very high humidity and poor air circulation (e.g. small, enclosed reservoirs or wet wells), fans or blown air to create air movement within the space may be necessary to aid the curing of Xypex.

7. Xypex Gamma Cure may be used in lieu of water curing for certain applications: contact Xypex's Technical Services Department or your local Xypex Technical Services Representative. Gamma Cure should be applied using a garden type sprayer and must be diluted as per directions before use. Do not apply more Gamma Cure than is specified.

Backfilling

Backfilling can take place 36 hours after the Xypex application. If backfilling takes place within seven days after the application, the backfilling material should be moist so as not to draw moisture from the Xypex coating.

Application of Paints, Epoxies or Similar Coatings

Xypex requires a minimum of 21 days of curing and crystal generation before the application of any paint or epoxy. Consult epoxy and paint manufacturer for additional coating instructions and restrictions. Removal of the Xypex coating by high pressure washing or abrasive blasting following full curing is the best practice. Alternately, moderate pressure washing, light abrasive blasting or washing the Xypex surface with a 3 - 5% muriatic acid solution followed by a rigorous rinse with clean water is recommended before applying the coating. Be sure to flush all acid off the surface. Prior to the installation, it is recommended that a test section be completed under anticipated ambient and project conditions to demonstrate acceptable bond.

Application of Grout, Cement Parge Coat, Plaster or Stucco

It is recommended that any other cementitious system be applied over the Xypex coating after the Xypex has

completely set but while it is still "green" (8 to 48 hours). The 12 to 24 hour window is considered ideal. Contact Xypex's Technical Services Department or your local Xypex Technical Services Representative regarding surface preparation and other procedures for installations of other materials onto Xypex coatings older than 48 hours. Use of a polymer additive to help improve bond in the over coating mortar mix should be considered. Prior to the installation, it is recommended that a test section be completed under anticipated ambient and project conditions to demonstrate acceptable bond.

Note: Xypex Chemical Corporation makes no representations or warranties regarding the compatibility of Xypex products with plasters, stuccos, tiles and other surface applied materials. It is the responsibility of the installer of these surface-applied materials to take whatever measures are necessary, including testing, to ensure acceptance by or adhesion to the Xypex treated surface.

For more instructions, alternative application methods, or information concerning the compatibility of the Xypex treatment with other products or technologies, contact the Technical Services Department of Xypex Chemical Corporation.

Caution

Xypex is highly alkaline.

1. Avoid contact with skin or eyes.
2. Protect hands with rubber gloves when handling dry powder or wet mixture.
3. If skin comes into contact with Xypex material, wash immediately and thoroughly with water for 15 minutes. If discomfort continues, seek prompt medical attention.
4. Wear eye protection. If dry powder or wet mixture gets into eyes, flush immediately and thoroughly with water and seek medical aid.
5. Wear a suitable mask where there is potential for generating dust. If Xypex is ingested, do not induce vomiting; have affected person drink two glasses of water and obtain immediate medical attention.
6. For Safety Data Sheets, contact Xypex Chemical Corporation at 604.273.5265, toll-free 800-961-4477 or refer to SDS located at: www.xypex.com.

WATERPROOFING OF CMU / CONCRETE BLOCK WALLS

Xypex Recommended Procedure for the Waterproofing of CMU or Concrete Block Structures from Either the Positive or Negative Side

CMU or concrete block is a common building material. However, the pore structure and thus the permeability of these blocks vary greatly from region to region depending on the raw materials used, mix design, manufacturing process and many other factors. As such, the waterproofing of these materials is often difficult. This said, the following procedure has been used to successfully waterproof CMU / concrete block structures against water ingress. While the procedure outlined below is best installed on the positive side, it is used successfully on either the positive or negative side with most applications having been done on the negative side. Due to the high variability in block and the many different scenarios in which block is used the following procedure is not guaranteed to provide a waterproof structure but, Xypex's experience is that this assembly has a very high success rate in most installations.

If the block structure is in an application with high hydrostatic pressures Xypex Megamix II at a thickness of ½" - 1" (12 - 25 mm) may be considered as a replacement for the Xypex Megamix I recommended below. In this scenario a reinforcing mesh mechanically affixed to the substrate may be considered.

STEP 1: Thoroughly clean and profile all concrete surfaces to be treated to remove any overcoating materials or contaminants and to achieve an open pore, "tooth and suction" (ICRI CSP-3) profile.

STEP 2: Repair all cracked, defective, deteriorated mortar or construction joints by removing all mortar in area to 1½" (37 mm) deep or until all unsound mortar is removed. Remove all loose materials within the slot and to 6" (150 mm) on either side of the slot. Clean, profile and saturate this area with water. Allow water to soak into concrete and then remove all surface water. If defective area is actively leaking, apply Xypex Patch'n Plug to the bottom half of the slot to stop active water flow. Coat slot with Xypex Concentrate slurry and fill the remainder of the slot to original level with Xypex Concentrate in Dry-Pac form. If slot is not actively leaking coat slot with Xypex Concentrate slurry and fill entire slot to the original level with Xypex Concentrate Dry-Pac.

STEP 3: If blocks are cracked and leaking or where there is evidence of previous leaking use one of the following procedures

If block voids are filled with concrete or cement based grout – cut a dove tailed slot over the crack 1" (25 mm) wide by 1½" (37 mm) deep and treat per the directions for treatment of mortar or construction joints.

If block voids are not filled they should not be cut into to any significant depth – rout out a shallow slot in the block, following the crack and leaving a depression to receive repair material. Use hammer and chisel, diamond blade or other means appropriate so as not to damage the block. Clean and saturate the slot and the area to 6" (150 mm) on either side of the slot. Fill the slot to the surface and mound over the top of slot and to several inches (cm)

on either side of slot to a depth of approximately ¼" - ½" (6 - 12 mm) with Xypex Patch'n Plug to stop water flow and block the crack. If crack has no indication of active or previous leaking and is less than 1/64" (0.04 mm) wide it may be left untreated.

STEP 4: Wet the surface of the CMU / block until a saturated surface dry (SSD) condition is obtained. Saturated surface dry CMU / block will not absorb any further water but has no glistening water on its surface. Maintain the CMU / block in an SSD condition until Xypex material is applied.

STEP 5: Coat surface of designated area with one coat of Xypex Concentrate at the rate of 2 lb./sq.yd. (1 kg/m²) as per manufacturer's standard specifications.

STEP 6: Allow Xypex Concentrate coating to set and harden for between 12 hours and 24 hours. During this time, moist cure coating per Xypex product data sheet.

STEP 7: Mix Xypex Megamix I with Xycrylic Admix as per product data sheet instructions.

STEP 8: Apply one coat of Megamix I over top of Xypex Concentrate coating at a thickness of 1/8" (3 mm) or 11.25 lb./sq.yd. (5.6 kg/m²). The thickness of the top coating may be varied from 1/16" - 3/8" (1.5 - 10 mm) per job conditions and requirements. Dampen Xypex Concentrate surface ahead of application of Megamix I as required to maintain a damp but not glistening substrate (saturated surface dry condition).

STEP 9: In most situations, no moist curing of Xypex Megamix I is required but in rapid drying conditions, Megamix I should be allowed to fully set and then be misted periodically to keep moist for 24 hours.

WATERPROOFING OF CMU / CONCRETE BLOCK WALLS

Xypex Recommended Procedure for the Waterproofing of CMU or Concrete Block Structures from Either the Positive or Negative Side

Prior to the installation, it is recommended that a test section be completed under anticipated ambient and project conditions to demonstrate acceptable bond.

This procedure will usually provide a waterproof block wall for the life of the structure.

It is necessary to allow at least 30 days or longer at normal room temperatures for crystalline growth to form to a level that will indicate the expected level of performance of the above treatment. Lower temperatures will extend the times for crystalline development.

Re-application of Xypex Megamix I (or Xypex Megamix II – high strength structural mortar repair) may be required for reinforcement at the most severe points of leakage or

weakened areas of wall. Be sure to lightly acid wash and thoroughly rinse the existing coating of Xypex Megamix I prior to subsequent applications. In locations of ongoing active leaking Xypex Patch'n Plug may be required to stop active water flow.

As previously discussed, the waterproofing effectiveness of the above procedures and recommendations is very dependent on the quality and porosity of the CMU or concrete block installed. Further, installation of Xypex products by a qualified installer, especially for CMU / concrete block waterproofing applications, is highly recommended.

Contact Xypex's Technical Services Department for assistance.

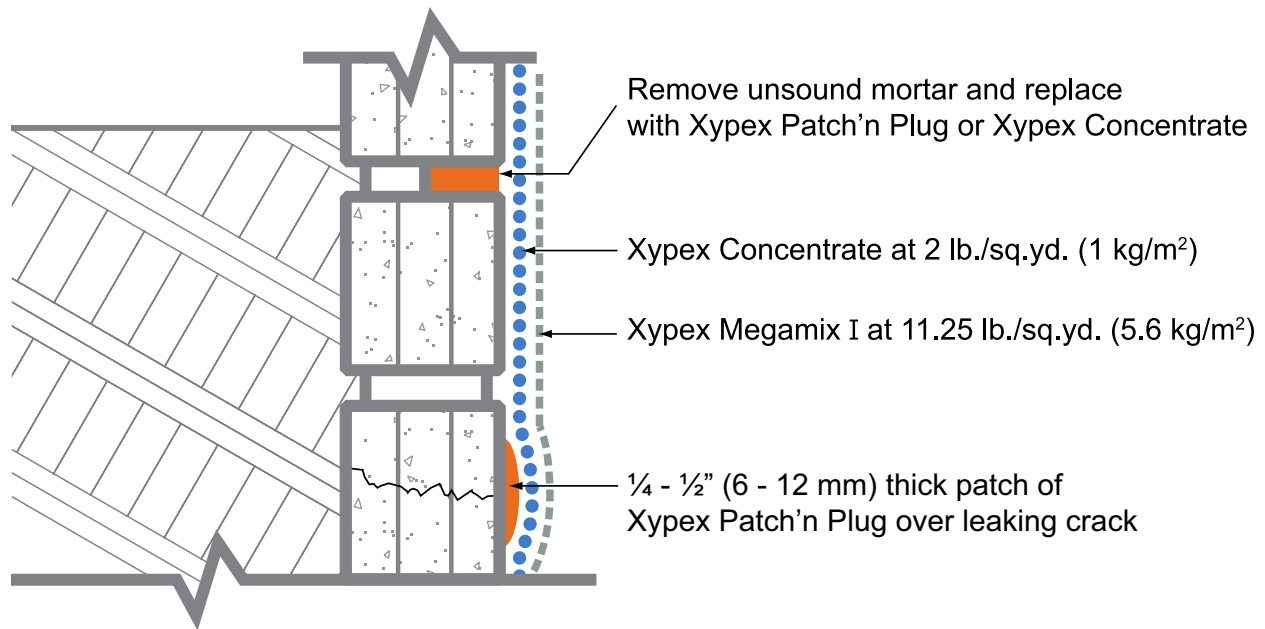

FAST TRACK COATING SYSTEM

Xypex Coating System for Early Exposure to Water

Xypex treatment of existing concrete water holding structures typically requires one of the following. Either one or two coats of Xypex Concentrate or one coat of Xypex Concentrate and one coat of Xypex Modified followed by 3 days of moist curing and then an additional 12 days of drying and hardening (18 days of drying and hardening prior to immersion if the water is waste contaminated). This relatively long curing and hardening period can create challenges if the project time line needs to be fast tracked or there is significant water runoff such that the environment will be virtually the same as full water immersion.

The following procedure can be used to allow a rapid return to service of the Xypex coated water holding structures (3 - 4 days from the start of application of the materials).

STEP 1: Thoroughly clean and profile all concrete surfaces to be treated to remove any overcoating materials or contaminants and to achieve an open pore, “tooth and suction” (ICRI CSP-3) profile.

STEP 2: Repair joint lines, cracks and surface defects if required as per Xypex standard repair procedures.

STEP 3: Wet the surface of the concrete until a saturated surface dry (SSD) condition is obtained. SSD concrete will not absorb any further water but has no glistening water on its surface. Maintain the concrete in an SSD condition until Xypex material is applied.

STEP 4: Coat surface of designated area with one coat of Xypex Concentrate at the rate of 2 lb./sq.yd. (1 kg/m²) as per manufacturer’s standard specifications.

STEP 5: Allow Xypex Concentrate coating to set and harden for between 12 hours and 24 hours. During this time, moist cure coating per Xypex product data sheet.

STEP 6: Mix Xypex Megamix I with Xycrylic Admix as per product data sheet instructions.

STEP 7: Apply one coat of Megamix I over top of Xypex Concentrate coating at an average thickness of 1/8” (3 mm) or 11.25 lb./sq.yd. (5.6 kg/m²). The top coating thickness may be varied from 1/16” - 3/8” (1.5 - 10 mm) as per job conditions and requirements. Dampen Xypex Concentrate surface ahead of application of Megamix I as required to maintain an SSD condition.

STEP 8: Allow Xypex Megamix I to harden and cure for 2 - 3 days.

Prior to the installation, it is recommended that a test section be completed under anticipated ambient and project conditions to demonstrate acceptable bond.

Note:

- i. In most situations, no moist curing of Xypex Megamix I is required but in rapid drying conditions, Megamix I should be allowed to fully set and then be misted periodically to keep moist for 24 hours.
- ii. The above are recommended time frames only. If project requirements are such that these cannot be met, contact Xypex’s Technical Services Department.
- iii. See the Xypex Concentrate and Megamix I product data sheets for further detailed information and procedures.

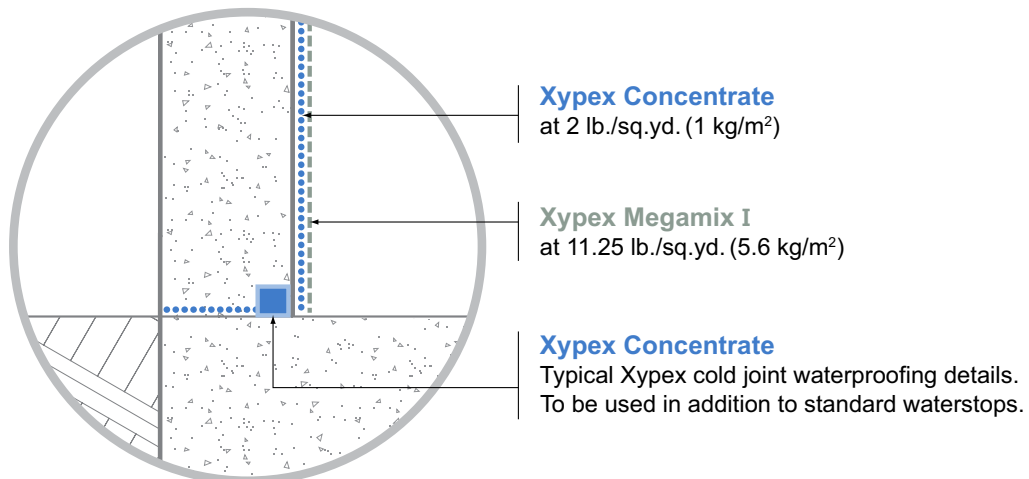

WATERPROOFING OF DRY MIX SHOTCRETE / EXISTING CONCRETE POOLS

Xypex Coating Procedures for the Waterproofing of Dry Mix Shotcrete (Gunitite) / Existing Concrete Pools, Fountains or Other Structures That Will Be Receiving Additional Finishes

A common application for the Xypex coating system is the waterproofing of shotcrete or gunite formed pools and fountains that will ultimately be finished with tile or plaster. Following is the recommended procedure for waterproofing these structures using Xypex coating materials. These same procedures could also be used for waterproofing of cast in place concrete pool structures that do not contain Xypex Admix in the concrete.

Application of Xypex Coating

Surface Preparation: Thoroughly clean and profile all concrete surfaces to be treated to remove any overcoating materials or contaminants and to achieve an open pore, “tooth and suction” (ICRI CSP-3) profile on the concrete pool shell.

Repair of Defects: Surface defects shall be repaired in accordance with manufacturer’s technical literature and Method Statements (www.xypex.com). Procedures are generally as follows:

1. Cracks and Faulty Construction Joints: Chip out joint gaps and cracks creating a “U” shaped slot 1” (25 mm) wide and a minimum of 1 ½” (37 mm) deep. The slot may be saw cut instead of chipped but ensure that the slot is dovetailed or otherwise shaped such that there will be mechanical interlock of materials placed into the slot at a later stage. Clean slot of debris and dust. Soak area with water and remove excess surface water. Apply a slurry coat of Xypex Concentrate at the rate of 1.5 lb./sq.yd. (0.8 kg/m²) into the slot. While the slurry coat is still tacky fill cavity with Concentrate Dry-Pac. Compress Dry-Pac tightly into cavity using pneumatic packer or block and hammer. For cracks or joints that have active water leaking see Method Statements or contact Xypex Technical Services.

2. Rock Pockets, Honeycombing or Other Defective Concrete: Saw cut around the affected area and chip out defective material to sound concrete. Pressure wash the area to remove loose materials and to saturate the substrate with water. Remove excess surface water and apply a scrub coat of the Xypex Megamix II repair mortar. Fill cavity to surface level with Xypex Megamix II (for small repairs substitute Xypex Patch’n Plug for Megamix II). Cure per manufacturer’s recommendations.

Wetting Concrete: Prior to application of waterproofing treatment, thoroughly saturate concrete surfaces with clean water to provide a saturated, surface dry (SSD) condition. SSD concrete will not absorb any more water but has no glistening water on the surface. Remove free-standing surface water before application. An SSD condition is required to ensure migration of crystalline chemicals into voids and capillary tracts of the concrete.

Surface Application: After concrete repairs, surface preparation and treatment of construction joints and cracks have been completed (in accordance with manufacturer’s product literature and as specified herein), apply Xypex treatment. A single coat of Xypex Concentrate shall be applied uniformly to concrete surfaces with semi-stiff bristle brush, broom or suitable spray equipment. Application rates shall be at 2 lb./sq.yd. (1 kg/m²) and in accordance with manufacturer’s product data. When brushing, work slurry well into the concrete surface, filling pores and hairline cracks. When spraying, hold nozzle close enough to ensure that slurry is forced into pores and hairline cracks.

Curing: Begin curing as soon as Xypex coating has hardened sufficiently so as not to be damaged by a fine spray. Cure Xypex treatment with a mist fog spray of clean water three times a day for 2 - 3 days, or cover treated surfaces with damp burlap for the prescribed period. In warm climates, more than three sprayings per day may be necessary to prevent excessive drying of coating. Pooling or puddling of water is not acceptable. The use of some specialty curing blankets are also effective for curing, especially on horizontal surfaces. Xypex Gamma Cure can be used especially in hot, dry or windy conditions to lessen the need for misting. Coating must be kept “green looking” for 2 - 3 days.

As described in the following sections of this method statement, the above curing regime will be shortened if the “Early Installation Option” is used.

WATERPROOFING OF DRY MIX SHOTCRETE / EXISTING CONCRETE POOLS

Xypex Coating Procedures for the Waterproofing of Dry Mix Shotcrete (Gunite) / Existing Concrete Pools, Fountains or Other Structures That Will Be Receiving Additional Finishes

Installation of Thinset and Tile or Plaster

There are two alternatives for the application of additional cementitious materials systems over Xypex Concentrate.

Early Installation Option: After Xypex Concentrate has reached a final set and within 48 hours (the 12 - 24 hour window is considered ideal), thinset, mortar or plaster may be applied directly to the Xypex Concentrate coating. Mortars should contain an acrylic polymer to assist in bonding to the Xypex Concentrate coating. During the time between installation of the Xypex Concentrate onto the substrate and the application of the thinset or pool plaster the Xypex coating must be kept “green looking” using the curing methods described above. The brush or spray applied finish of the Xypex coating is normally an acceptable profile for subsequently applied materials but this must be confirmed with the over coating material’s manufacturer. Maintenance of the Xypex coating in an SSD condition (or not) during application of other cementitious materials should be confirmed with those products’ manufacturers.

Standard Installation Option: After the 2 - 3 day curing period allow Xypex Concentrate to remain on the substrate undisturbed for 21 days. After that time, one of the following methods should be used to prepare the surface for application of the thinset, mortar or plaster:

BEST – Completely remove the Xypex Concentrate coating by sand blasting, wet blasting or water jetting. 5,000 psi (350 bar) is normally acceptable to achieve full removal of the Xypex coating. Additional cleaning of the substrate shall be done such that it is left clean of dust or any other residue. The surface profile and other properties of the substrate shall be as required by the over coating material’s manufacturer. After 21 days there has been sufficient chemical transfer of Xypex active ingredients into the substrate concrete that removal of the coating will not adversely affect the performance of the Xypex waterproofing.

BETTER – High pressure wash the Xypex Concentrate coating with 3,000 - 3,500 psi (200 - 350 bar) water to remove as much Xypex Concentrate coating as will easily come off with this level of pressure washing. Then wash any remaining Xypex Concentrate coating with a 3% - 5% acid solution to open the pores of the coating and remove any surface crystallization. Thoroughly flush off any acid residue from treated surfaces. Confirm the surface is acceptable to the over coating material’s manufacturer.

ACCEPTABLE – Acid wash the Xypex Concentrate coating with a 3% - 5% acid solution to open the pores of the coating and remove any surface crystallization that may have formed. Thoroughly flush off any remaining acid or residue from treated surfaces.

In this scenario the surface preparation of the substrate prior to application of the Xypex Concentrate is critical. The bond of the Xypex Concentrate to the substrate is not being tested by pressure washing and the adhesion of the entire system is dependent on the bond of the Concentrate layer to the substrate. Confirmation of the acceptability of the Xypex coating surface to the over coating material’s manufacturer is recommended.

Xypex accepts no responsibility regarding bond between the Xypex Concentrate and the subsequently applied materials. Prior to the installation, it is recommended that a test section be completed under anticipated ambient and project conditions to demonstrate acceptable bond.

Note: Xypex Chemical Corporation makes no representations or warranties regarding the compatibility of Xypex products with plasters, stuccos, tiles and other surface-applied materials. It is the responsibility of the installer of these surface-applied materials to take whatever measures are necessary, including testing, to ensure acceptance by or adhesion to the Xypex treated surface.

Xypex does not recommend the use of Xypex Concentrate as an aesthetic surface finish in any water retaining structure applications.

WATERPROOFING OF STONE AND BRICK WALLS

Xypex Recommended Procedure for the Waterproofing of Mortared Natural Stone or Clay Brick Structures from Either the Positive or Negative Side

While not often used today, clay brick and natural stone were common building materials in the past and many below grade structures built with brick and stone are still in use today.

The following methodology has been used to successfully waterproof clay brick and stone structures against water ingress. While the procedure outlined below is best installed on the positive side, it is used successfully on either the positive or negative side with most applications having been done on the negative side. Due to the high variability in brick and stone and the many different scenarios in which these materials are used the following procedure does not typically provide a waterproof structure with the first installation but more likely requires call backs to further mitigate more persistent leaks. Even with the most diligent application of Xypex materials complete waterproofing of a brick or stone wall cannot be guaranteed. This said, Xypex’s experience is that with these procedures and diligent follow up, an adequate success rate is achieved in most installations.

If the structure is in an application with high hydrostatic pressures Xypex Megamix II at a thickness of ½” (12 mm) to 1” (25 mm) may be considered as a replacement for the Xypex Megamix I recommended below. In this scenario a reinforcing mesh mechanically affixed to the substrate may be considered.

STEP 1: Ensure that the wall is structurally sound, with surfaces free of any foreign material. Thoroughly clean and profile all concrete surfaces to be treated including mortar joints to remove any overcoating materials or contaminants and to achieve an open pore, “tooth and suction” (ICRI CSP-3) profile.

STEP 2: Repair all cracked, defective, deteriorated mortar, and construction joints by removing all mortar in the area to 1½” (37 mm) deep or until all unsound mortar is removed. Remove all loose materials within the slot and clean and saturate this area with water. Allow water to soak into mortar and then remove all surface water. If defective area is actively leaking, apply Xypex Patch’n Plug to the bottom half of the slot to stop active water flow. Coat slot with Xypex Concentrate slurry and fill remainder of slot to original level with Xypex Concentrate in Dry-Pac form. If slot is not actively leaking coat slot with Xypex Concentrate slurry and fill entire slot to the original level with Xypex Concentrate Dry-Pac.

STEP 3: If bricks or stone are cracked and leaking or where there is evidence of previous leaking: rout out a shallow slot in the brick, following the crack, and leaving a depression to receive repair material. Use hammer and chisel, diamond blade or other means appropriate so as not to damage the brick. Clean and saturate the slot and the area to 6” (150 mm) on either side of the slot. Fill the slot to the surface and mound over the top of slot and to several inches (cm) on either side of slot to a depth of approximately ¼” - ½” (6 - 12 mm) with Xypex Patch’n Plug (if the stone cannot be chipped then just mound over the crack per above) to stop water flow and block the crack. If crack has no indication of active or previous leaking it may be left as is.

STEP 4: Wet the surface of the stone or brick wall until a saturated surface dry (SSD) condition is obtained. Saturated surface dry surfaces will not absorb any further water but have no glistening water on their surface. Maintain the stone or brick wall in an SSD condition until Xypex material is applied.

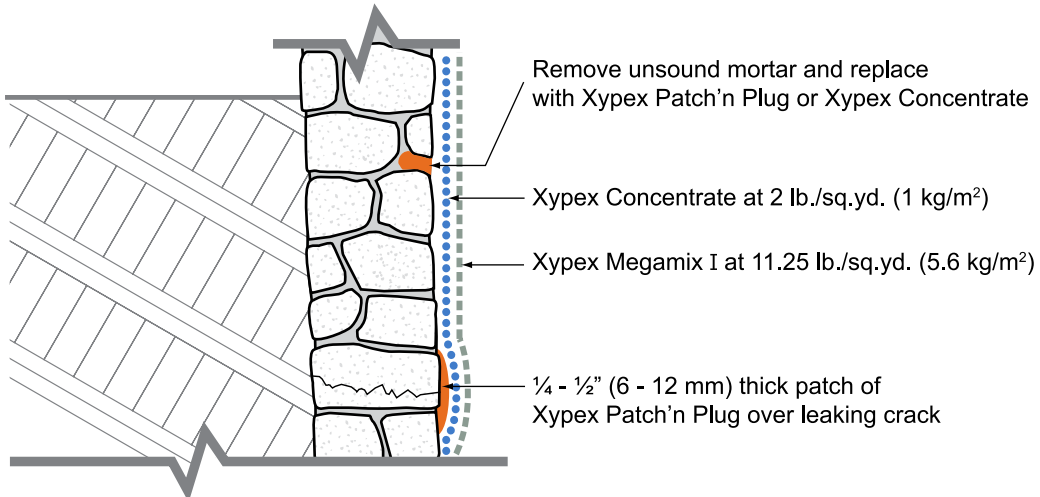

WATERPROOFING OF STONE AND BRICK WALLS

Xypex Recommended Procedure for the Waterproofing of Mortared Natural Stone or Clay Brick Structures from Either the Positive or Negative Side

STEP 5: Coat surface of designated area with one coat of Xypex Concentrate at the rate of 2 lb./sq.yd. (1 kg/m²) as per manufacturer's standard specifications. Uniformly apply Concentrate slurry to brick or stone surfaces using a semi-stiff bristle brush and taking care to ensure good coverage of the mortar joints. Work slurry well into surface, filling surface pores and hairline cracks.

STEP 6: Allow Xypex Concentrate coating to set and harden for between 12 hours and 24 hours. During this time, moist cure coating per Xypex product data sheet.

STEP 7: Mix Xypex Megamix I with Xycrylic Admix as per product data sheet instructions.

STEP 8: Apply one coat of Megamix I over top of Xypex Concentrate coating at a thickness of 1/8" (3 mm) or 11.25 lb./sq.yd. (5.6 kg/m²). The thickness of the top coating may be varied from 1/16" - 3/8" (1.5 - 10 mm) per job conditions and requirements. Dampen Xypex Concentrate surface ahead of application of Megamix I as required to maintain a damp but not glistening substrate (saturated surface dry condition).

STEP 9: In most situations, no moist curing of Xypex Megamix I is required but in rapid drying conditions, Megamix I should be allowed to fully set and then be misted periodically to keep moist for 24 hours.

Prior to the installation, it is recommended that a test section be completed under anticipated ambient and project conditions to demonstrate acceptable bond.

It is necessary to allow at least 30 days or longer at normal room temperatures for crystalline growth to form to a level that will indicate the expected level of performance of the Xypex treatment. Lower temperatures will extend the times for crystalline development.

Re-application of Xypex Megamix I (or Xypex Megamix II – high strength structural mortar repair) may be required for reinforcement at the most severe points of leakage or weakened areas of wall. Be sure to lightly acid wash and thoroughly rinse the existing coating of Xypex Megamix I prior to subsequent applications. In locations of ongoing active leaking Xypex Patch'n Plug may be required to stop active water flow.

As previously discussed, the waterproofing effectiveness of the above procedures and recommendations is very dependent on the quality and porosity of the brick or stone structure originally installed. A fully waterproof brick or stone wall cannot be guaranteed even after strict adherence to the recommendations given in this guide. Further, installation of Xypex products by a qualified installer, especially for brick and stone waterproofing applications, is highly recommended.

Contact your Xypex's Technical Services Department for assistance.

WATERPROOFING CONCRETE TIE HOLES USING XYPEX

There are several ways of holding forms together during placement of concrete. Most of these methods involve the use of some type of steel tie that connects the forms together and holds them from spreading. These ties inevitably leave a leak path for water and need to be detailed in order to achieve a waterproof structure.

The following provides one recommended procedure for waterproofing each of the four most common types of concrete ties: spacer tube assembly ties, gang form taper ties, cone snap ties and flat bar snap ties. If coil ties, other ties whereby part of their assembly remains in the concrete, or some other type of tie not covered in this document is used, a modification of these procedures to fit that situation would be recommended. Contact Xypex's Technical Services Department for assistance.

These procedures are meant for use with tie holes that are not actively leaking. If tie holes are leaking see the Xypex "Repair of Leaking Tie Holes" Method Statement or contact Xypex's Technical Services Department for assistance.

Waterproofing Spacer Tube Assembly Tie Holes

As illustrated below, spacer tube assembly ties include an appropriate length and diameter plastic tube that has cone shaped inserts in the ends. These act as a spacer assembly between the forms. A threaded rod runs through the forms and tube and is bolted tight to hold the forms together. The following procedure is for the waterproofing of the through element holes left after removal of the steel rods, cone inserts and other forming hardware.

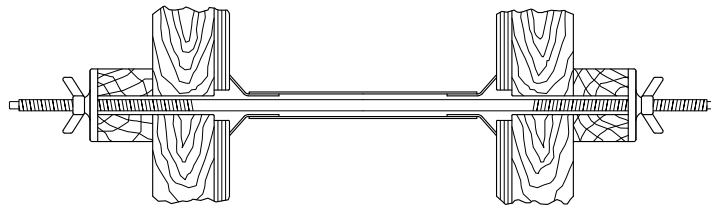

The following installation is best performed from the positive or wet side of the concrete element although it can also be done from the negative or dry side.

STEP 1: Using a hammer drill bit that is slightly larger than the outside diameter of the plastic tube, drill out to a depth of at least 5" (125 mm) the plastic spacer tube leaving the inner wall of the hole rough and free of any plastic debris.

STEP 2: Remove all loose material within the void and to a 12" (300 mm) diameter area around the void. Clean, profile (ICRI CSP-3) and saturate this area with water. Allow water to soak into the concrete and then remove all surface water. All surfaces should be left saturated surface dry (SSD – wet but with no glistening water).

STEP 3: Compact a quantity of Xypex Patch'n Plug into the bottom of the prepared section of the hole to form a plug. The plug is to be at least a 1" (25 mm) thick. There must remain at least a 4" (100 mm) of space between the top of the Patch'n Plug and the surface of the concrete element. Alternately insert an appropriately sized rubber stopper or commercially available rubber stopper device (such as a Flupp 22 ST) into hole and seat the stopper soundly into the top of the remaining plastic tube. (See the Taper Tie Assembly illustrations for rubber stopper example).

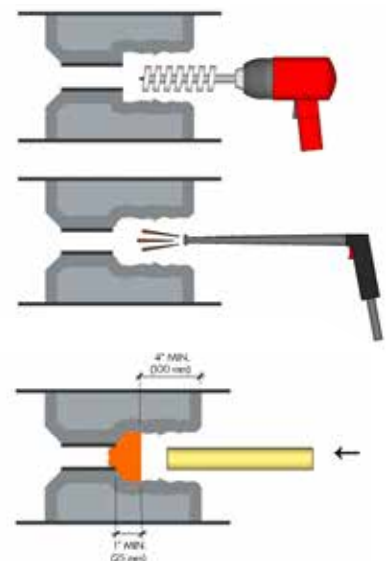

WATERPROOFING CONCRETE TIE HOLES USING XYPEX

STEP 4: Apply one slurry coat of Xypex Concentrate at a coverage of 1.5 lb./sq. yd. (0.8 kg/m²) to inside of the void and to a 12" (300 mm) diameter area around the hole. Application may be performed by brush or gloved hand.

STEP 5: While slurry coat is still tacky, fill the void to the surface with Xypex Concentrate mixed in the following proportions: one part clean water to six parts Concentrate by volume to create a Dry-Pac. Blend Dry-Pac by trowel for 10 to 15 seconds only (lumps should be present in the mixture). Fill the hole fully compacting Xypex Concentrate Dry-Pac using a pneumatic packing device or a hammer and dowel.

STEP 6: Wet the Dry-Pac surface lightly with water, then apply a slurry coat of Xypex Concentrate at a coverage of 1.5 lb./sq.yd. (0.8 kg/m²) over the repaired area to a 12" (300 mm) diameter area around the filled void.

STEP 7: Cure by keeping moist by fog spraying periodically with water for two to three days. Open to water contact per Xypex Coatings guidelines.

Note:

When early exposure to water is required:

1. In Step 5 – replace the top 1/4" - 1/2" (6 - 12 mm) of Xypex Concentrate Dry-Pac with Xypex Patch'n Plug.
2. Step 6 and Step 7 – eliminate.

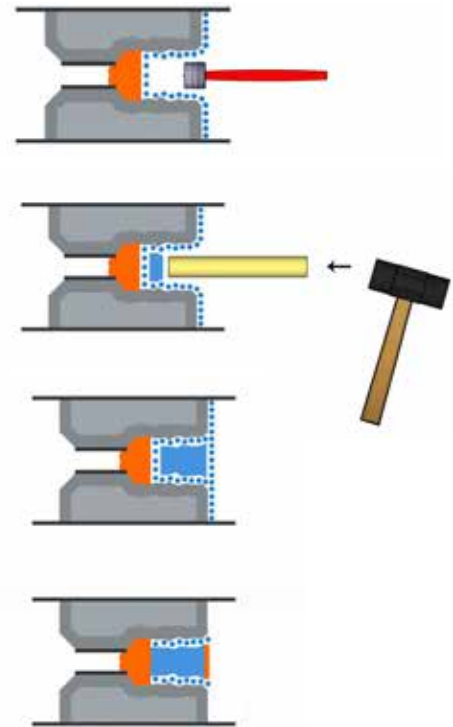

Waterproofing Gang Form Taper Tie Holes

As illustrated below, taper ties are long steel bars that are threaded at each end and have a slight taper through the full length of the bar between the threaded areas. They are usually used in thick section walls of 20" (500 mm) or more.

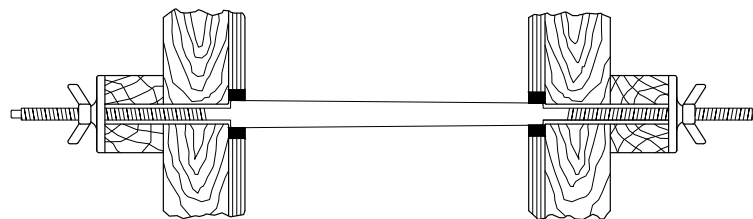

The following procedure is meant for use when waterproofing a thick section wall. If the concrete section is thinner than 10" (250 mm) contact Xypex Technical Services for assistance. The following installation is meant to be installed from the positive or wet side of the concrete element although it can also be done from the negative or dry side.

STEP 1: Using a hammer drill bit that is slightly larger than the outside diameter of the taper tie hole, drill out the hole to a depth of at least 5" (125 mm) leaving the inner wall of the hole rough.

STEP 2: Remove all loose material within the void and to a 12" (300 mm) diameter area around the void. Clean, profile (ICRI CSP-3) and saturate this area with water. Allow water to soak into concrete and then remove all surface water. All surfaces should be left saturated surface dry (SSD – wet but with no glistening water).

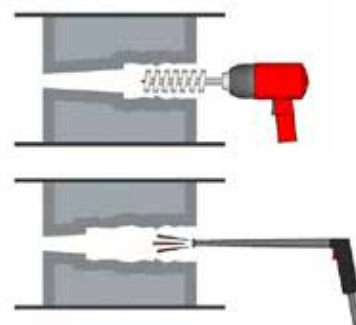

WATERPROOFING CONCRETE TIE HOLES USING XYPEX

STEP 3: Insert into the smooth sided tie hole (at the bottom of the drilled out area) an appropriately sized rubber stopper or commercially available rubber stopper device. Alternatively, compact a quantity of Xypex Patch'n Plug into the bottom of the prepared section of the hole to form a plug. The plug is to be at least a 1" (25 mm) thick. There must remain at least a 4" (100 mm) of space between the top of the Patch'n Plug and surface of the concrete element (See the Spacer Tube Assembly illustrations for Patch'n Plug example).

STEP 4: Apply one slurry coat of Xypex Concentrate at a coverage of 1.5 lb./sq.yd. (0.8 kg/m²) to inside of the void to a 12" (300 mm) diameter area around the hole. Application may be performed by brush or gloved hand.

STEP 5: While slurry coat is still tacky, fill the void to the surface with Xypex Concentrate mixed in the following proportions: one part clean water to six parts Concentrate by volume to create a Dry-Pac. Blend Dry-Pac by trowel for 10 to 15 seconds only (lumps should be present in the mixture). Fill the hole fully compacting Xypex Concentrate Dry-Pac using a pneumatic packing device or a hammer and dowel.

STEP 6: Wet the Dry-Pac surface lightly with water, then apply a slurry coat of Xypex Concentrate at a coverage of 1.5 lb./sq.yd. (0.8 kg/m²) over the repaired area to a 12" (300 mm) diameter area around the filled void.

STEP 7: Cure by keeping moist by fog spraying periodically with water for two to three days. Open to water contact per Xypex Coatings guidelines.

Note:

When early exposure to water is required:

1. In Step 5 – replace the top 1/4" - 1/2" (6 - 12 mm) of Xypex Concentrate Dry-Pac with Xypex Patch'n Plug.
2. Step 6 and Step 7 – eliminate.

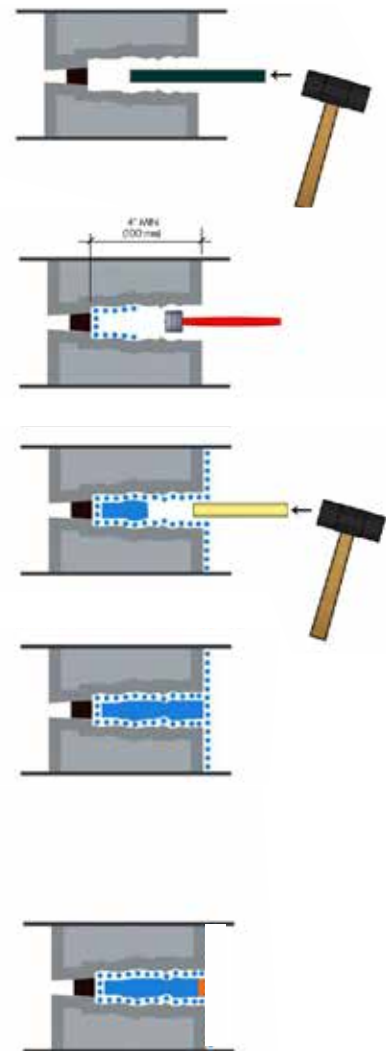

WATERPROOFING CONCRETE TIE HOLES USING XYPEX

Snap Ties with Cone Spreaders

The following procedure is meant for snap cone ties that leave a solid steel rod through the concrete and a cone-shaped impression approximately 1" x 1.5" (25 mm x 37 mm) deep, at the surface of the concrete. When specifying form ties for a project, Xypex recommends a cone depth of greater than 1.5" (37 mm) and that ties have a built in waterstop included.

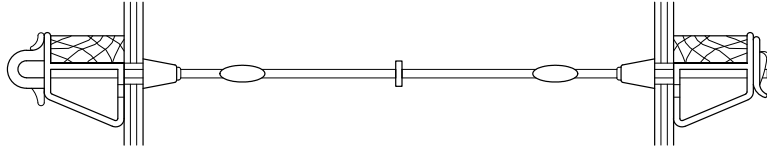

STEP 1: Using a hammer drill, or chisel bit that is slightly larger than the outside diameter to the cone, drill out or chip out the cone shape to the full depth of the indentation leaving a rough surfaced, straight sided void.

STEP 2: Remove all loose material within the void and to a 12" (300 mm) diameter area around the void. Clean, profile (ICRI CSP-3) and saturate this area with water. Allow water to soak into concrete and then remove all surface water. All surfaces should be left saturated surface dry (SSD – wet but with no glistening water).

STEP 3: Apply one slurry coat of Xypex Concentrate at a coverage of 1.5 lb./sq.yd. (0.8 kg/m²) to inside of the void to a 12" (300 mm) diameter area around chipped void. Application may be performed by brush or gloved hand.

STEP 4: While slurry coat is still tacky, fill the void to the surface with Xypex Concentrate mixed in the following proportions: one part clean water to six parts Concentrate by volume to create a Dry-Pac. Blend Dry-Pac by trowel for 10 to 15 seconds only (lumps should be present in the mixture). Apply Dry-Pac by gloved hand, then compress it tightly using a pneumatic packing device or a hammer and dowel.

STEP 5: Wet Dry-Pac surface lightly with water, then apply a slurry coat of Xypex Concentrate at a coverage of 1.5 lb./sq.yd. (0.8 kg/m²) over the repaired area to a 12" (300 mm) diameter area around the filled void.

STEP 6: Cure by keeping moist by fog spraying periodically with water for two to three days. Open to water contact per Xypex Coatings guidelines.

Note:

When early exposure to water is required:

1. In Step 4 – replace the top 1/4" - 1/2" (6 - 12 mm) of Xypex Concentrate Dry-Pac with Xypex Patch'n Plug.
2. Step 5 and Step 6 – eliminate.

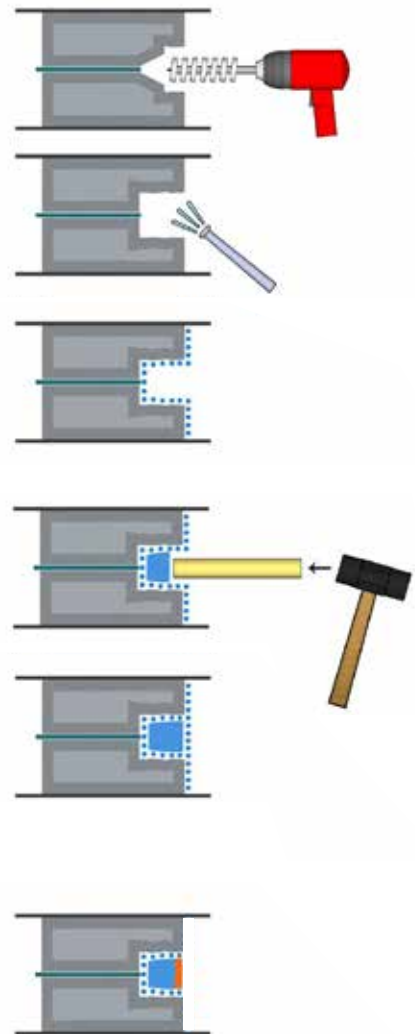

WATERPROOFING CONCRETE TIE HOLES USING XYPEX

Flat Bar Snap Ties

Flat bar snap ties are typically not used for water retaining structures or significant foundations works but are used for below grade foundations that may require waterproofing.

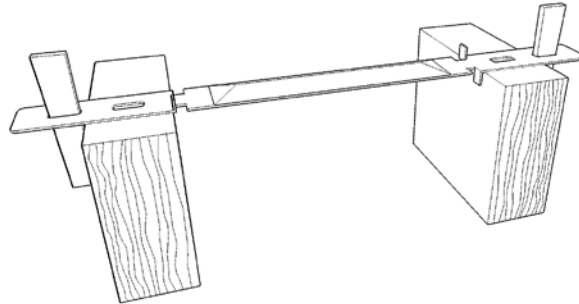

Most flat bar snap ties are designed to break back approximately $\frac{1}{4}$ " (6 mm) below the surface of the concrete.

STEP 1: Remove all loose material to a 12" (300 mm) diameter area around the tie. Clean, profile (ICRI CSP-3) and saturate this area with water. Allow water to soak into concrete and then remove all surface water. All surfaces should be left saturated surface dry (SSD – wet but with no glistening water).

STEP 2: Apply one slurry coat of Xypex Concentrate at coverage of 1.5 lb./sq.yd. (0.8 kg/m²) to a 12" (300 mm) diameter circle around the tie. Application may be performed by brush or gloved hand.

STEP 3: Mix Xypex Patch'n Plug to a mortar consistency and while slurry coat is still tacky, fill any depression around tie hole as well as mounding the Patch'n Plug over the area to a depth of approximately $\frac{1}{2}$ " (12 mm). The Patch'n Plug mound should be approximately 6" (150 mm) in diameter centered over the tie.

STEP 4: For added protection cover entire repair area with one coat of Xypex FCM 80 at $\frac{1}{16}$ " (1.5 mm) thickness.

Note:

The above procedure recommends Xypex Concentrate in Dry-Pac and Xypex Patch'n Plug as the materials to use to fill tie holes. Xypex is aware that blends of Xypex Concentrate and Xypex Patch'n Plug powders are also utilized in place of the Xypex Concentrate Dry-Pac. The blends normally consist of between 20% Concentrate and 80% Patch'n Plug to 80% Concentrate and 20% Patch'n Plug. These blends are typically used in a mortar consistency and have the advantage of ease of placement as well as rapid set while being able to be reworked in the hand, for several minutes, back to a mortar consistency. While Xypex recommends 100% Concentrate in Dry-Pac as the primary filling material for tie holes, Xypex allows the use of the blends described above for these and other applications.

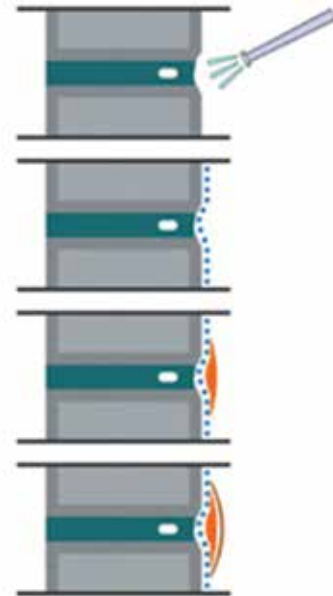

XYPEX WATERPROOFING OF ANNULAR SPACES

Waterproofing of Annular Spaces Surrounding Through Concrete Utilities

Pipes and conduits that are installed through round or square block outs in concrete are a common part of concrete construction. The following are procedures for waterproofing of the annular spaces that are created between the edge of the concrete and conduit, pipe or other utility feature after its installation through the wall or slab. These details are based on circular “block out” shapes but may be modified for other shapes as appropriate. These procedures are appropriate for many common piping materials including steel, iron, PVC and HDPE.

Note that fluid bearing pipes may vibrate or move due to the hydraulics within the system or thermal expansion and contraction. This type of ongoing movement may interrupt the crystalline based healing. In these cases contact Xypex Technical Services for assistance.

For Annular Space Gaps of 1” (25 mm) or Less

STEP 1: Remove all loose materials and thoroughly clean and profile (ICRI CSP-3) the inner surface of the concrete void and the surface of the concrete to a 6” (150 mm) area around the block out. Clean and roughen to as far through the wall or slab as possible. Lightly sand and clean as much of the surface of the pipe / conduit as possible to provide a profile. Saturate the prepared concrete with water. Allow water to soak into concrete and then remove all surface water.

STEP 2: Apply one slurry coat of Xypex Concentrate at a coverage rate of 1.5 lb./sq.yd. (0.8 kg/m²) onto the pipe / conduit, to the surface of the concrete in the block out and to the surface of the concrete to 6” (150 mm) around the block out. Apply through the full depth of the concrete. Application may be performed by brush or gloved hand.

STEP 3: On the wet side of the wall or slab, while slurry coat is still tacky, apply Xypex Patch’n Plug into the space to a depth of 2” - 3” (50 - 75 mm) to create a solid ring of Patch’n Plug material. Finish the Patch’n Plug flush with the surface of the concrete.

STEP 4: While slurry coat is still tacky, fill the space behind the Patch’n Plug to the surface of the concrete with Xypex Concentrate Dry-Pac mixed in the following proportions: one part clean water to six parts Concentrate by volume. Blend Dry-Pac by trowel for 10 - 15 seconds only (lumps should be present in the mixture). Apply Dry-Pac by gloved hand, and then compress it tightly using a pneumatic packing device or a hammer and block.

STEP 5: Wet the surface of the Dry-Pac lightly with water, then apply a slurry coat of Xypex Concentrate at coverage rate of 1.5 lb./sq.yd. (0.8 kg/m²) over the filled area and to 6” (150 mm) onto the slab away from the space.

STEP 6: Cure by keeping moist by fog spraying periodically with water for two to three days. Open to water contact per Xypex Coatings guidelines.

Note:

If the concrete does not contain Xypex Admix then also apply Xypex Concentrate slurry coat to the Patch’n Plug side per Step 5. Contact Xypex’s Technical Services Department or your local Xypex Technical Services Representative regarding appropriate time for exposure to water contact.

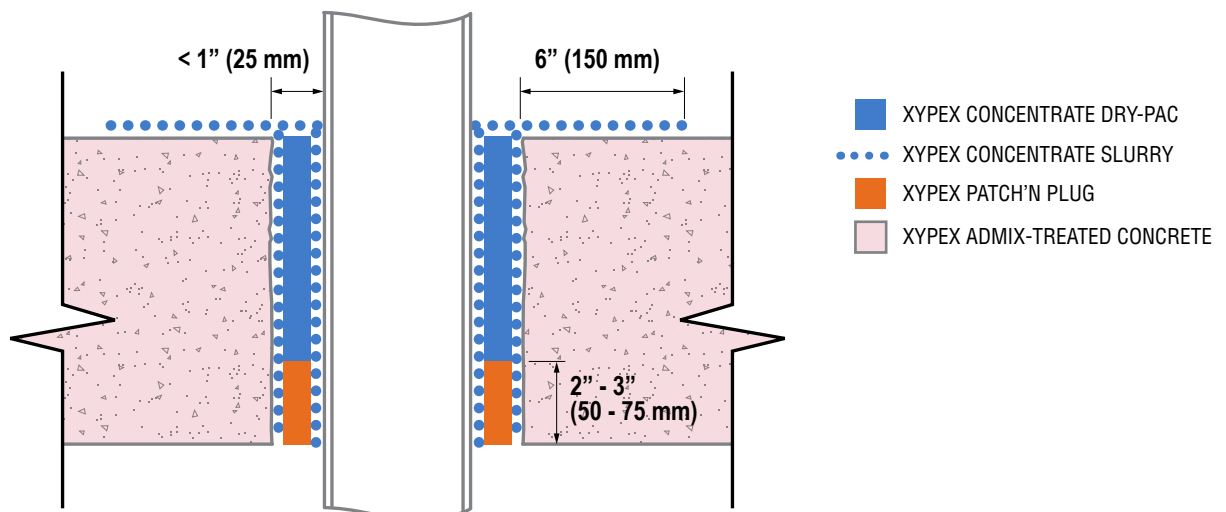

XYPEX WATERPROOFING OF ANNULAR SPACES

Waterproofing of Annular Spaces Surrounding Through Concrete Utilities

**For Annular Space Gaps
Between 1" - 4" (25 - 100 mm)**

STEP 1: Remove all loose materials and thoroughly clean and profile (ICRI CSP-3) the inner surface of the concrete void and the surface of the concrete to 6" (150 mm) around the block out. Clean and roughen all the way through the wall or slab. Lightly sand and clean the surface of the pipe / conduit to provide a profile. Saturate the prepared concrete with water. Allow water to soak into concrete and then remove all surface water.

STEP 2: Apply one slurry coat of Xypex Concentrate at a coverage rate of 1.5 lb./sq.yd. (0.8 kg/m²) onto the pipe / conduit, to the surface of the concrete in the block out and to the surface of the concrete to 6" (150 mm) around the block out. Apply through the full depth of the concrete. Application may be performed by brush or gloved hand.

STEP 3: On the wet side of the wall or slab, while slurry coat is still tacky, apply Xypex Patch'n Plug into the space to a depth of 2" - 3" (50 - 75 mm) to create a solid ring of Patch'n Plug material. Finish the Patch'n Plug flush with the surface of the concrete.

STEP 4: While slurry coat is still tacky, fill the space behind the Patch'n Plug with a 1" (25 mm) layer of Xypex Concentrate Dry-Pac mixed in the following proportions: one part clean water to six parts Concentrate by volume.

Blend Dry-Pac by trowel for 10 - 15 seconds only (lumps should be present in the mixture). Apply Dry-Pac by gloved hand, and then compress it tightly using a pneumatic packing device or a hammer and block.

STEP 5: While slurry coat is still tacky, fill the space behind the Concentrate Dry-Pac to the surface of the concrete with a good quality non-shrink structural grout.

STEP 6: After the grout has fully set apply a slurry coat of Xypex Concentrate at a coverage rate of 1.5 lb./sq.yd. (0.8 kg/m²) over the grout filled area and to 6" (150 mm) onto the slab away from the space.

STEP 7: Cure by keeping moist by fog spraying periodically with water for two to three days. Open to water contact per Xypex Coatings guidelines. This assembly may be opened to water contact on the Patch'n Plug side immediately.

Note:

If the concrete does not contain Xypex Admix then also apply Xypex Concentrate slurry coat to the Patch'n Plug side per Step 5. Contact Xypex's Technical Services Department or your local Xypex Technical Services Representative regarding appropriate time for exposure to water contact.

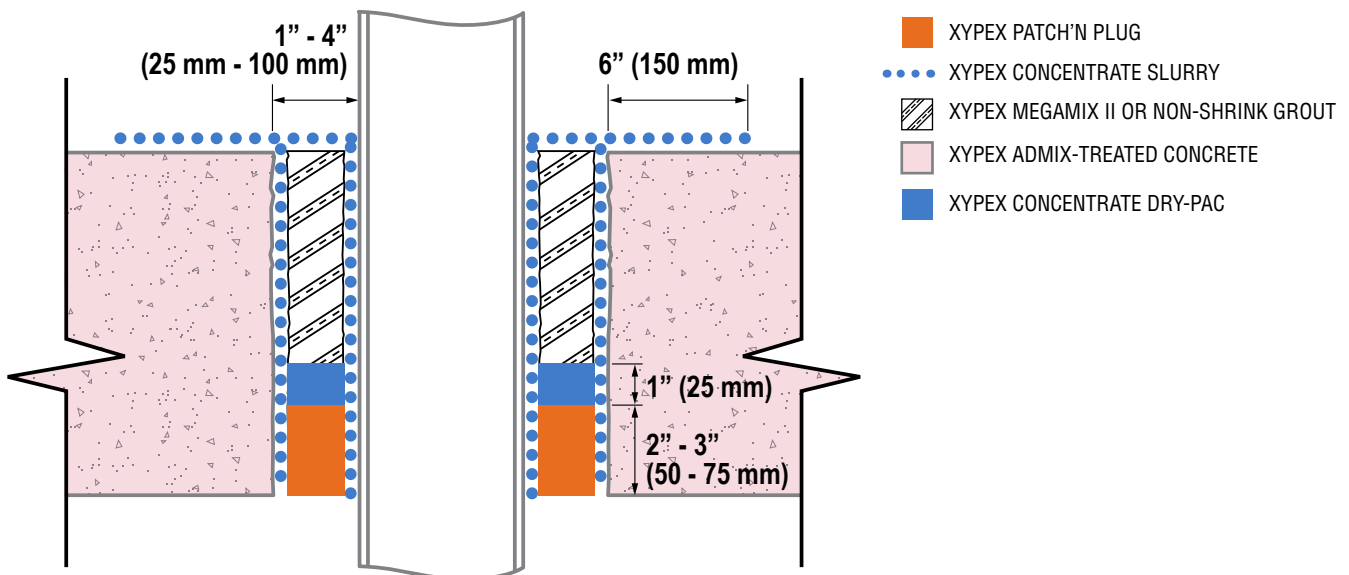

XYPEX WATERPROOFING OF ANNULAR SPACES

Waterproofing of Annular Spaces Surrounding Through Concrete Utilities

For Annular Space Gaps Greater Than 4" (100 mm) Using "Form and Pour" Techniques

STEP 1: Remove all loose materials and thoroughly clean and profile (ICRI CSP-3) the inner surface of the concrete void and the surface of the concrete to 6" (150 mm) around the block out. Clean and roughen all the way through the wall or slab. Lightly sand and clean the surface of the pipe/conduit to provide a profile. Saturate the prepared concrete with water. Allow water to soak into concrete and then remove all surface water.

STEP 2: Apply one slurry coat of Xypex Concentrate at coverage rate of 1.5 lb./sq.yd. (0.8 kg/m²) onto the pipe/conduit, the inner surface of the concrete in the block out and to the surface of the concrete to 6" (150 mm) around the block out. Apply through the full depth of the concrete. Application may be performed by brush or gloved hand.

STEP 3: In conjunction with Step 4 create forms on either side of the block-out to allow a concrete or grout to be poured into and contained in the block-out.

STEP 4: On the wet side of the concrete element, modify the forms around the pipe and the edge of the block out to create "sealing strips" or linear grooves in the finished concrete surface. The sealing strips are to be 1" (25 mm) wide by 1½" (37 mm) deep and are to completely encircle the pipe and the circumference of the block out void.

STEP 5: It is recommended that swelling waterstops be installed as per the diagrams below. Inclusion, type and position of swelling waterstops are at the discretion of the designer. Expanding waterstops may be placed on Xypex after it has dried or before Xypex slurry application. Xypex slurry may only be applied over waterstop if approved by waterstop manufacturer.

STEP 6: Fill the void with a good quality, well consolidated Xypex Admix treated concrete or grout. After the concrete has set strip the forms including the sealing strips.

STEP 7: Clean sealing strips thoroughly. Apply Xypex Concentrate slurry to sealing strips at the rate of 1.5 lb./sq.yd. (0.8 kg/m²). Fill sealing strip with Xypex Concentrate Dry-Pac and pack tightly to create a "sealing strip".

STEP 8: Apply Xypex Concentrate slurry coat at 1.5 lb./sq.yd. (0.8 kg/m²) over entire block out infill and extending to 6" (150 mm) on either side.

STEP 9: Cure by keeping moist by fog spraying periodically with water for two to three days. Open to water contact per Xypex Coatings guidelines.

Note:

When early exposure to water is required:

1. In Step 5, on the wet side, replace the top ¼" - ½" (6 - 12 mm) of Xypex Concentrate Dry-Pac with Xypex Patch'n Plug.
2. On the wet side, eliminate Step 6.

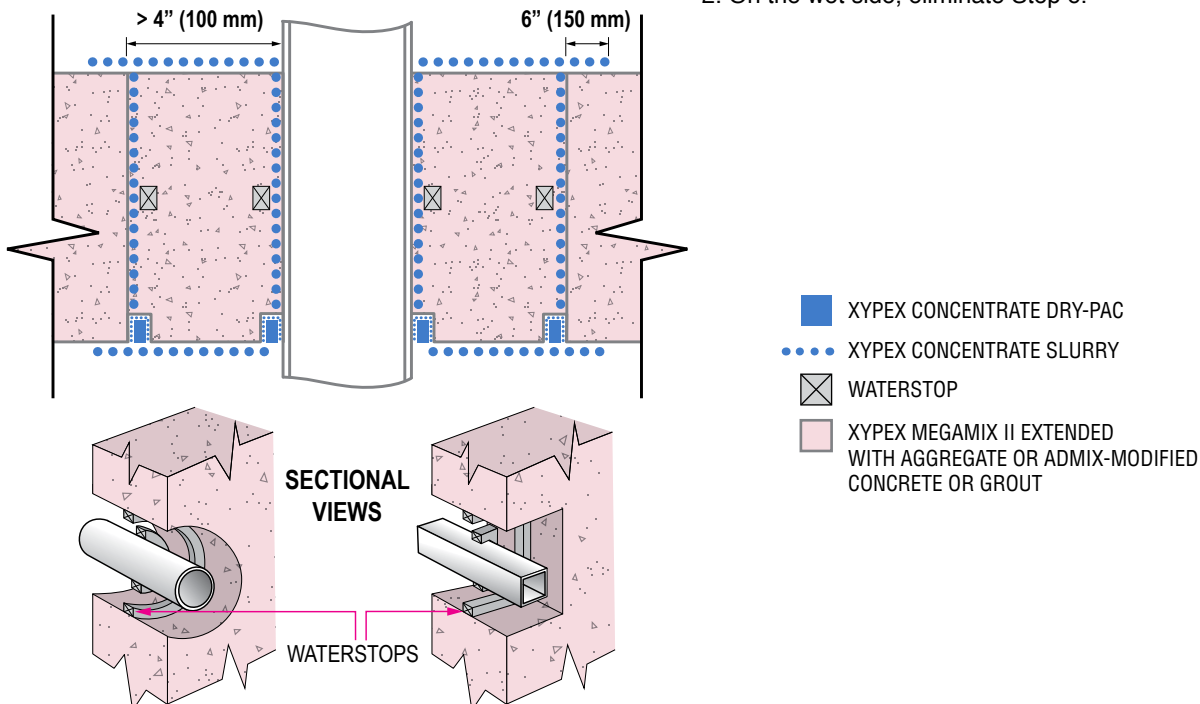

REPAIR OF CRACKS AND FAULTY CONSTRUCTION JOINTS

No Water Flow

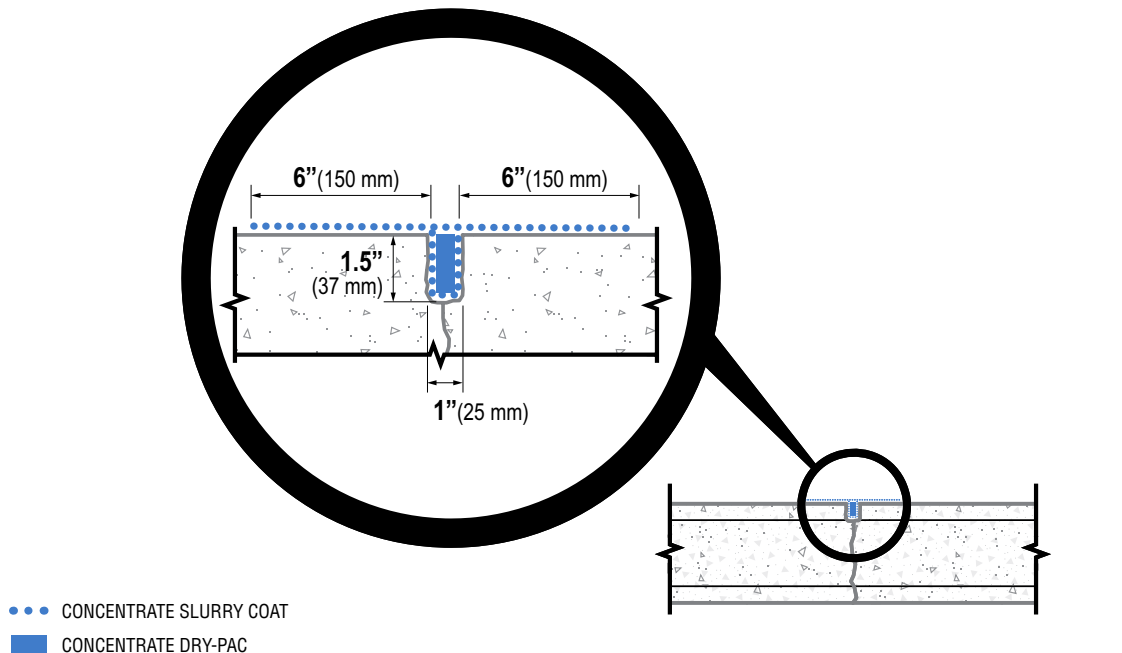

HYDROSTATIC PRESSURE – NO ACTIVE LEAKING WATER

STEP 1: Chip out the crack/joint in a “U” shaped slot as per the drawing shown above. The slot is to be 1” (25 mm) wide and at least 1.5” (37 mm) deep. A “V” shaped slot is not acceptable. The slot may be saw cut instead of chipped but ensure that the slot is dovetailed or otherwise shaped such that there will be mechanical interlock of materials placed into the slot at a later stage.

STEP 2: Remove all loose material within the slot and to 6” (150 mm) on either side of slot. Clean, profile (ICRI CSP-3) and saturate this area with water. Allow water to soak into concrete and then remove all surface water.

STEP 3: Apply one slurry coat of Xypex Concentrate at a coverage of 1.5 lb./sq.yd. (0.8 kg/m²) to the slot and to 6” (150 mm) on either side of the slot. Application may be performed by brush or gloved hand.

STEP 4: While slurry coat is still tacky, fill the slot to the surface with Xypex Concentrate Dry-Pac mixed in the following proportions: one part clean water to six parts Concentrate by volume. Blend Dry-Pac by trowel for 10 - 15 seconds only (lumps should be present in the mixture). Apply Dry-Pac by gloved hand, then compress it tightly using a pneumatic packing device or a hammer and block.

STEP 5: Wet Dry-Pac surface lightly with water, then apply a slurry coat of Xypex Concentrate at a coverage of 1.5 lb./sq.yd. (0.8 kg/m²) over the repaired area and to 6” (150 mm) on either side of the slot.

STEP 6: Cure by keeping moist by fog spraying periodically with water for two to three days. Open to water contact per Xypex Coatings guidelines.

Note:

When early exposure to water is required:

1. In Step 4 – replace the top ¼” - ½” (6 - 12 mm) of Xypex Concentrate Dry-Pac with Xypex Patch’n Plug.
2. Step 5 and Step 6 – eliminate.

REPAIR OF CRACKS AND FAULTY CONSTRUCTION JOINTS

Against a Flow of Water

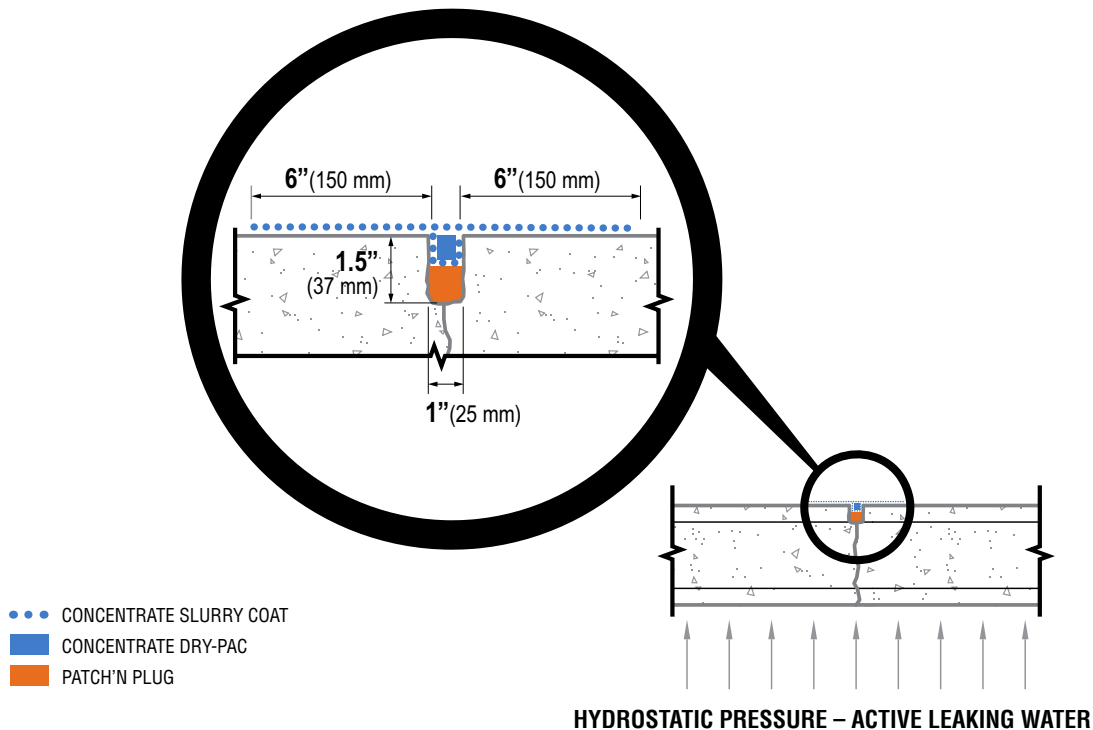

STEP 1: Chip out crack/joint in a “U” shaped slot as per the drawing shown above. The slot is to be 1” (25 mm) wide and at least 1.5” (37 mm) deep. A “V” shaped slot is not acceptable. The slot may be saw cut instead of chipped but ensure that the slot is dovetailed or otherwise shaped such that there will be mechanical interlock of materials placed into the slot at a later stage. Areas with the most water flow should be identified and chipped slightly deeper.

STEP 2: Remove all loose material within the slot and to 6” (150 mm) on either side of slot. Clean, profile (ICRI CSP-3) and saturate this area with water. Allow water to soak in and then remove all surface water.

STEP 3: To stop active water flow apply Xypex Patch’n Plug to half the depth of slot. Patch’n Plug is mixed by adding one part clean water to 3.5 parts Patch’n Plug powder by volume. Patch’n Plug should be applied to full length of crack/joint area.

STEP 4: Apply a slurry coat of Xypex Concentrate at a coverage of 1.5 lb./sq.yd. (0.8 kg/m²) in the slot over the Patch’n Plug and to 6” (150 mm) on either side of the slot. Application may be performed by brush or gloved hand.

STEP 5: While the slurry coat is still tacky, fill the slot to the surface with Xypex Concentrate Dry-Pac. Dry-Pac is mixed by adding one part clean water to six parts Xypex Concentrate powder by volume. Blend Dry-Pac by trowel for 10 - 15 seconds only (lumps should be present in mixture). Apply the Dry-Pac by gloved hand, then compress it tightly by using a pneumatic packing tool or a hammer and block.

STEP 6: Wet the Dry-Pac surface lightly with water, then apply a slurry coat of Xypex Concentrate at a coverage of 1.5 lb./sq.yd. (0.8 kg/m²) over the repaired area and to 6” (150 mm) on either side of slot.

STEP 7: Cure by keeping moist by fog spraying periodically with water for two to three days. Open to water contact per Xypex Coatings guidelines.

Note:

When early exposure to water is required:

1. In Step 5 – replace the top ¼” - ½” (6 - 12 mm) of Xypex Concentrate Dry-Pac with Xypex Patch’n Plug.
2. Step 6 and Step 7 – eliminate.

REPAIR OF CRACKS AND FAULTY CONSTRUCTION JOINTS

Against High Pressure Flow of Water

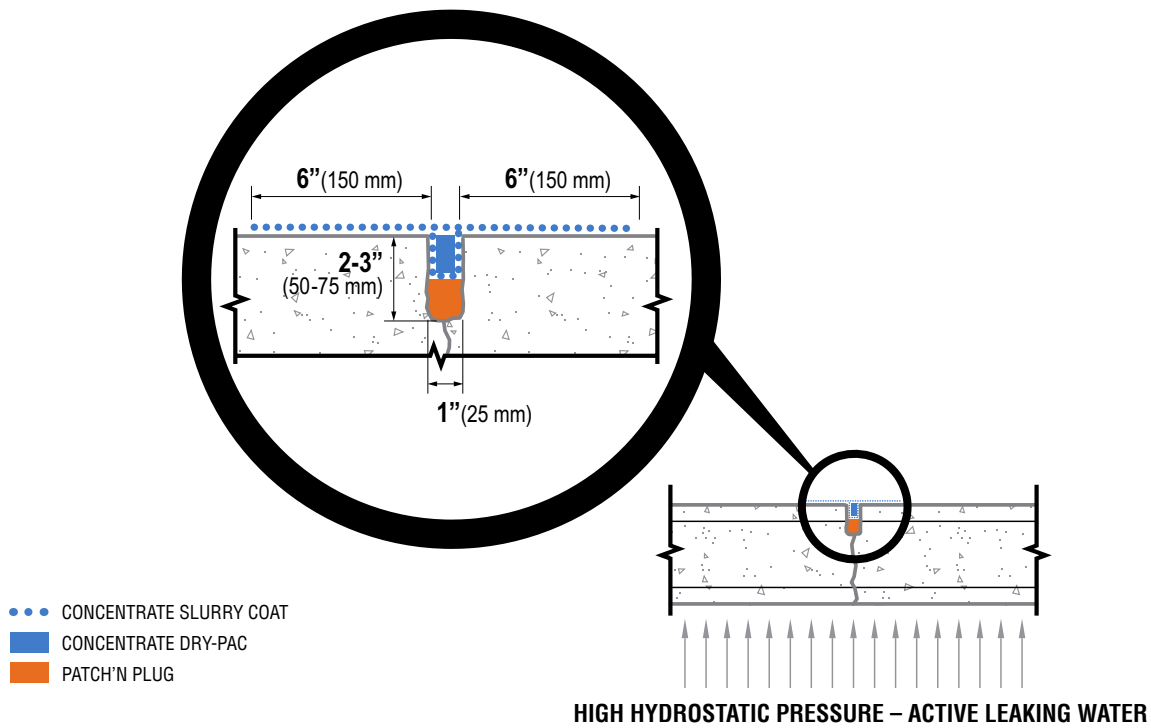

STEP 1: Chip out crack/joint in a “U” shaped slot as per the drawing shown above. The slot is to be 1” (25 mm) wide and 2” - 3” (50 - 75 mm) deep. A “V” shaped slot is not acceptable. The slot may be saw cut instead of chipped but ensure that the slot is dovetailed or otherwise shaped such that there will be mechanical interlock of materials placed into the slot at a later stage.

STEP 2: In the area of greatest water flow, drill a hole or cavity 0.5” (13 mm) deeper into slot to accommodate a bleeder hose. A bleeder hose is a minimum 1.5 foot (0.5 m) length of smooth surfaced, fairly rigid tubing. Its purpose is to relieve the water pressure while the crack/joint is being repaired.

STEP 3: Remove all loose material within the slot and to 6” (150 mm) on either side of slot. Clean, profile (ICRI CSP-3) and saturate this area with water. Allow water to soak in and then remove all surface water.

STEP 4: Place one end of the bleeder hose into the hole or cavity and, while holding the hose steady, apply Xypex Patch’n Plug to the slot around the hose. Approximately two to four applications of Patch’n Plug may be necessary to secure the hose in place and embed the tubing completely up to surface level.

STEP 5: To stop active water flow apply Xypex Patch’n Plug to half the depth of the remaining slot area. Patch’n Plug is mixed by adding one part clean water to 3.5 parts Patch’n Plug powder by volume.

Remove the bleeder hose and pack the hole with Xypex Patch’n Plug to stop all active water flow.

STEP 6: Apply a slurry coat of Xypex Concentrate at a coverage of 1.5 lb./sq.yd. (0.8 kg/m²) in the slot over the Patch’n Plug and to 6” (150 mm) on either side of the slot. Application may be performed by gloved hand or by brush.

STEP 7: While slurry coat is still tacky, fill the slot to the surface with Xypex Concentrate in Dry-Pac consistency. Dry-Pac is mixed by adding one part clean water to six parts Xypex Concentrate powder by volume. Blend by trowel for 10 - 15 seconds only (lumps should be present in mixture). Apply the Dry-Pac by gloved hand, then compress it tightly by using a pneumatic packing tool or a hammer and block.

STEP 8: Wet Dry-Pac surface lightly with water, then apply a slurry coat of Xypex Concentrate at a coverage of 1.5 lb./sq.yd. (0.8 kg/m²) over the repaired area and to 6” (150 mm) on either side of slot.

STEP 9: Cure by keeping moist by fog spraying periodically with water for two to three days. Open to water contact per Xypex Coatings guidelines.

Note:

When early exposure to water is required:

1. In Step 7 – replace the top ¼” - ½” (6 - 12 mm) of Xypex Concentrate Dry-Pac with Xypex Patch’n Plug.
2. Step 8 and Step 9 – eliminate.

REPAIR OF SLAB INTERFACE JOINTS

No Water Flow

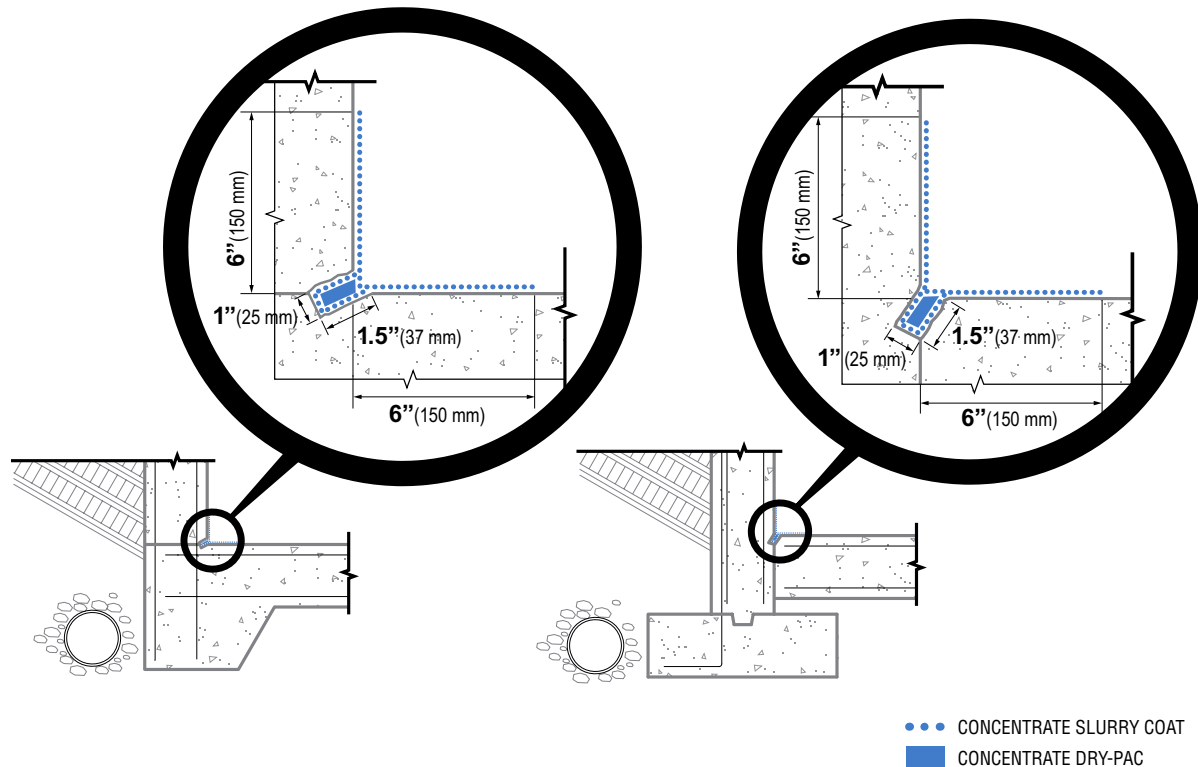

STEP 1: Chip out a “U” shaped slot as per the drawings shown above and depending on the wall to slab interface configuration such that the bottom corner of the slot is centered over the construction joint. The slot is to be 1” (25 mm) wide by at least 1.5” (37 mm) deep. A “V” shaped slot is not acceptable. The slot may be saw cut instead of chipped but ensure that the slot is dovetailed or otherwise shaped such that there will be mechanical interlock of materials placed into the slot at a later stage.

STEP 2: Remove all loose materials within the slot and to 6” (150 mm) on either side of slot. Clean, profile (ICRI CSP-3) and saturate this area with water. Allow water to soak into concrete and then remove all surface water.

STEP 3: Apply one slurry coat of Xypex Concentrate at a coverage of 1.5 lb./sq.yd.² (0.8 kg/m²) in the slot and to 6” (150 mm) up the wall and onto the slab away from the slot. Application may be performed by brush or gloved hand.

STEP 4: While slurry coat is still tacky, fill the slot to the surface with Xypex Concentrate Dry-Pac mixed in the following proportions: one part clean water to six parts Concentrate by volume. Blend Dry-Pac by trowel for 10 - 15 seconds only (lumps should be present in the mixture). Apply Dry-Pac by gloved hand, and then compress it tightly using a pneumatic packing device or a hammer and block.

STEP 5: Wet Dry-Pac surface lightly with water, then apply a slurry coat of Xypex Concentrate at coverage of 1.5 lb./sq.yd. (0.8 kg/m²) over the repaired area and to 6” (150 mm) up the wall and onto the slab away from the slot.

STEP 6: Cure by keeping moist by fog spraying periodically with water for two to three days. Open to water contact per Xypex Coatings guidelines.

Note:

When early exposure to water is required:

1. In Step 4 – replace the top ¼” - ½” (6 - 12 mm) of Xypex Concentrate Dry-Pac with Xypex Patch’n Plug.
2. Step 5 and Step 6 – eliminate.

REPAIR OF SLAB INTERFACE JOINTS

Against a Flow of Water

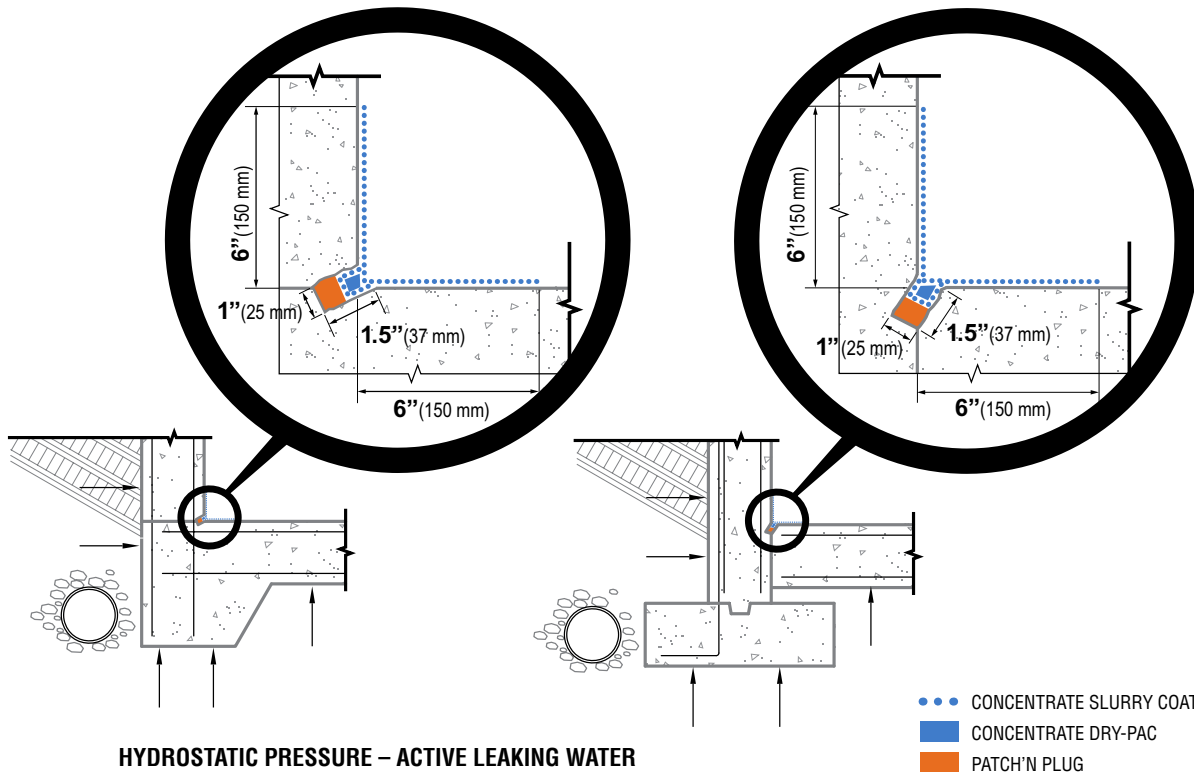

STEP 1: Chip out a “U” shaped slot as per the drawings shown above and depending on the wall to slab interface configuration such that the bottom corner of the slot is centered over the construction joint. The slot is to be 1” (25 mm) wide by at least 1.5” (37 mm) deep. A “V” shaped slot is not acceptable. The slot may be saw cut instead of chipped but ensure that the slot is dovetailed or otherwise shaped such that there will be mechanical interlock of materials placed into the slot at a later stage. Areas with most water flow should be identified and chipped deeper.

STEP 2: Remove all loose materials within the slot and to 6” (150 mm) on either side of slot. Clean, profile (ICRI CSP-3) and saturate this area with water. Allow water to soak into concrete and then remove all surface water.

STEP 3: To stop active water flow apply Xypex Patch’n Plug to half the depth of the slot. Patch’n Plug is mixed by adding one part clean water to 3.5 parts Patch’n Plug powder by volume. Patch’n Plug should be applied to the full length of crack/joint area.

STEP 4: Apply a slurry coat of Xypex Concentrate at a coverage of 1.5 lb./sq.yd. (0.8 kg/m²) in the slot, over the Patch’n Plug, and to 6” (150 mm) up the wall and onto the slab away from the slot. Application may be performed by brush or gloved hand.

STEP 5: While slurry coat is still tacky, fill the slot with Xypex Concentrate Dry-Pac mixed in the following proportions: one part clean water to six parts Concentrate by volume. Blend Dry-Pac by trowel for 10 - 15 seconds only (lumps should be present in the mixture). Apply Dry-Pac by gloved hand, and then compress it tightly using a pneumatic packing device or a hammer and block.

STEP 6: Wet Dry-Pac surface lightly with water, then apply a slurry coat of Xypex Concentrate at coverage of 1.5 lb./sq.yd. (0.8 kg/m²) over the repaired area and to 6” (150 mm) up the wall and onto the slab away from the slot.

STEP 7: Cure by keeping moist by fog spraying periodically with water for two to three days. Open to water contact per Xypex Coatings guidelines.

Note:

When early exposure to water is required:

1. In Step 5 – replace the top ¼” - ½” (6 - 12 mm) of Xypex Concentrate Dry-Pac with Xypex Patch’n Plug.
2. Step 6 and Step 7 – eliminate.

REPAIR OF SLAB INTERFACE JOINTS

Against High Pressure Flow of Water

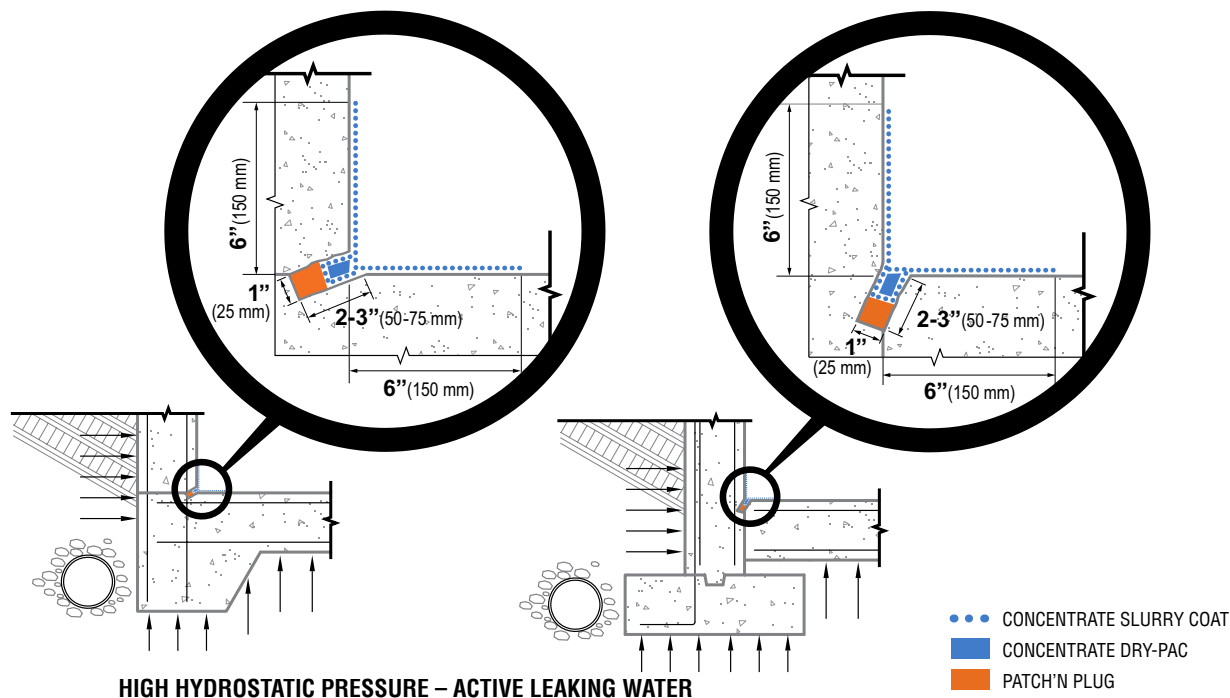

STEP 1: Chip out a “U” shaped slot as per the drawings shown above and depending on the wall to slab interface configuration such that the bottom corner of the slot is centered over the construction joint. The slot is to be 1” (25 mm) wide by at least 2” - 3” (50 - 75 mm) deep. A “V” shaped slot is not acceptable. The slot may be saw cut instead of chipped but ensure that the slot is dovetailed or otherwise shaped such that there will be mechanical interlock of materials placed into the slot at a later stage.

STEP 2: In the area of greatest water flow, drill a hole or cavity 0.5” (13 mm) deeper into slot and over the joint to accommodate a bleeder hose. A bleeder hose is a minimum 1.5 foot (0.5 m) length of smooth surfaced, fairly rigid tubing. Its purpose is to relieve the water pressure while the crack/ joint is being repaired.

STEP 3: Remove all loose materials within the slot and to 6” (150 mm) on either side of slot. Clean, profile (ICRI CSP-3) and saturate this area with water. Allow water to soak into concrete and then remove all surface water.

STEP 4: Place one end of the bleeder hose into the hole or cavity and, while holding the hose steady, apply Xypex Patch’n Plug to the slot around the hose. Approximately two to four applications of Patch’n Plug may be necessary to secure the hose in place and embed the tubing completely up to surface level.

STEP 5: To stop active water flow apply Xypex Patch’n Plug to half the depth of the remaining slot area. Patch’n Plug is mixed by adding one part clean water to 3.5 parts

Patch’n Plug powder by volume. Remove the bleeder hose and pack the hole with Xypex Patch’n Plug to stop all active water flow.

STEP 6: Apply a slurry coat of Xypex Concentrate at a coverage of 1.5 lb./sq.yd. (0.8 kg/m²) in the slot, over the Patch’n Plug, and to 6” (150 mm) up the wall and onto the slab away from the slot. Application may be performed by brush or gloved hand.

STEP 7: While slurry coat is still tacky, fill the slot to the surface with Xypex Concentrate Dry-Pac mixed in the following proportions: one part clean water to six parts Concentrate by volume. Blend Dry-Pac by trowel for 10 - 15 seconds only (lumps should be present in the mixture). Apply Dry-Pac by gloved hand, and then compress it tightly using a pneumatic packing device or a hammer and block.

STEP 8: Wet Dry-Pac surface lightly with water, then apply a slurry coat of Xypex Concentrate at coverage of 1.5 lb./sq.yd. (0.8 kg/m²) over the repaired area and to 6” (150 mm) up the wall and onto the slab away from the slot.

STEP 9: Cure by keeping moist by fog spraying periodically with water for two to three days. Open to water contact per Xypex Coatings guidelines.

Note:

When early exposure to water is required:

1. In Step 7 – replace the top ¼” - ½” (6 - 12 mm) of Xypex Concentrate Dry-Pac with Xypex Patch’n Plug.
2. Step 8 and Step 9 – eliminate.

REPAIR OF DEFECTIVE CONCRETE, ROCK POCKETS OR HONEYCOMBS

For Repair Areas That Are Approximately 6" (150 mm) in Diameter or Less

Honeycombs, rock pockets, spalls and other concrete defects occur in a variety of sizes, shapes and situations which makes it impossible to create a brief work procedure that cover all variables. The following information gives general directions and procedures for repair of standard, small or medium-large sized deficiencies. These procedures should not supersede ACI, ICRI or other recognized authorities' recommendations. The steps outlined here can be modified and adapted to fit most scenarios and provide long term, well bonded concrete repairs.

6" (150 mm) Diameter or Less

STEP 1 – Chip out defective, poorly consolidated or delaminated concrete until sound concrete is encountered.

STEP 2 – If corroded reinforcing steel (rebar) is encountered the defective rebar should be fully exposed by chipping and removing any concrete cover until corrosion free rebar is reached. Remove all corrosion from the exposed rebar and chip all the way around it such that mortar can be placed on all sides of the rebar. If due to corrosion the cross section of the rebar is noticeably reduced advice from a structural engineer on rebar replacement is recommended.

STEP 3 – If there are active water leaks in the excavated area create a void of approximately 1" diameter (25 mm) by about 1" (25 mm) deep at each leak point.

STEP 4 – Delineate the chipped area to as close to a simple square shape as is practical by saw cutting to minimum 3/8" (10 mm) deep or as specified; 3/4" (19 mm) is preferred. If cutting to this depth will damage the rebar then reduce the depth of the cut such that the reinforcing steel is not impacted. Remove the concrete within the designated repair area to create a straight sided, excavated area.

STEP 5 – Remove all loose materials in the excavated area using a 3,500 - 5,000 psi (250 - 350 bar) pressure wash and saturate the area with water. Allow the concrete to absorb the water until it is in a "saturated, surface dry" condition.

STEP 6 – Stop any active leaking by filling the 1" (25 mm) diameter by 1" (25 mm) deep voids at the leak points with Xypex Patch'n Plug.

STEP 7 – Apply a scrub coat of the selected repair mortar to the inside surface of the patch area and, while it is still wet or "green", fill the entire area to the surface with the same mortar. Note that Patch'n Plug is a very rapid setting material so it must be applied immediately after the scrub coat.

STEP 8 – If the void is deeper than 2" (50 mm) it should be filled in layers (lifts) of not more than 2" (50 mm). For mechanical bond of the next layer, provide profile by scoring the surface of the installed mortar with the tip of the trowel. In situations where the repair area requires multiple lifts reinforcing such as wire mesh mechanically attached to the substrate should be considered.

STEP 9 – Apply a coat of Xypex Concentrate slurry at 1.5 lb./sq. yd. (0.8 kg/m²) over the repair area extending to 6" (150 mm) beyond the edge of the patch.

STEP 10 – Cure the repair area by keeping moist by fog spraying periodically with water for two to three days. Open to water contact per Xypex Coatings guidelines.

Note: When early exposure to water is required eliminate Step 9 and Step 10.

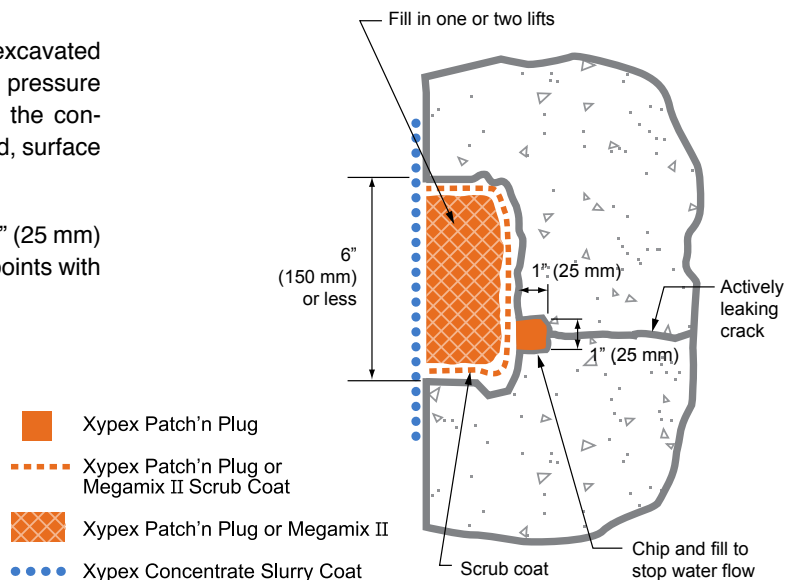

REPAIR OF DEFECTIVE CONCRETE, ROCK POCKETS OR HONEYCOMBS

For Repair Areas That Are Larger than Approximately 6" (150 mm) in Diameter

Larger Than 6" (150 mm) Diameter

STEP 1 – Chip out defective, poorly consolidated or delaminated concrete until sound concrete is encountered.

STEP 2 – If corroded reinforcing steel (rebar) is encountered the defective rebar should be fully exposed by chipping and removing any concrete cover until corrosion free rebar is reached. Remove all corrosion from the exposed rebar and chip around the rebar such that mortar can be placed on all sides of it. If due to corrosion the cross section of the rebar is noticeably reduced advice from a structural engineer on rebar replacement is recommended.

STEP 3 – If there are active water leaks in the excavated area create a void of approximately 1" (25 mm) diameter by about 1" (25 mm) deep at each leak point.

STEP 4 – Delineate the chipped area to as close to a simple square shape as is practical by saw cutting to minimum 3/8" (10 mm) deep or as specified; 3/4" (19 mm) is preferred. If cutting to this depth will damage the rebar then reduce the depth of the cut until rebar is not impacted. Remove the concrete within the designated repair area to the saw cut to create a straight sided excavated area.

STEP 5 – Remove all loose materials in the excavated area using a 3,500 - 5,000 psi (250 - 350 bar) pressure wash and saturate the area with water. Allow the concrete to absorb the water until it is in a "saturated, surface dry" condition.

STEP 6 – Stop any active leaking by filling the 1" (25 mm) diameter by 1" (25 mm) deep voids at the leak points with Xypex Patch'n Plug.

STEP 7 – Apply a scrub coat of Megamix II mortar to the inside surface of the patch area and, while it is still wet or "green", fill the entire area to the surface with Megamix II.

STEP 8 – If the void is deeper than 2" (50 mm) on a vertical or horizontal surface or 1 1/2" (37 mm) on an overhead surface the void should be filled in layers (lifts) of not more than the stated thicknesses. For mechanical bond of the next layer, provide profile by scoring the surface of the installed mortar with the tip of the trowel. In situations where the repair area requires multiple lifts reinforcing such as wire mesh mechanically attached to the substrate should be considered.

STEP 9 – Apply a coat of Xypex Concentrate slurry at 1.5 lb./sq. yd. (0.8 kg/m²) over the repair area and to 6" (150 mm) beyond the edge of the patch.

STEP 10 – Cure by misting with water to keep moist or by covering with a wet curing blanket for two to three days. Open to water contact per Xypex Coatings guidelines.

Note: When early exposure to water is required eliminate Step 9 and Step 10.

- Xypex Patch'n Plug
- Xypex Megamix II Scrub Coat
- Xypex Megamix II
- Xypex Concentrate Slurry Coat

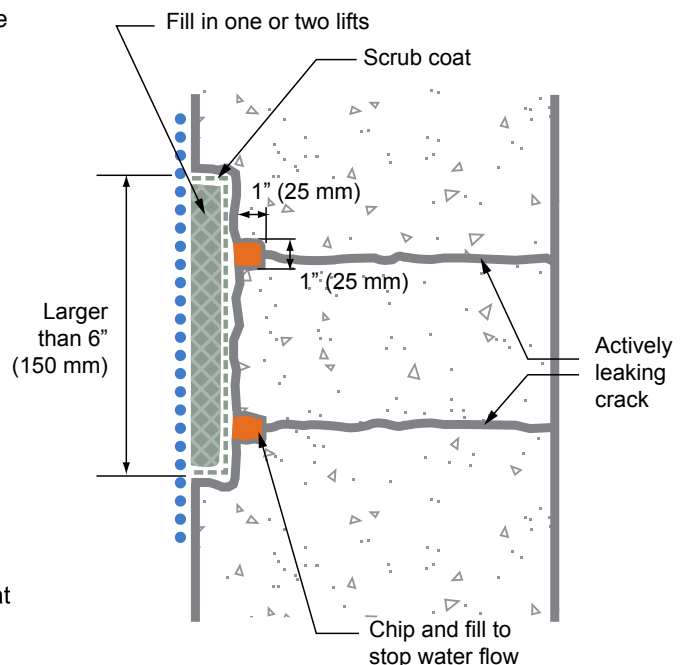

PIPE THROUGH WALL/SLAB REPAIR PROCEDURES

No Water Flow

Through wall / slab details such as pipes or conduit that are completely encased in concrete at the time of the concrete pour are a common part of concrete construction. The following procedures for repair of water leaks at these through concrete utilities are based on circular shapes but may be modified for other shapes as appropriate. These repair methods have been successfully used on many common piping materials including steel, iron, PVC and HDPE.

Note that fluid bearing pipes may vibrate or move due to the hydraulics within the system or thermal expansion and contraction. This type of ongoing movement will interrupt with crystalline based healing. In these cases, contact Xypex's Technical Services Department for assistance.

No Water Flow – Not Actively Leaking

STEP 1: As shown in the drawing below chip out a “U” shaped slot completely circling the through slab pipe or conduit. The slot is to be 1” (25 mm) wide by at least 1.5” (37 mm) deep. A “V” shaped slot is not acceptable. The slot may be saw cut instead of chipped but ensure that the slot is dovetailed or otherwise shaped such that there will be mechanical interlock of materials placed into the slot at a later stage.

STEP 2: Remove all loose materials and thoroughly clean and profile (ICRI CSP-3) the surface of the concrete to 6” (150 mm) around the pipe or conduit. Thoroughly clean the slot and the surface of the pipe or conduit itself. Lightly sand the surface of the pipe or conduit to provide a profile. Saturate the prepared concrete with water. Allow water to soak into concrete and then remove all surface water.

STEP 3: Apply one slurry coat of Xypex Concentrate at a coverage rate of 1.5 lb./sq.yd. (0.8 kg/m²) up the pipe or conduit to the surface of the concrete as well as in the slot and to 6” (150 mm) onto the slab away from the slot. Application may be performed by brush or gloved hand.

STEP 4: While the slurry coat is still tacky, fill the slot to the surface with Xypex Concentrate Dry-Pac mixed in the following proportions: one part clean water to six parts Concentrate by volume. Blend Dry-Pac by trowel for 10 - 15 seconds only (lumps should be present in the mixture). Apply Dry-Pac by gloved hand, and then compress it tightly using a pneumatic packing device or a hammer and block.

STEP 5: Wet Dry-Pac surface lightly with water, then apply a slurry coat of Xypex Concentrate at coverage of 1.5 lb./sq.yd. (0.8 kg/m²) over the repaired area and to 6” (150 mm) onto the slab away from the slot.

STEP 6: Cure by keeping moist by fog spraying periodically with water for two to three days. Open to water contact per Xypex Coatings guidelines.

Note:

When early exposure to water is required:

1. In Step 4, replace the top 1/4” - 1/2” (6 - 12 mm) of Xypex Concentrate Dry-Pac with Xypex Patch'n Plug.
2. Step 5 and Step 6, eliminate.

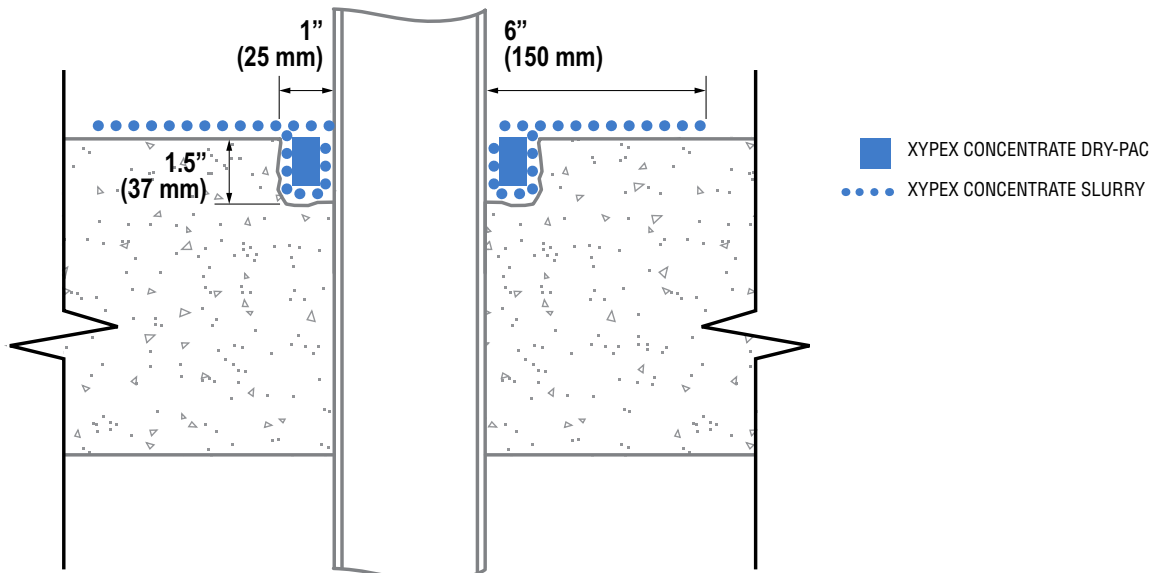

PIPE THROUGH WALL/SLAB REPAIR PROCEDURES

Against a Flow of Water

Active Leaking

STEP 1: As shown in the drawing below chip a “U” shaped slot completely circling the through slab pipe or conduit. The slot is to be 1” (25 mm) wide by at least 1.5” (37 mm) deep. A “V” shaped slot is not acceptable. Areas with most water flow should be identified and chipped deeper. The slot may be saw cut instead of chipped but ensure that the slot is dovetailed or otherwise shaped such that there will be mechanical interlock of materials placed into the slot at a later stage.

STEP 2: Remove all loose materials and thoroughly clean and profile (ICRI CSP-3) the surface of the concrete to 6” (150 mm) around the pipe or conduit. Thoroughly clean the slot and the surface of the pipe or conduit itself. Lightly sand the surface of the pipe or conduit to provide a profile. Saturate the prepared concrete with water. Allow water to soak into concrete and then remove all surface water.

STEP 3: To stop active water flow apply Xypex Patch’n Plug to half the depth of slot. Patch’n Plug is mixed by adding one part clean water to 3.5 parts Patch’n Plug powder by volume. Patch’n Plug should be applied to the full circumference of the chipped slot.

STEP 4: Apply one slurry coat of Xypex Concentrate at a coverage of 1.5 lb./sq.yd. (0.8 kg/m²) over the Patch’n Plug, up the pipe or conduit to the surface of the concrete as well as in the slot and to 6” (150 mm) onto the slab away from the slot. Application may be performed by brush or gloved hand.

STEP 5: While the slurry coat is still tacky, fill the slot to the surface with Xypex Concentrate Dry-Pac mixed in the following proportions: one part clean water to six parts Concentrate by volume. Blend Dry-Pac by trowel for 10 to 15 seconds only (lumps should be present in the mixture). Apply Dry-Pac by gloved hand, and then compress it tightly using a pneumatic packing device or a hammer and block.

STEP 6: Wet Dry-Pac surface lightly with water, then apply a slurry coat of Xypex Concentrate at coverage of 1.5 lb./sq.yd. (0.8 kg/m²) over the repaired area and to 6” (150 mm) onto the slab away from the slot.

STEP 7: Cure by keeping moist by fog spraying periodically with water for two to three days. Open to water contact per Xypex Coatings guidelines.

Note:

When early exposure to water is required:

1. In Step 5, replace the top 1/4” - 1/2” (6 - 12 mm) of Xypex Concentrate Dry-Pac with Xypex Patch’n Plug.
2. Step 6 and Step 7, eliminate.

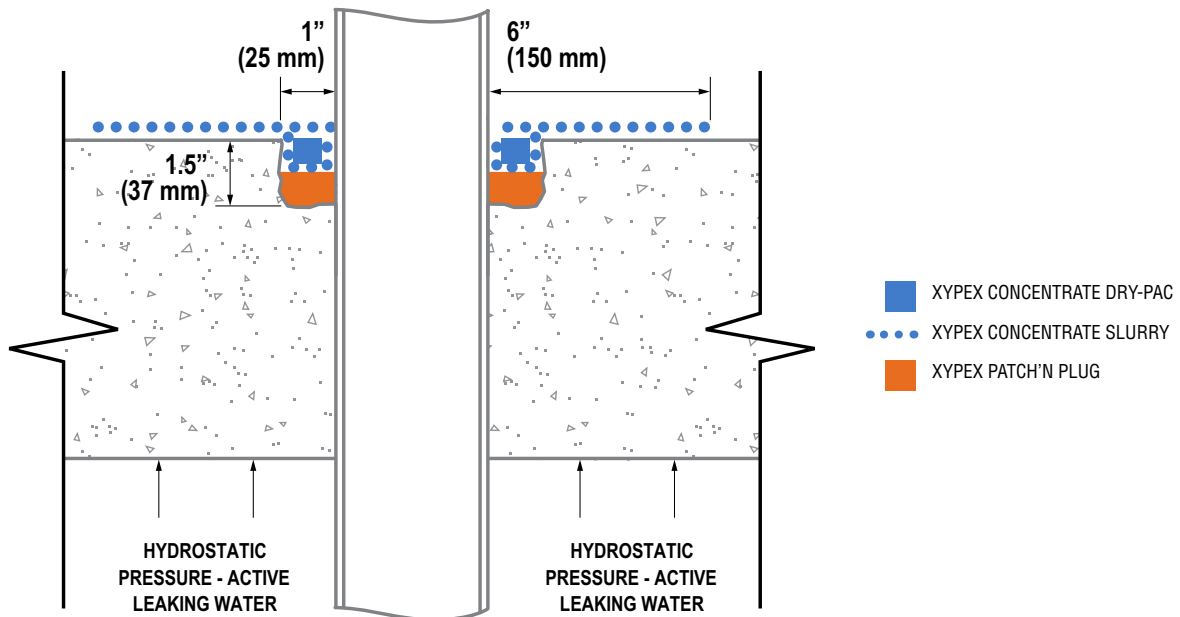

PIPE THROUGH WALL/SLAB REPAIR PROCEDURES

Against High Pressure Flow of Water

Active Leaking

STEP 1: As shown in the drawing below chip a “U” shaped slot completely circling the through slab pipe or conduit. The slot is to be 1” (25 mm) wide by at least 2” - 3” (50 - 75 mm) deep. A “V” shaped slot is not acceptable. The slot may be saw cut instead of chipped but ensure that the slot is dovetailed or otherwise shaped such that there will be mechanical interlock of materials placed into the slot at a later stage.

STEP 2: In area of greatest water flow, drill a hole or chip cavity 0.5” (13 mm) deeper into slot and interfacing with pipe wall to accommodate a bleeder hose. A bleeder hose is a minimum 1.5 foot (0.5 m) length of smooth surfaced, fairly rigid tubing. Its purpose is to relieve the water pressure while joint is being repaired.

STEP 3: Remove all loose materials and thoroughly clean and profile (ICRI CSP-3) the surface of the concrete to 6” (150 mm) around the pipe or conduit. Thoroughly clean the slot and the surface of the pipe or conduit itself. Lightly sand the surface of the pipe or conduit to provide a profile. Saturate the prepared concrete with water. Allow water to soak into concrete and then remove all surface water.

STEP 4: Place one end of the bleeder hose into the hole or cavity and, while holding the hose steady, apply Xypex Patch’n Plug to the slot around the hose. Patch’n Plug is mixed by adding one part clean water to 3.5 parts Patch’n Plug powder by volume. Approximately two to four applications of Patch’n Plug may be necessary to secure the hose in place and embed the tubing completely up to surface level.

STEP 5: To stop active water flow apply Xypex Patch’n Plug to half the depth of remaining slot area. Remove bleeder hose and pack hole with Xypex Patch’n Plug to stop all active water flow.

STEP 6: Apply one slurry coat of Xypex Concentrate at a coverage of 1.5 lb./sq.yd. (0.8 kg/m²) over the Patch’n Plug, up the pipe or conduit to the surface of the concrete as well as in the slot and to 6” (150 mm) onto the slab away from the slot. Application may be performed by brush or gloved hand.

STEP 7: While slurry coat is still tacky, fill slot to surface with Xypex Concentrate Dry-Pac mixed in the following proportions: one part clean water to six parts Concentrate by volume. Blend Dry-Pac by trowel for 10 to 15 seconds only (lumps should be present in the mixture). Apply Dry-Pac by gloved hand, and then compress it tightly using a pneumatic packing device or a hammer and block.

STEP 8: Wet Dry-Pac surface lightly with water, then apply a slurry coat of Xypex Concentrate at coverage of 1.5 lb./sq.yd. (0.8 kg/m²) over the repaired area and to 6” (150 mm) onto the slab away from the slot.

STEP 9: Cure by keeping moist by fog spraying periodically with water for two to three days. Open to water contact per Xypex Coatings guidelines.

Note:

When early exposure to water is required:

1. In Step 7, replace the top 1/4” - 1/2” (6 - 12 mm) of Xypex Concentrate Dry-Pac with Xypex Patch’n Plug.
2. Step 8 and Step 9, eliminate.

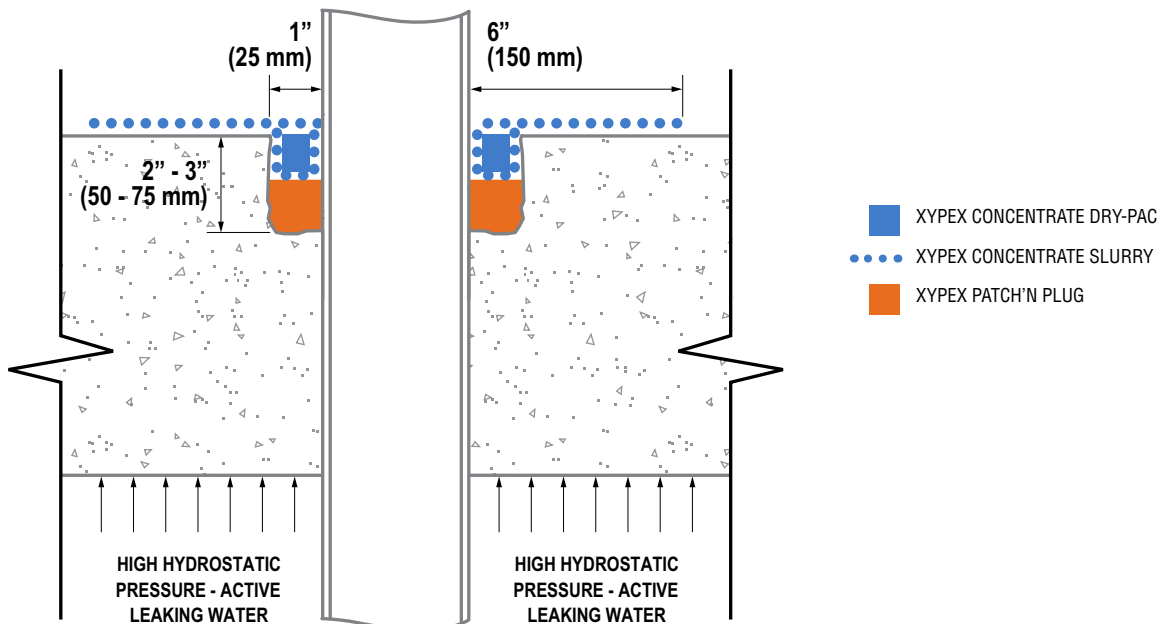

REPAIR OF LEAKING TIE HOLES

No Water Flow

There are several styles of form ties used in construction today. Regardless of the type of form tie or form tie assembly used they all can leave a pathway that can become a leak channel for water or other fluids.

It is impossible to detail all of the different styles of ties used in concrete formwork. The following procedure is based around the typical “Plastic Cone Snap Tie” forming tie system and the cone shaped indent left by it. These procedures can be used as a basis for repair and modified for other styles of form ties.

No Water Flow – Not Actively Leaking

STEP 1: Chip out the void left by the snap tie cone to a “U” shape as per the drawing shown below. The slot is to be approximately 1” (25 mm) in diameter and 1.5” (37 mm) deep. A “V” shaped finished void is not acceptable. Cut back any steel to provide an empty void to the desired depth.

STEP 2: Remove all loose material within the void and to 12” (300 mm) diameter area around the void. Clean, profile (ICRI CSP-3) and saturate this area with water. Allow water to be absorbed into the concrete and then remove all surface water.

STEP 3: Apply one slurry coat of Xypex Concentrate at a coverage of 1.5 lb./sq.yd. (0.8 kg/m²) to the inside of the void and to a 12” (300 mm) diameter area around the chipped void. Application may be performed by brush or gloved hand.

STEP 4: While the slurry coat is still tacky, fill the void to the surface with Xypex Concentrate Dry-Pac mixed in the following proportions: one part clean water to six parts Concentrate by volume. Blend Dry-Pac by trowel for 10 to 15 seconds only (lumps should be present in the mixture). Apply Dry-Pac by gloved hand, then compress it tightly using a pneumatic packing device or a hammer and dowel.

STEP 5: Wet Dry-Pac surface lightly with water, then apply a slurry coat of Xypex Concentrate at a coverage of 1.5 lb./sq.yd. (0.8 kg/m²) over the repaired area and to a 12” (300 mm) diameter area around the filled void.

STEP 6: Cure by keeping moist by fog spraying periodically with water for two to three days. Open to water contact as per Xypex Coatings guidelines.

Note:
When early exposure to water is required:
1. In Step 4, replace the top 1/4” - 1/2” (6 - 12 mm) of Xypex Concentrate Dry-Pac with Xypex Patch’n Plug.
2. Step 5 and Step 6 – eliminate.

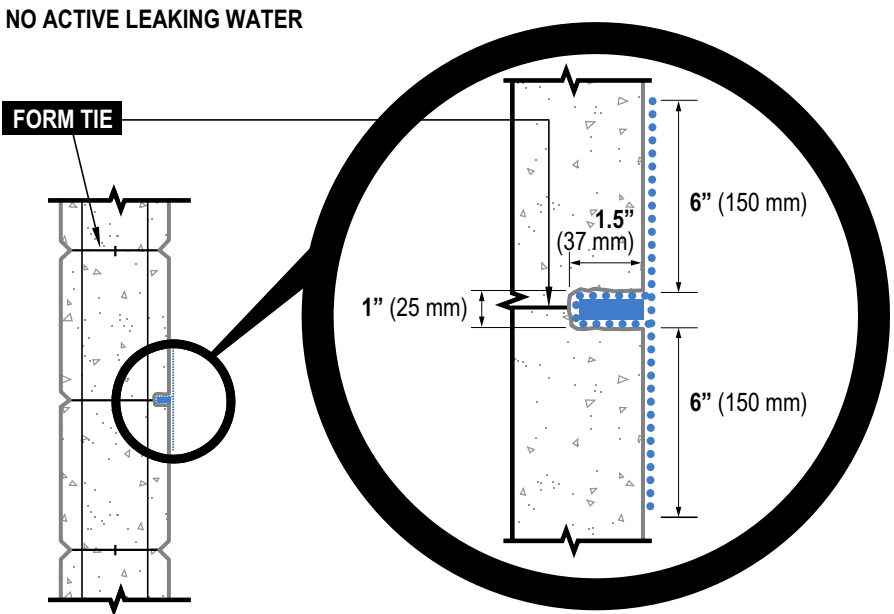

REPAIR OF LEAKING TIE HOLES

Against Flow of Water

Active Leaking

STEP 1: Chip out the void left by the snap tie cone to a “U” shape as per the drawing shown below. The slot is to be approximately 1” (25 mm) in diameter and 1.5” (37 mm) deep. A “V” shaped finished void is not acceptable. Cut back any steel to provide an empty void to the desired depth.

STEP 2: Remove all loose material within the void and and to 12” (300 mm) diameter area around the void. Clean, profile (ICRI CSP-3) and saturate this area with water. Allow water to be absorbed into the concrete and then remove all surface water.

STEP 3: To stop active water flow apply Xypex Patch’n Plug to half the depth of void. Patch’n Plug is mixed by adding one part clean water to 3.5 parts Patch’n Plug powder by volume.

STEP 4: Apply one slurry coat of Xypex Concentrate at a coverage of 1.5 lb./sq.yd. (0.8 kg/m²) to inside of the void over the Patch’n Plug and to a 12” (300 mm) diameter area around the chipped void. Application may be performed by brush or gloved hand.

STEP 5: While the slurry coat is still tacky, fill the void to the surface with Xypex Concentrate Dry-Pac mixed in the following proportions: one part clean water to six parts Concentrate by volume. Blend Dry-Pac by trowel for 10 to 15 seconds only (lumps should be present in the mixture). Apply Dry-Pac by gloved hand, then compress it tightly using a pneumatic packing device or a hammer and dowel.

STEP 6: Wet Dry-Pac surface lightly with water, then apply a slurry coat of Xypex Concentrate at a coverage of 1.5 lb./sq.yd. (0.8 kg/m²) over the repaired area and to a 12” (300 mm) diameter area around the filled void.

STEP 7: Cure by keeping moist by fog spraying periodically with water for two to three days. Open to water contact as per Xypex Coatings guidelines.

Note:

When early exposure to water is required:

1. In Step 4, replace the top 1/4” - 1/2” (6 - 12 mm) of Xypex Concentrate Dry-Pac with Xypex Patch’n Plug.
2. Step 5 and Step 6 – eliminate.

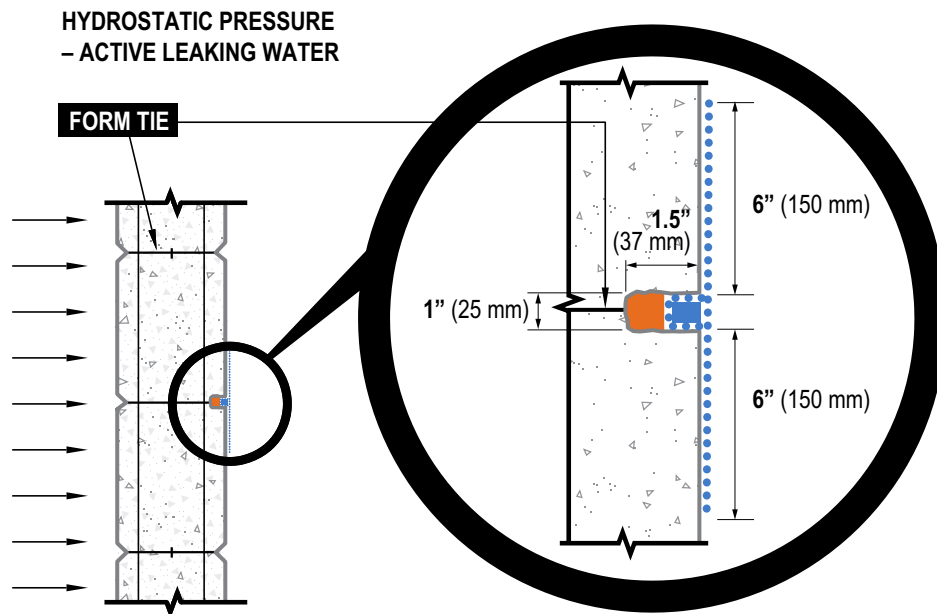

ESTIMATING TABLE & APPLICATION TOOLS

Estimating Table	1
Application Tools	2

ESTIMATING TABLE

Measure	Xypex Concentrate	Xypex Modified	Xypex Patch'n Plug
---------	-------------------	----------------	--------------------

Single Slurry Coat

lb. per sq. yd.	1.50	1.50	n/a
kg per sq. m	0.80	0.80	n/a

One of Two Slurry Coats

lb. per sq. yd.	1.25 - 1.50	1.25 - 1.50	n/a
kg per sq. m	0.65 - 0.80	0.65 - 0.80	n/a

Filling a 0.75" (19 mm) Deep x 1" (25 mm) Wide Slot

lb. per lineal ft.	0.45	n/a	0.50
kg per meter	0.65	n/a	0.75

Filling a 1" Deep (25 mm) x 1" (25 mm) Wide Slot

lb. per lineal ft.	0.55	n/a	0.60
kg per meter	0.85	n/a	0.90

Filling a 1.5" Deep (37 mm) x 1" (25 mm) Wide Slot

lb. per lineal ft.	0.85	n/a	0.95
kg per meter	1.25	n/a	1.40

The above is a guide only. Actual usage may vary according to the project.

APPLICATION TOOLS

Using the proper tools and equipment and wearing protective clothing while working with Xypex products encourages a safer and more effective result.

Protective Clothing and Equipment

- Hard Hat
- Ear Protectors
- Eye Goggles
- Safety Glasses
- Face Shield
- Dust and Mist Mask
- Coveralls
- Knee Protectors
- Work Boots
- Leather Gloves
- Rubber Gloves
- Rain Gear
- Sandblasting Protection Gear

Surface Preparation Equipment

- Sandblaster (Pot and Hose)
- Chipping Hammer and Chisels
- Waterblaster
- Scabblers/Scarifiers
- Crack Chaser
- Compressor

Mixing Equipment

- Mixing Pail
- Electric Drill & Mixing Paddle

Application Equipment

- Semi-Stiff Concrete Brush
- Pattern Pistol (Gun & Hopper)
- Hy-Flex Spray Pump
- Quickspray Carousel Pump
- Water Sprayer
- Packing Gun with Packer Head
- Mechanical Spreader

Miscellaneous Equipment

- Extension Cords
- Flood Lights
- Industrial Vacuum (Wet/Dry Capability)
- Ladders and Scaffolding
- Maintenance Tools and Equipment
- Power Trowel
- Water Hoses and Spray Nozzles
- Ropes
- Space Heating Units
- Tarpaulins
- Ventilation Fans

For more detailed information, please contact Xypex's Technical Services Department at 604-273-5265 / toll-free 800-961-4477 or your local Xypex Technical Services Representative.

FREQUENTLY ASKED QUESTIONS

General FAQ	1
Coating FAQ	3
Additive FAQ	5
Dry Shake FAQ	6

GENERAL FAQ

What makes Xypex unique?

Xypex becomes an integral part of the concrete mass itself. Traditional barrier products, on the other hand, rely solely on their performance at the surface of the concrete and are therefore subject to deterioration caused by exposure to the environment, hydrostatic pressure, puncturing, delamination, chemical erosion, and damage during backfilling. Xypex was developed to eliminate these very issues. The Xypex formula is based on the natural characteristics of concrete – the fact that concrete is both porous and chemical in nature. With moisture as the catalyst, Xypex’s proprietary chemicals react with the products of cement hydration to form a non-soluble complex within the pores, voids and capillary tracts of the concrete mass. From this inside position, Xypex renders the concrete impenetrable by water and other liquids from any direction, eliminates the problems normally associated with traditional barriers and, in the process, enhances the quality and durability of the concrete structure.

How long does Xypex last?

The Xypex treatment, unlike most other systems, becomes a permanent part of the concrete matrix. Its unique dendritic crystalline growth will not deteriorate under normal conditions, and the crystalline process will reactivate whenever water is present.

What are some typical Xypex applications?

Typical Xypex applications include reservoirs, sewage and water treatment tanks, secondary containment structures, tunnels, underground vaults, manholes, concrete pipe, foundations, pools, parking structures and below grade construction.

Can Xypex be used against extreme hydrostatic pressure?

Yes. Because Xypex is not dependent upon adhesion to the concrete surface and, instead, becomes an integral part of the concrete mass, it is capable of resisting extreme hydrostatic pressure from either side (positive or negative) of the concrete. Independent laboratory testing in accordance with U.S. Army Corps of Engineers CRD C-48 “Permeability of Concrete” showed that Xypex-treated concrete withstood up to 405 feet (123.4 m) of head pressure (175 psi/1.2 MPa), the limit of the testing apparatus.

Does Xypex protect reinforcing steel?

Yes. By preventing the intrusion of water, salt water, sewage, and most chemicals, Xypex helps protect reinforcing steel against oxidation and deterioration.

Does Xypex protect concrete against freeze/thaw damage?

Yes. By blocking the intrusion of water into concrete, Xypex helps protect the concrete from the damaging effect of repeated freeze/thaw cycles.

Does Xypex have any adverse effect on concrete?

No. The Xypex crystalline formation becomes a part of the concrete matrix itself and has no deleterious effect on the concrete. In fact, independent laboratory testing has shown that under most conditions Xypex enhances the strength and durability of the concrete structure.

Is Xypex toxic?

No. Xypex contains no volatile organic carriers (VOCs) and can be applied safely in enclosed surroundings. Xypex is approved by numerous health and water authorities around the world for use on structures that contain potable water or foodstuffs. A few of these agencies are:

- NSF International
- Swiss Federal Department of Health
- Japan Food Research Laboratories
- United Kingdom (DWI) Drinking Water Inspectorate
- Australian Water Quality Centre
- Singapore Institute of Standards and Industrial Research
- France Research Centre for the Control of Water
- Czech Republic Health Institute & Centre for Drinking Water

GENERAL FAQ

In what forms is the Xypex Crystalline Technology available?

The Xypex Crystalline Technology is available in three forms:

- As a Coating System (Xypex Concentrate & Modified) for new or existing structures
- As a Concrete Additive (Xypex Admix C-Series) to be added at time of concrete batching
- As a Dry Shake Material (Xypex Concentrate DS-1 & DS-2) for fresh horizontal surfaces

These three options will prove an asset to the value-engineering process and to the flexibility of the construction schedule.

How is Xypex different from other products?

The Xypex crystalline system for concrete waterproofing and protection is substantially different from traditional barrier products (membranes, cementitious coatings, etc):

1. Xypex creates a crystalline structure deep within the pores and capillary tracts of the concrete mass to prevent the penetration of water and aggressive chemicals. In contrast, barrier type products function only at the surface of concrete.
2. Because Xypex is not dependent on surface adhesion to achieve its waterproofing effect, it is resistant to extreme hydrostatic pressure.
3. Xypex will seal static hairline cracks up to 0.4 mm (1/64").
4. Xypex is not subject to the deterioration problems encountered by membranes.
5. Xypex is designed to be permanent and reactivates whenever water is present.

Is Xypex used to waterproof cracks, faulty joints and other defects in concrete?

Yes. Xypex has a specific repair system that utilizes its unique crystalline waterproofing technology to stop water flow through cracks, faulty construction joints and other defects. In the case of expansion joints or chronic moving cracks, a flexible sealant is recommended.

COATING FAQ

When Applied as a Coating:

Can the Xypex coating be applied to the negative side of a structure?

Yes. Although applied as a coating, Xypex is not relying on its surface bonding capability to achieve its water-proofing effect. By means of diffusion, the reactive chemicals in the Xypex coating migrate through the capillary tracts within the concrete to become an integral part of the concrete mass. Therefore, the Xypex coating can be applied to either the positive (water side) or negative side even against strong hydrostatic pressure.

Is there a preference when choosing between the positive or negative side?

Generally, it is recommended that the Xypex coating be applied to the positive side (water side), if accessible, so as to ensure maximum benefit. Therefore, new construction specifications almost always call for the use of the Xypex coating on the positive side (water side). If, however, the positive side is not accessible e.g. tunneling projects or rehabilitation of existing structures, the Xypex coating will be specified for use on the negative side against the hydrostatic pressure.

Can the Xypex coating be applied while the concrete is wet?

Yes. In fact, the concrete must be wet or moist before applying the Xypex slurry coat. Xypex requires moisture to generate the crystalline growth in concrete. The presence of moisture is also necessary to ensure proper bonding of the slurry coat to the concrete substrate.

Is the Xypex coating suitable for use on surfaces other than concrete?

Xypex is totally compatible with the chemistry of concrete, whether cast-in-place, precast or shotcrete. It is not suitable for application to cut-limestone, clay brick, wood, metals, asphalt or other non-concrete building materials.

How deep does the Xypex crystalline formation penetrate the concrete?

The Xypex chemical reactions that initially take place at the concrete surface will continue deep into the concrete structure. Various factors affect the rate and depth of crystallization within the concrete. Some of these factors

are: number of Xypex coats, mix design of the concrete, density, porosity, cement content, exposure to moisture and temperature. Independent testing measured the depth of Xypex crystalline penetration into a cast-in-place concrete block at 30 cm (approximately 12 inches). The test concrete sample was coated on the top surface with Xypex Concentrate and left outside the research laboratory in ambient temperatures for 12 months.

How resistant is the Xypex coating to aggressive chemicals?

Based on independent testing according to ASTM C 267 "Chemical Resistance of Mortars", the Xypex coating is not affected by a wide range of aggressive chemicals including mild acids, solvents, chlorides and caustic materials. Because Xypex is pH specific (not chemical specific) it will protect concrete from any chemical whose pH range is 3.0 to 11.0 constant contact, or 2.0 to 12.0 periodic contact.

Is the Xypex coating affected by temperature, humidity, ultraviolet and oxygen levels?

When applied according to specifications, Xypex performs at 100% efficiency within -25°F to +265°F (-32°C to +130°C) constant temperatures or within -301°F to +2786°F (-185°C to +1530°C) periodic temperatures. Humidity, ultraviolet and the oxygen level (oxidation) have no effect on a Xypex coating.

What is the appearance of a Xypex coating?

A Xypex coating normally produces a grey-colored, cementitious surface. However, Xypex "White" is also available.

Can paint and other finishing materials be applied over a Xypex coating?

Yes. In most circumstances paint, epoxy coatings, cement parge coats, plaster and stucco can be applied over a Xypex coating. For further information concerning the interface of the Xypex coating with paint and other finishing materials, consult with a Xypex Technical Services Representative.

COATING FAQ**How is the Xypex coating system different from other cementitious coatings?**

Most cementitious coatings are simply surface treatments and are totally dependent on maintaining a proper bond to the concrete surface. Such coatings usually incorporate a latex modifier which makes the coating less permeable and acts as a bonding agent for better adhesion to the surface. They are surface treatments only, and have the added disadvantage of limiting breathability of the concrete. They do not form crystals within the concrete substrate (contrary to what is sometimes represented) and are not effective when applied against hydrostatic pressure.

What are the installation advantages to using a Xypex coating system instead of membranes?

The crystalline nature of the Xypex waterproofing system provides many installation advantages over traditional barrier products:

1. Xypex does not require a dry surface; in fact, a wet surface is necessary.
2. Xypex does not require dry weather to be applied.
3. Xypex does not require costly surface priming or leveling prior to application.
4. Xypex cannot puncture, tear or come apart at the seams.
5. Xypex does not require protection during backfilling or during placement of steel, wire mesh or other materials.
6. Xypex can be applied on either side of a concrete surface – the negative or the positive side.
7. Xypex does not require sealing, lapping and finishing of seams at corners, edges or between membranes.
8. Xypex is less costly to apply than most other methods.

ADDITIVE FAQ

When Applied as a Concrete Additive:

What is the difference between the various additives in Xypex's Admix C-Series?

All variations of the Admix C-Series contain the same amount of reactive chemicals at their prescribed dosage rates and provide the same waterproofing and durability performance characteristics. Xypex Admix C-Series is available in regular or no-fines grades (NF). Xypex Admix C-500/C-500 NF is formulated to have minimal or no effect on setting time. Xypex Admix C-1000/C-1000 NF is formulated for concrete mix designs where a normal or mildly delayed set is desired. Xypex Admix C-2000/C-2000 NF is designed for warmer climates and projects where a slower hydration rate is typically required.

When is Xypex Admix introduced into the concrete mix?

Xypex Admix is added to the concrete mix at time of batching. The sequence for the addition of the Admix powder will vary depending on the type of batching operation and equipment, e.g. ready-mix plant (dry batch operation), ready-mix plant (central mix operation), or precast batch plant.

What is the recommended dosage rate for Xypex Admix?

Xypex Admix is added to the concrete mix at a dosage rate within the range of 2 - 3% by weight of the cement content. Where the "No Fines" (NF) grade is utilized, the equivalent dosage rate is 1 - 1.5%. For assistance in determining the appropriate dosage rate for a particular project, consult Xypex technical literature or contact a Xypex Technical Services Representative.

Is Xypex Admix available in soluble bags?

Yes. In North America, Australia, S.E. Asia, Europe, the Middle East and Africa, Xypex Admix is now available in soluble bags. Xypex Admix C-500/C-500 NF and C-1000/C-1000 NF are available in a variety of conveniently sized soluble bags to meet specific batching requirements. They enhance quality control and eliminate dust during dosing.

Can Xypex Admix be used in concrete containing other additives such as a water-reducer, plasticizer or air-entrainment agent?

Yes. Xypex Admix has been used successfully in concrete mix designs containing a variety of other admixtures. However, it should be noted that the use of retarding

admixtures at recommended dosage rates may cause further extension of set time when used with Xypex Admix. Consult with a Xypex Technical Services Representative for assistance in determining which version of Xypex Admix to use and the appropriate dosage rate.

Can Xypex Admix be used in concrete containing fly ash, micro-silica or slag cement?

Yes. Xypex Admix is very effective when used in modern mix designs that incorporate cementitious replacement materials i.e. fly ash, silica fume and blast furnace slag. The reactions that take place to form the crystalline structure are very complex. During the cement hydration process, Xypex's active chemicals not only react with calcium hydroxide and unhydrated cement particles but also with various metal oxides and mineral salts, regardless of the cement type used. Consult with a Xypex Technical Services Representative to determine dosage rates for such blended cement mix designs.

How are the set time and compressive strength of concrete affected by the addition of Xypex Admix?

The set time of concrete is affected by the chemical and physical composition of ingredients, temperature of the concrete and climatic conditions. Extension of set time may occur when using Xypex Admix. The amount of extended set will depend upon the concrete mix design and the dosage rate of the Admix. Concrete containing Xypex Admix may develop higher ultimate strengths than untreated concrete. Trial mixes should be carried out under project conditions to determine set time and strength of the concrete.

Are there any limitations that affect the performance of Xypex Admix?

Use of Xypex Admix requires a minimum of 10% Portland cement content. Of course, optimum effectiveness will be dependent on a number of factors such as thickness of the concrete, Portland cement content, whether there is sufficient reinforcing steel for strength and crack control, quality of placing and finishing practices, sealing of construction joints etc. Typically, Xypex requires a minimum concrete thickness of 5 cm (2") and a minimum design strength of 20 MPa (3,000 psi).

DRY SHAKE FAQ

When Applied as a Dry Shake:

When are Xypex dry shake products (Xypex Concentrate DS-1 or DS-2) normally used?

The Xypex “dry shake” products are designed specifically for use on horizontal concrete slabs during the new construction phase. By incorporating the dry Xypex powder into the top surface of freshly poured concrete, the active chemicals in Xypex use the bleed water and moisture in the concrete as a migrating medium to generate the crystalline formation throughout the concrete substrate.

What is the advantage of using the dry shake method?

Because Xypex “dry shake” products become an integral part of the concrete surface, problems often associated with coatings (e.g. scaling, dusting, flaking, delamination) are eliminated. This can be very beneficial for slabs that require a hard surface due to traffic and abrasion. The dry shake method may also provide cost savings, especially on large projects, by reducing material and labor costs and by helping to speed up the construction schedule.

How is Xypex DS-2 different from Xypex Concentrate DS-1?

Xypex DS-2 has been specially designed for dry shake applications on horizontal concrete slabs where greater resistance to abrasion is required. Xypex DS-2 contains the same crystalline waterproofing properties as DS-1, however it also includes a synthetic aggregate hardener which has been crushed and graded to particle sizes suitable for concrete floors.

Section	Page
What is CSI Format?	1
Crystalline Waterproofing Coating	2
Crystalline Waterproofing Additive	9
Crystalline Waterproofing Dry Shake	15

WHAT IS CSI FORMAT?

This section of the Xypex Specification and Application Manual utilizes the Section Format™ of the Construction Specifications Institute (CSI) Manual of Practice®. Section Format provides a uniform approach to organizing specification text by establishing a structure consisting of three primary parts: General, Products, and Execution. Text within each of the three parts is divided into articles and subordinate paragraphs and subparagraphs. The article titles serve as a checklist for consideration by the specifier. These titles are optional and selections should be based on appropriateness for the specific situation being addressed. CSI is a USA based professional society for the specifications community. Xypex Chemical Corporation is aware that other organizations with different but equally valid specification formats are available and utilized by specifiers in different parts of the world.

Contact Xypex representatives for alternative formats that incorporate local requirements and standards.

CRYSTALLINE WATERPROOFING COATING

SECTION 071616

PART 1 – GENERAL

1.01 Summary

- A. **Section Includes:** Furnishing of all labor, materials, services and equipment necessary for the supply and installation of cementitious crystalline waterproofing to concrete substrates, above-grade or below-grade, on either dry or wet side of substrates, as indicated on drawings and as specified herein.
- B. **Related Sections:**
1. Section 031000 - Concrete Forming and Accessories
 2. Section 079000 - Joint Protection
 3. Section 099000 - Paints and Coatings

1.02 References

- A. **Applicable Standards:** The following standards are referenced herein.
1. American Society for Testing and Materials (ASTM)
 2. Army Corps of Engineers (CRD)
 3. American National Standards Institute (ANSI)
 4. NSF International
 5. European Standards (EN)
 6. RILEM
 7. Drinking Water Inspectorate (DWI)

1.03 System Description

- A. **Cementitious Crystalline Waterproofing:** Concrete waterproofing and protection system shall be of the crystalline type that is a blend of Portland cement, fine treated silica sand and active proprietary chemicals. When mixed with water and applied as a cementitious coating, the active chemicals diffuse into the concrete and cause a catalytic reaction which generates a non-soluble crystalline structure within the pores and capillary tracts of concrete. This crystalline system causes the concrete to become sealed against the penetration of liquids from any direction, and protects the concrete from deterioration due to harsh environmental conditions. The system is used for above or below-grade walls and slabs, including liquid retaining structures and where enhanced chemical resistance is required.

1.04 System Performance Requirements

- A. **Testing Requirements:** Crystalline waterproofing system shall have been tested in accordance with the following standards and conditions, and the testing results shall meet or exceed the performance requirements as specified herein.
- B. **Independent Laboratory:** Testing shall have been performed by an accredited independent laboratory meeting the requirements of ASTM E 329 or other applicable international standard for certification of testing laboratories. Testing laboratory shall have obtained all control and treated concrete samples.
- C. **Crystalline Penetration:** Crystallizing capability of waterproofing material shall be evidenced by independent SEM (Scanning Electron Microscope) photographs. Crystal growth 12 inches (30 cm) from the surface of the coating shall be evident with 1000x magnification 1 year after application of the coating and exposure of the sample to normal weathering.
- D. **Permeability:** Independent testing shall be performed according to U.S. Army Corps of Engineers CRD C48 "Permeability of Concrete". Concrete samples shall have design strength of 2000 psi (14 MPa) and thickness of 2 inches (50 mm). Treated samples shall have two coats of crystalline waterproofing applied per manufacturer's directions. Samples to be pressure tested to 175 psi (405 foot head of water) or 1.2 MPa (123.4 m head of water). Control samples shall leak and treated samples, after crystalline growth has occurred, shall exhibit no measurable leakage.
- E. **Permeability - Negative Side Application:** Independent testing shall be performed according to EN 12390-8 or other recognized direct pressure test. Concrete samples shall have a design strength of 25 MPa (3600 psi). Treated samples shall be exposed to water pressure on the side opposite to the crystalline coating. Coated samples shall exhibit a greater than 90% reduction in depth of water penetration as compared to the control samples.
- F. **Chemical Resistance:** Independent testing shall be performed according to ASTM C 267 "Chemical Resistance of Mortars" and ASTM C 39 "Compressive Strength of Cylindrical Concrete Specimens". Concrete samples (treated and untreated) shall have design strength of 4000 psi (27.6 MPa). Treated samples shall have two coats of crystalline waterproofing applied per manufacturer's directions. Untreated and

CRYSTALLINE WATERPROOFING COATING

treated specimens must be immersed for a minimum of 84 days in following chemical solutions: hydrochloric acid (3.5 pH), brake fluid, transformer oil, ethylene glycol, toluene, caustic soda. Treated specimens shall exhibit no detrimental effects after exposure, and shall have an average of 17% increase in compressive strength versus untreated control specimens.

- G. **Acid Resistance:** Independent testing shall be performed to determine “Sulfuric Acid Resistance of Concrete Specimens”. Treated concrete samples shall be tested against untreated control samples. All samples shall be immersed in 5% sulfuric acid and weighed weekly for 10 weeks. Untreated samples shall exhibit at least 8 times more mass loss than treated samples.
- H. **Carbonation Resistance Testing:** Independent testing shall be performed according to RILEM CPC-18 or other recognized accelerated carbonation test. Concrete samples shall have a 0.5 w/cm ratio or be approximately 30 MPa (4500 psi) in strength. Coated samples shall have crystalline coating applied one day after casting and all samples to be cured for 7 days prior to carbonation. After 91 days exposure to CO₂ the coated samples shall show a 35% or greater reduction in carbonation depth as compared to the control samples.
- I. **Potable Water Approval:** Waterproof material shall have a current, valid approval certificate from NSF (NSF 61), DWI, or other recognized certification agency.

1.05 Submittals

- A. **General:** Submit listed submittals in accordance with conditions of the Contract and with Division 1 Submittal Procedures Section.
- B. **Product Data:** Submit product data, including manufacturer’s specifications, installation instructions, and general recommendations for waterproofing applications.
- C. **Test Reports:** Submit for acceptance, complete test reports from approved independent testing laboratories certifying that waterproofing system conforms to performance characteristics and testing requirements specified herein.
- D. **Manufacturer’s Certification:** Provide document signed by manufacturer or manufacturer’s representative certifying that the materials to be installed comply with the requirements of this specification.

- E. **Manufacturer’s Field Report:** Provide copy of report from manufacturer’s representative confirming that the surfaces to which waterproofing material is to be applied are in a condition suitable to receive same.

1.06 Quality Assurance

- A. **Manufacturer Qualifications:** Manufacturer shall be ISO 9001 registered, and shall have no less than 10 years experience in manufacturing the cementitious crystalline waterproofing materials for the required work. Manufacturer must be capable of providing field service representation during construction phase. Manufacturers who cannot provide ongoing field support or the performance test data specified herein will not be considered for the project.
- B. **Applicator:** Waterproofing applicator shall be experienced in the installation of cementitious crystalline waterproofing materials as demonstrated by previous successful installations, and shall be approved by the manufacturer in writing.
- C. **Pre-Installation Conference:** Prior to installation of waterproofing, conduct meeting with waterproofing applicator, Architect/Engineer, owner’s representative, and waterproofing manufacturer’s representative to verify and review the following:
 1. Project requirements for waterproofing as set out in Contract Document.
 2. Manufacturer’s product data including application instructions.
 3. Substrate conditions, and procedures for substrate preparation and waterproofing installation.
- D. **Technical Consultation:** The waterproofing manufacturer’s representative shall provide technical consultation on waterproofing application and provide on-site support as needed.

1.07 Delivery, Storage and Handling

- A. **Ordering:** Comply with manufacturer’s ordering instructions and lead time requirements to avoid construction delays.
- B. **Delivery:** Deliver packaged waterproofing materials to project site in original undamaged containers, with manufacturer’s labels and seals intact.

CRYSTALLINE WATERPROOFING COATING

- C. **Storage:** Store waterproofing materials in dry, enclosed location, at a minimum temperature of 45°F (7°C).

1.08 Project Conditions

- A. **Compliance:** Comply with manufacturer’s product data regarding condition of substrate to receive waterproofing, weather conditions before and during installation, and protection of the installed waterproofing system.

1.09 Warranty

- A. **Manufacturer’s Warranty:** Manufacturer shall provide standard product warranty executed by authorized company official.
- B. **Applicator’s Warranty:** Applicator shall warrant the waterproofing installation against defects caused by faulty workmanship or materials for a period of typically (specify term) years from Date of Substantial Completion. The warranty will cover the surfaces treated and will bind the applicator to repair, at his expense, any and all leaks through the treated surfaces which are not due to structural weaknesses or other causes beyond applicator’s control such as fire, earthquake, tornado and hurricane. The warranty shall read as follows:
 1. **Warranty:** The applicator warrants that, upon completion of the work, surfaces treated with cementitious crystalline waterproofing will be and will remain free from water leakage resulting from defective workmanship or materials for a period of (specify term) years from Date of Substantial Completion. In the event that water leakage occurs within the warranty period from such causes, the applicator shall, at his sole expense, repair, replace or otherwise correct such defective workmanship or materials. Applicator shall not be liable for consequential damages and applicator’s liability shall be limited to repair, replacement or correcting of defective workmanship or materials. Applicator shall have no responsibility with respect to water leakage or other defects caused by structural failure or movement of the structure, or any other causes beyond Applicator’s control.

PART 2 – PRODUCTS

2.01 Materials

A. **Acceptable Manufacturer:**

Xypex Chemical Corporation
 13731 Mayfield Place
 Richmond, B.C., Canada V6V 2G9
 Tel: 800 961.4477 or 604 273.5265
 Fax: 604 270.0451 E-mail: info@xypex.com
 Website: www.xypex.com

Note: Acceptable manufacturers include all licensed manufacturing operations of Xypex Chemical Corporation.

B. **Proprietary Products:** Xypex crystalline waterproofing materials as follows:

1. Xypex Concentrate
2. Xypex Modified
3. Xypex Patch’n Plug

Note: Supplemental specifications are available for Xypex Admix series (admixture) and Xypex Concentrate DS-1/DS-2 (dry shake).

C. **Substitutions:** No substitutions permitted.

D. **Source Quality:** Obtain all proprietary crystalline waterproofing products from a single manufacturer.

2.02 Mixes

A. **General:** Mix waterproofing material by volume with clean, potable water. Mix waterproofing material in quantities that can be applied within 20 to 30 minutes from time of mixing. As mixture thickens, stir frequently, but do not add additional water. Do not mix bonding agents or admixtures with crystalline waterproofing materials.

B. **Brush Application Mix:** Measure dry powder and place in mixing container. Measure water and mix into the dry powder with a paddle on a slow speed electric drill (250 RPM) or other type mixer which is acceptable to manufacturer. Mixing proportions shall be as follows:

Coverage	Proportions (by Volume)
1.5 lb./sq.yd. (0.8 kg/m ²)	5 powder to 2 water
2.0 lb./sq.yd. (1.0 kg/m ²)	3 powder to 1 water

CRYSTALLINE WATERPROOFING COATING

- C. **Spray Application Mix:** Mixing shall be same as specified for brush application except that mixture shall be thinner. Use following proportions as a guide only. Adjust proportions to match type of spray equipment and pressures used. Mixing proportions shall be as follows:

Coverage	Proportions (by Volume)
1.5 lb./sq.yd. (0.8 kg/m ²)	5 powder to 3 water

- D. **Dry-Pac Mix:** Using a trowel, mix 1 part clean water with 6 parts Xypex Concentrate powder for 10 to 15 seconds. It is acceptable that lumps may be present in mixture. Mix only as much as can be applied in 15 minutes.

PART 3 – EXECUTION

3.01 Examination

- A. **Site Visit:** Prior to waterproofing installation, arrange visit to project site with waterproofing manufacturer's representative. Representative shall inspect and certify that concrete surfaces are in acceptable condition to receive waterproofing treatment.
- B. **Verification of Substrates:** Verify that concrete surfaces are sound and clean, and that form release agents and materials used to cure the concrete are fully removed.
- C. **Examination for Defects:** Examine surfaces to be waterproofed defects such as honeycombing, rock pockets, faulty construction joints and cracks. Such defects to be repaired in accordance to manufacturer's product data and 3.02 below.

3.02 Preparation

- A. **Surface Preparation:** Smooth surfaces (e.g. where steel forms are used) or surfaces covered with form oil or other contaminants shall be cleaned, water-blasted, lightly sand-blasted, or acid etched as necessary to provide a clean absorbent surface. The surface must also have an open capillary system to provide "tooth and suction" for the Xypex treatment. A minimum of CSP-3 per the International Concrete Repair Institute Concrete Surface Profile Chips or other equivalent standard is required. Surfaces to be acid-etched shall be saturated with water before application of the acid. After acid etching flush concrete thoroughly with clean water. Horizontal surfaces shall have a rough wood float or broom finish. Where

a smooth trowel finish is required on horizontal surface, crystalline waterproofing material shall be applied by dry shake method at time of concrete finishing in accordance with manufacturer's product data.

- B. **Repair of Defects:** Concrete defects shall be repaired in accordance with manufacturer's technical literature including relevant Method Statements (Section 1.3, p. 19-26). Procedures are generally as follows:

1. Cracks and Faulty Construction Joints:
 - a. Chip out cracks, faulty construction joints and other defects to a depth of 1.5 inches (37 mm) and a width of one inch (25 mm). A "V" shaped slot is not acceptable. The slot may be saw cut instead of chipped but ensure that the slot is dovetailed or otherwise shaped such that there will be mechanical interlock of materials placed into the slot at a later stage.
 - b. Clean slot of debris and dust. Soak area with water and remove excess surface water. Apply a slurry coat of Xypex Concentrate at the rate of 1.5 lb./sq.yd. (0.8 kg/m²) to the slot.
 - c. While slurry coat is still tacky, fill cavity with Dry-Pac. Compress tightly into cavity using pneumatic packer or block and hammer.
 - d. This step may be omitted if the area filled with Dry-Pac will be subsequently covered with Xypex coating. Wet Dry-Pac surface lightly with water, then apply a slurry coat of Xypex Concentrate at a coverage rate of 1.5 - 2 lb./sq.yd. (0.8 - 1 kg/m²) over the repaired area to a 6" (150 mm) on either side of slot.

2. Rock Pockets, Honeycombing or Other Defective Concrete: All areas of poor concrete consolidation (honeycomb or rock pockets) shall be repaired.

Note: Where there is active water-flow see Method Statements or contact Xypex Technical Services Representative for assistance.

- C. **Wetting Concrete:** Xypex requires a saturated surface dry (SSD) substrate. Concrete surfaces must be thoroughly saturated with clean water prior to the application so as to aid the proper diffusion of the Xypex chemistry and to ensure the growth of the crystalline formation deep within the pores of the concrete. Remove excess water before the applica-

CRYSTALLINE WATERPROOFING COATING

tion such that there is no glistening water on the surface. If concrete dries out before application, it must be re-wetted.

3.03 Application

- A. **Construction Joints:** In addition to specified waterstops, apply one coat of Xypex Concentrate slurry at a rate of 2 lb./sq.yd. (1 kg/m²) to joint surfaces between concrete pours. Moisten surfaces prior to slurry application. Apply slurry and keep moist for 12 hours then allow slurry to set or dry. Where joint surfaces are not accessible prior to pouring new concrete, contact Xypex Technical Services Representative for assistance.

NOTE: Inclusion, type and position of waterstops are at the discretion of the designer. Expanding waterstops may be placed on Xypex after it has dried or before Xypex slurry application. Xypex slurry may only be applied over waterstop if approved by waterstop manufacturer.

- B. **Sealing Strips:** Where hydrostatic conditions exist, sealing strips shall also be applied at construction joints by filling grooves that are created along the joints. Dimensions of the grooves shall be 1 inch (25 mm) wide and 1.5 inches (37 mm) deep. If grooves are not pre-formed then chip grooves to those dimensions. Fill the grooves as follows:

1. Apply slurry coat of Xypex Concentrate slurry to slot in accordance with manufacturer's instructions or recommendations.
2. While slurry coat is still tacky, fill slot with Xypex Concentrate Dry-Pac.
3. Compact tightly using pneumatic packer or hammer and block.
4. This step may be omitted if the area filled with Dry-Pac will be subsequently covered with Xypex coating. Wet Dry-Pac surface lightly with water, then apply a slurry coat of Xypex Concentrate at a coverage rate of 1.5 - 2 lb./sq.yd. (0.8 - 1 kg/m²) over sealing strip and extending to 6" (150 mm) on either side.

Note: For further information, see Xypex Schematic Drawings for standard construction joint details.

- C. **Form Tie Holes:** Form tie holes shall be waterproofed in accordance with manufacturer's technical literature

including relevant Method Statements (Section 1.3, p. 30-31). Procedures are generally as follows:

1. Prepare the tie hole to create a straight sided void with a profile of at least ICRI CSP-3. For through element ties holes such as those created by taper ties the prepared void is to be at least 5" (125 mm) deep. For cone ties the void is to be to the bottom of the cone.
2. Clean and profile the area to a 12 inch (300 mm) diameter around the tie hole to an ICRI CSP-3 profile.
3. For through-element tie holes create a solid plug of material at the bottom of the profiled hole using Xypex Patch'n Plug leaving at least 4" (100 mm) of empty tie hole from the top of the plug to the surface of the concrete element.
4. Apply a coat of Xypex Concentrate slurry at a rate of 1.5 lb./sq.yd. (0.8 kg/m²) to the inside of the tie hole and to a 12" (300 mm) diameter area around the hole.
5. Fill and compact the tie hole with Xypex Concentrate Dry-Pac.
6. This step may be omitted if the area filled with Dry-Pac will be subsequently covered with Xypex coating. Wet Dry-Pac surface lightly with water, then apply a slurry coat of Xypex Concentrate at a coverage rate of 1.5 - 2 lb./sq.yd. (0.8 - 1 kg/m²) over the repaired area to a 12" (300 mm) diameter area around the filled void.

- D. **Surface Application:** After repairs, surface preparation, treatment of construction joints and sealing strip placement have been completed in accordance with manufacturer's product data and as specified herein, apply Xypex treatment to concrete surfaces with semi-stiff bristle brush, push broom (for large horizontal surfaces), or suitable spray equipment. The Xypex coating must be uniformly applied and should be just under 1/16" (1.25 mm) thick.

Application rates and locations shall be as indicated in the drawings and in accordance with manufacturer's product data. When brushing, work slurry well into surface of the concrete, filling surface pores and hairline cracks. When spraying, hold nozzle close enough to ensure that slurry is forced into pores and hairline cracks.

CRYSTALLINE WATERPROOFING COATING

1. **First Coat** (of one or two coat application): Apply Xypex Concentrate slurry coat to locations indicated on drawings in accordance with manufacturer's product data.
2. **Second Coat** (of two coat application): Where indicated on drawings or as required by manufacturer's product data, apply Xypex Modified or Xypex Concentrate slurry coat after the first coat of Xypex Concentrate has reached an initial set but while it is still "green" (less than 48 hours). Curing by misting the coating with water should be done between coats. Ensure first coat is in SSD condition before application of the second coat.

Note: Prior to the installation, it is recommended that a test section be completed under anticipated ambient and project conditions to demonstrate acceptable bond.

- E. **Sandwich (Topping) Application:** When treated structural slabs are to receive a concrete or other topping, place the topping while waterproofing material is still "green" (less than 48 hours) but after it has reached an initial set. The preferred time frame is 12 to 24 hours after the installation of Xypex coating. Curing by misting the coating with water should be done between application of coating and installation of concrete overlay. Ensure coating is in SSD condition prior to placement of concrete.

3.04 Curing

- A. **General:** Begin curing as soon as Xypex coating has hardened sufficiently so as not to be damaged by a fine spray. Cure Xypex treatment with a mist fog spray of clean water three times a day for 2 to 3 days, or cover treated surfaces with damp burlap for the prescribed period. In warm climates, more than three sprayings per day may be necessary to prevent excessive drying of coating.
- B. **Air Circulation:** Do not lay plastic sheeting directly on the waterproofing coating as air contact is required for proper curing. If poor air circulation exists in treated areas, it may be necessary to provide fans or blown air to aid in curing of waterproofing treatment.
- C. **Holding Structures:** For water holding structures such as swimming pools, reservoirs, water treatment tanks and wet wells, cure Xypex treatment for three days and then allow treatment to set for 12 days

before filling. For structures holding hot or corrosive liquids, cure waterproofing treatment for three days and allow to set for 18 days before filling.

- D. **Protection:** During the curing period, protect treated surfaces from damage by wind, sun, rain, puddling of water and temperatures below 36°F (2°C). If plastic sheeting is used for protection, it must be raised off of the waterproofing coating to allow sufficient air circulation.

3.05 Interface With Other Materials

- A. **Backfilling:** Do not backfill for 36 hours after application. If backfill takes place within seven days after application, then backfill material shall be moist so as not to draw moisture from waterproof coating.
- B. **Paint, Epoxy or Similar Coatings:** Do not apply paint or other coatings until waterproofing treatment has cured and set for a minimum of 21 days. Light abrasive blasting or washing the Xypex surface with a 3 - 5% acid solution followed by a rigorous rinse with clean water is recommended before applying the coating. Be sure to flush all acid off the surface. Alternately, removal of the Xypex coating by high pressure washing or abrasive blasting following full curing is acceptable. Consult epoxy and paint manufacturer for additional coating instructions and restrictions.
- C. **Grout, Cement Parge Coat, Plaster or Stucco:** It is recommended that any other cementitious system be applied over the Xypex coating after the Xypex has completely set but while it is still "green" (12 to 48 hours). The 12 to 24 hour window is considered ideal. Contact your Xypex Technical Services Representative regarding surface preparation and other procedures for installations of other materials onto Xypex coatings older than 48 hours. Alternately, removal of the Xypex coating by high pressure washing or abrasive blasting following full curing is acceptable. Use of a polymer additive to help improve bond in the over coating mortar mix should be considered.
- D. **Responsibility to Ensure Compatibility:** Xypex Chemical Corporation makes no representations or warranties regarding compatibility of Xypex treatment with coatings, plasters, stuccos, tiles or other surface-applied materials. It shall be the responsibility of the installer of the surface-applied material that is to be applied over the Xypex waterproofing treatment, to

CRYSTALLINE WATERPROOFING COATING

take whatever measures are necessary, including testing, to ensure acceptance by or adhesion to the waterproofing treatment.

Note: Prior to the installation, it is recommended that a test section be completed under anticipated ambient and project conditions to demonstrate acceptable bond.

pedestrian traffic for 3 days and vehicular traffic for 7 days. If coatings will be exposed to ongoing vehicular traffic or other abrasive environments consult Xypex Technical Services.

END OF SECTION 071616

3.06 Field Quality Control

- A. **Observation:** Do not conceal installed waterproofing system before it has been observed by Architect/Engineer, waterproofing manufacturer’s representative and other designated entities.
- B. **Testing for Tanks and Foundation Works:**
 - 1. Testing: Fill tanks or, for foundation works, shut off dewatering system as soon as practical so that the structure shall be exposed to it’s normal service conditions. Examine for leaks.
 - 2. Monitoring:
 - a. Actively leaking cracks and joints shall be left to self-heal for as long as practical. Depending on job site and ambient conditions crack healing can be expected to take several days to weeks.
 - b. Any crack or joints that do not heal in the allowable time frame shall be repaired by the general contractor.
 - c. Moving cracks shall be repaired using polyurethane injection or other appropriate method.
 - 3. Repair: Use Xypex repair procedures to seal any static crack or joint that does not self-heal. See Method Statements (Section 1.3, p. 19-24) or contact Xypex Technical Services Representative for appropriate repair procedures.

Note: Lower temperatures will extend the times for crystalline development.

3.07 Cleaning and Protection

- A. **Cleaning:** Clean spillage and soiling from adjacent surfaces using appropriate cleaning agents and procedures.
- B. **Protection:** Take measures to protect completed Xypex coating until the coating is hard enough to not be damaged. In normal conditions protect from

CRYSTALLINE WATERPROOFING ADDITIVE

SECTION 033000

PART 1 – GENERAL

1.01 Summary

- A. **Section Includes:** Furnishing of all labor, materials, services and equipment necessary for the supply and installation of crystalline waterproofing additive to concrete as indicated on the drawings and as specified herein.
- B. **Related Sections:**
1. Section 031000 - Concrete Forming
 2. Section 032000 - Concrete Reinforcement
 3. Section 031516 - Concrete Construction Joints
 4. Section 033713 - Shotcrete
 5. Section 034000 - Precast Concrete
 6. Section 071616 - Crystalline Coatings
 7. Section 079000 - Joint Protection

1.02 References

- A. **Applicable Standards:** The following standards are referenced herein.
1. American Society for Testing and Materials (ASTM)
 2. Army Corps of Engineers (CRD)
 3. American Concrete Institute (ACI)
 4. American National Standards Institute (ANSI)
 5. NSF International
 6. European Standards (EN)
 7. Drinking Water Inspectorate (DWI)

1.03 System Description

- A. **Crystalline Waterproofing Additive:** Concrete waterproofing and protection system shall be of the crystalline type that chemically controls and permanently fixes a non-soluble crystalline structure within the pores and capillary tracts of the concrete. This crystalline system causes the concrete to become sealed against the penetration of liquids from any direction, and protects the concrete from deterioration due to harsh environmental conditions. The system is used for above or below-grade walls and slabs, including liquid retaining structures and where enhanced chemical resistance is required.

1.04 System Performance Requirements

- A. **Testing Requirements:** Crystalline waterproofing system shall have been tested in accordance with

the following standards and conditions, and the testing results shall meet or exceed the performance requirements as specified herein.

- B. **Independent Laboratory:** Testing shall have been performed by an accredited independent laboratory meeting the requirements of ASTM E 329 or other applicable international standard for certification of testing laboratories. Testing laboratory shall have obtained all control and treated concrete samples.
- C. **Crystalline Formation:** Crystallizing capability of waterproofing system shall be evidenced by independent SEM (Scanning Electron Microscope) photographs showing crystalline formations within the concrete matrix.
- D. **Permeability 1:** Independent testing shall be performed according to a U.S. Army Corps of Engineers CRD-C48 (Mod.) "Permeability of Concrete". Concrete samples shall be pressure tested to 150 psi (350 foot head of water) or 1.05 MPa (106 m head of water). After 5 days the untreated samples shall leak and the treated samples shall exhibit no measurable leakage.
- E. **Permeability 2:** Independent testing shall be performed according to EN 12390-8. Treated samples shall be exposed to water with a pressure of 0.5 MPa for 72 hours. Treated samples must exhibit a reduction in permeability coefficient of at least 80% when compared to control concrete. Control samples must have a depth of penetration of at least 50 mm.
- F. **Sulfuric Acid Resistance:** Independent testing shall be performed to determine "Sulfuric Acid Resistance of Concrete Specimens". Treated concrete samples dosed at 3% (Admix Regular Grade) shall be tested against untreated control samples. All samples shall be immersed in 7% sulfuric acid and weighed daily until a control sample reaches a mass loss of 50%. On final weighing the percentage mass loss of the treated samples shall be significantly lower than the control samples.
- G. **Sulfate Resistance:** Independent testing shall be performed to determine "Sulfate Resistance of Concrete Specimens" treated with integral crystalline admixture. Treated and untreated samples shall be immersed in a concentrated sulfate solution for at least 4 months. On final weighing the percentage mass loss of the treated samples shall be significantly lower than the control samples.

CRYSTALLINE WATERPROOFING ADDITIVE

- H. **Compressive Strength:** Concrete samples containing the crystalline waterproofing additive shall be tested against an untreated control sample of the same mix. At 28 days, the treated samples shall exhibit equal or increased compressive strength over the control sample.
- I. **Potable Water Approval:** Waterproof material shall have a current, valid approval certificate from NSF (NSF 61), DWI, or other recognized certification agency.

1.05 Submittals

- A. **General:** Submit listed submittals in accordance with conditions of the Contract and with Division 1 Submittal Procedures Section.
- B. **Product Data:** Submit product data, including manufacturer's specifications, installation instructions, and general recommendations for waterproofing applications.
- C. **Test Reports:** Submit, for acceptance, complete test reports from approved independent testing laboratories certifying that waterproofing system conforms to performance characteristics and testing requirements specified herein.
- D. **Manufacturer's Certification:** Provide document signed by manufacturer or manufacturer's representative certifying that the materials to be installed comply with the requirements of this specification.

1.06 Quality Assurance

- A. **Manufacturer Qualifications:** Manufacturer to be ISO 9001 registered, and to have no less than 10 years experience in manufacturing the crystalline waterproofing additive for the required work. Manufacturer must be capable of providing field service representation during construction phase. Manufacturers who cannot provide ongoing field support or who cannot provide the performance test data specified herein will not be considered for the project.
- B. **Installer:** Ready-mix supplier and/or installer of crystalline waterproofing additive shall be approved by the manufacturer or manufacturer's representative in writing.
- C. **Pre-Installation Conference:** Prior to installation of waterproofing system, conduct meeting with Architect/Engineer, owner's representative, concrete supplier,

concrete placer and waterproofing manufacturer's representative to verify and review the following:

1. Project requirements for waterproofing as set out in Contract Documents.
 2. Manufacturer's product data including mixing and installation instructions.
- D. **Technical Consultation:** The waterproofing manufacturer's representative shall provide technical consultation on waterproofing applications and shall provide on-site support as needed.

1.07 Delivery, Storage and Handling

- A. **Ordering:** Comply with manufacturer's ordering instructions and lead time requirements to avoid construction delays.
- B. **Delivery:** Deliver packaged waterproofing materials to project site in original undamaged containers, with manufacturer's labels and seals intact.
- C. **Storage:** Store waterproofing materials in dry, enclosed location, at a minimum temperature of 45°F (7°C).

1.08 Warranty

- A. **Project Warranty:** Refer to conditions of the Contract for project warranty provisions.
- B. **Manufacturer's Warranty:** Manufacturer shall provide standard product warranty executed by authorized company official.

PART 2 – PRODUCTS

2.01 Materials

- A. **Acceptable Manufacturer:**
 Xypex Chemical Corporation
 13731 Mayfield Place
 Richmond, B.C., Canada V6V 2G9
 Tel: 800 961.4477 or 604 273.5265
 Fax: 604 270.0451 E-mail: info@xypex.com
 Website: www.xypex.com

Note: Acceptable manufacturers include all licensed manufacturing operations of Xypex Chemical Corporation.

CRYSTALLINE WATERPROOFING ADDITIVE

- B. **Proprietary Products:** Xypex crystalline waterproofing materials as follows:
 1. Xypex Admix C-500 / C-500 NF
 2. Xypex Admix C-1000 / C-1000 NF
 3. Xypex Admix C-2000 / C-2000 NF
- C. **Substitutions:** No substitutions permitted.
- D. **Source Quality:** Obtain all proprietary crystalline waterproofing products from a single manufacturer.

2.02 Dosage

- A. **General:** Xypex Admix must be added to concrete mix at time of batching.
- B. **Dosage Rate:** Under normal conditions, the crystalline waterproofing powder shall be added to the concrete mix at the following rates:

Xypex Admix C-500
2 - 3% by weight of cement content

Xypex Admix C-1000
2 - 3% by weight of cement content

Xypex Admix C-2000
2% by weight of cement content

For Xypex Admix NF Series dosages are
1% - 1.5% by weight of cement content

Note: For enhanced chemical protection or for meeting specific project requirements or where the concrete mix design contains higher than 25% type F fly ash content or includes a portland cement/slag cement/type C fly ash blend, consult with manufacturer or its authorized representative to determine appropriate dosage rates.

PART 3 – EXECUTION

3.01 Manufacturer's Instructions

- A. **Compliance:** Comply with manufacturer's product data regarding installation, including technical bulletins, product catalogue, installation instructions and product packaging labels.

3.02 Project Conditions

- A. **Crack Control:** All reinforcement shall be in accordance with applicable standards. Concrete elements shall be designed and constructed to minimize and control cracking.

- B. **Setting Time and Strength:** Some delay of set may occur when using Xypex Admix products. The amount of set delay will depend upon the concrete mix design, the particular Admix product used, dosage rate of the Admix, temperature of the concrete and climatic conditions. Concrete containing a Xypex Admix product may develop higher ultimate strengths than plain concrete. Conduct trial mixes under project conditions to determine setting time and strength of the concrete. Consult with manufacturer or manufacturer's representative regarding concrete mix design, project conditions and proper dosage rate.
- C. **Weather Conditions:** For mixing, transporting and placing concrete under conditions of high temperature or low temperature, follow concrete practices such as those referred to in ACI 305R (Hot Weather Concreting) and ACI 306R (Cold Weather Concreting) or other applicable standards.

3.03 Application

- A. **General:** Xypex Admix is added to the concrete at the time of batching. It is important to obtain a homogeneous mixture of Xypex Admix with the concrete. Do not add dry Admix powder directly to wet mixed concrete as this could cause clumping and thorough dispersion may not occur.
- B. **Concrete Batching & Mixing:** Procedures for addition of Xypex Admix will vary according to type of batch plant operation and equipment.
 1. Addition to Coarse Aggregate Belt: Add Xypex Admix powder directly to the coarse aggregate conveyor belt manually or through computer controlled mass batching system. Account for worker health and safety issues relating to moving belts and wind-blown dust.
 2. Addition to Ready Mixed Truck at Plant: Add Xypex Admix in bulk powder or soluble bag form to the drum of the ready-mix truck immediately prior to driving the truck under the batch plant. Then add the balance of the materials or the premixed concrete in accordance with standard concrete batching practices. Take measures to ensure that soluble bags are dispersed properly. Such measures can include: a) adding the bags as far forward in the drum as possible, b) adding a small amount of batch water along with the bags, and c) spinning the drum prior to adding remaining components. Avoid delays in adding

CRYSTALLINE WATERPROOFING ADDITIVE

other components and utilize high speed mixing to ensure homogeneity of mix. Where there may be insufficient water for thorough dispersion of the bulk powder, mix the Admix powder with water to form a slurry and add to the truck mixer drum prior to batching. Account for added water in the mix design and slump.

3. Addition to Central Mixer: Load the Xypex Admix in bulk powder form or in soluble bags along with the other components. Mix in accordance with standard batching practices to ensure thorough dispersion and a homogeneous mixture. Account for worker safety issues when accessing the equipment.
4. Precast Batch Plant - Pan Type Mixer: Add Xypex Admix to the rock and sand, then mix thoroughly for 2 - 3 minutes before adding the cement and water. The total concrete mass shall be blended using standard practices.

Note 1: Although addition on site in powder form is not normally recommended, it may be necessary. In such a case, add Xypex Admix to truck in slurry form (e.g. 3 parts powder to 2 parts water by volume). Mix concrete for a minimum of 5 minutes on high speed or until thoroughly dispersed. Account for added water in the mix design and slump.

Note 2: Consult with local Xypex Technical Services Representative concerning additional procedures for addition and mixing.

- C. **Construction and Cold Joints:** In addition to specified waterstops apply one coat of Xypex Concentrate slurry at a rate of 2 lb./sq.yd. (1 kg/m²) to joint surfaces between concrete pours. Moisten surfaces prior to slurry application. Apply slurry and keep moist for 12 hours then allow slurry to set or dry. Where joint surfaces are not accessible prior to pouring new concrete, contact Xypex Technical Services Representative for assistance.

Note: Inclusion, type and position of waterstops are at the discretion of the designer. Expanding waterstops may be placed on Xypex after it has dried or before Xypex slurry application. Xypex slurry may only be applied over waterstop if approved by waterstop manufacturer.

- D. **Sealing Strips:** Where hydrostatic conditions exist, sealing strips shall also be applied at construction joints by filling grooves that are created along the

joints. Dimensions of the grooves shall be 1 inch (25 mm) wide and 1.5 inches (37 mm) deep. If grooves are not been pre-formed then chip grooves to those dimensions. Fill the grooves as follows:

1. Apply slurry coat of Xypex Concentrate to slot in accordance with manufacturer's instructions or recommendations.
2. While slurry coat is still tacky, fill slot with Xypex Concentrate Dry-Pac.
3. Compact tightly using pneumatic packer or hammer and block.
4. Wet Dry-Pac surface lightly with water, then apply a slurry coat of Xypex Concentrate at a coverage rate of 1.5 - 2 lb./sq.yd. (0.8 - 1 kg/m²) over sealing strip and extending to 6" (150 mm) on either side.

Note: For further information, see Xypex Schematic Drawings for standard construction joint details.

- E. **Form Tie Holes:** Form tie holes shall be waterproofed in accordance with manufacturer's technical literature including relevant Method Statements (Section 1.3, p. 11-15). Procedures are generally as follows:

1. Prepare the tie hole to create a straight sided void with a profile of at least ICRI CSP-3. For through element ties holes such as those created by taper ties the prepared void is to be at least 5" (125 mm) deep. For cone ties the void is to be to the bottom of the cone.
2. Clean and profile the area to a 6 inch (150 mm) diameter around the tie hole to an ICRI CSP-3 profile.
3. For through-element tie holes create a solid plug of material at the bottom of the profiled hole using Xypex Patch'n Plug leaving at least 4" (100 mm) of empty tie hole from the top of the plug to the surface of the concrete element.
4. Apply a coat of Xypex Concentrate slurry at a rate of 1.5 lb./sq.yd. (0.8 kg/m²) to the inside of the tie hole and to a 12" (300 mm) diameter area around the hole.
5. Fill and compact the tie hole with Xypex Concentrate Dry-Pac.
6. Wet Dry-Pac surface lightly with water, then apply a slurry coat of Xypex Concentrate at a coverage rate of 1.5 - 2 lb. /sq.yd. (0.8 - 1 kg/m²) over the

CRYSTALLINE WATERPROOFING ADDITIVE

repaired area to a 12" (300 mm) diameter area around the filled void.

- F. **Repair of Defects:** Concrete defects shall be repaired in accordance with manufacturer's technical literature including relevant Method Statements (Section 1.3, p. 19-26). Procedures are generally as follows:

1. Cracks and Faulty Construction Joints:

a. Chip out cracks, faulty construction joints and other defects to a depth of 1.5 inches (37 mm) and a width of one inch (25 mm). A "V" shaped slot is not acceptable. The slot may be saw cut instead of chipped but ensure that the slot is dovetailed or otherwise shaped such that there will be mechanical interlock of materials placed into the slot at a later stage.

b. Clean slot of debris and dust. Soak area with water and remove excess surface water. Apply a slurry coat of Xypex Concentrate at the rate of 1.5 lb./sq.yd. (0.8 kg/m²) to the slot.

c. While slurry coat is still tacky, fill cavity with Dry-Pac. Compress tightly into cavity using pneumatic packer or block and hammer.

d. Wet Dry-Pac surface lightly with water, then apply a slurry coat of Xypex Concentrate at a coverage rate of 1.5 - 2 lb./sq.yd. (0.8 - 1 kg/m²) over the repaired area to 6" (150 mm) on either side of slot.

2. Rock Pockets, Honeycombing or other defective concrete: All areas of poor concrete consolidation (honeycomb or rock pockets) shall be repaired.

Note: Where there is active water-flow see Method Statements or contact a Xypex Technical Services Representative for assistance.

3.04 Placing

- A. **Concrete Placement:** Concrete placement shall be in accordance with "309R: Guide for Consolidation of Concrete" or other applicable standard. Special attention is to be given to consolidation at joints, penetrations and other potential leakage locations.

3.05 Curing

- A. **General:** Concrete containing Xypex Admix shall be moist cured in accordance with ACI 308, "Standard Practice for Curing Concrete" or other applicable standard.

- B. **Curing Compounds:** Curing compounds may be used in the event that project requirements or conditions prevent moist curing. Curing compounds shall comply with ASTM C-309 or other applicable standard.

3.06 Protection

- A. **Protection:** Protect installed product and finished surfaces from damage during construction.

3.07 Field Quality Control

- A. **Examination for Defects:** Do not conceal Xypex treated concrete before it has been observed by Architect/Engineer, waterproofing manufacturer's representative or other designated entities. Concrete shall be examined for structural defects such as honeycombing, rock pockets, tie holes, faulty construction joints, cold joints and cracks larger than 1/64" (0.4 mm). Such defects to be repaired in accordance with manufacturer's repair procedures as noted above.

B. **Testing for Tanks and Foundation Works**

1. Testing: Fill tanks or, for foundation works, shut off dewatering system as soon as practical so that the structure shall be exposed to its normal service conditions. Examine for leaks.

2. Monitoring:

a. Actively leaking cracks and joints shall be left to self-heal for as long as practical. Depending on job site and ambient conditions crack healing can be expected to take several days to weeks.

b. Any crack or joints that do not heal in the allowable time frame shall be repaired.

c. Moving cracks shall be repaired using polyurethane injection or other appropriate method.

3. Repair: Use Xypex repair procedures to seal any static crack or joint that does not self-heal. See Method Statements (Section 1.3, p. 19-24) or contact a Xypex Technical Services Representative for appropriate repair procedures.

Note: lower temperatures will extend the times for crystalline development.

3.08 Interaction with Other Materials

- A. **Backfilling:** Normal backfilling procedures may be used after concrete has been cured.

CRYSTALLINE WATERPROOFING ADDITIVE

- B. ***Grout, Cement Parge Coat, Plaster or Stucco:*** Xypex Admix treatment of concrete does not adversely affect the bond of subsequently applied materials. Follow surface preparation and other relevant directions of the coating or parge material manufacturer.
- C. ***Responsibility to Ensure Compatibility:*** Xypex Admix products are compatible with most admixtures used in the production of quality concrete. However, Xypex Chemical Corporation makes no representations or warranties regarding such compatibility of Xypex Admix products with other additives or admixtures. It shall be the responsibility of the concrete contractor to take whatever measures are necessary, including testing, to ensure compatibility of the Xypex Admix with other additives or admixtures being used in the concrete mix, and it shall be the responsibility of the installer of the surface-applied material that is to be applied over the Xypex treated concrete to take whatever measures are necessary, including testing, to ensure acceptance by or adhesion to the Xypex treated concrete.

END OF SECTION 033000

CRYSTALLINE WATERPROOFING DRY SHAKE

SECTION 033500

PART 1 – GENERAL

1.01 Summary

- A. **Section Includes:** Furnishing of all labor, materials, services and equipment necessary for the supply and installation of cementitious crystalline waterproofing (dry shake) to horizontal concrete surfaces as indicated on drawings and as specified herein.
- B. **Related Sections:**
1. Section 031000 - Concrete Forming
 2. Section 032000 - Concrete Reinforcement
 3. Section 033000 - Cast-In-Place Concrete
 4. Section 033600 - Concrete Finishing
 5. Section 079000 - Joint Protection
 6. Section 099000 - Paints and Coatings

1.02 References

- A. **Applicable Standards:** The following standards are referenced herein.
1. American Society for Testing and Materials (ASTM)
 2. Army Corps of Engineers (CRD)
 3. American National Standards Institute (ANSI)
 4. NSF International
 5. European Standards (EN)
 6. RILEM
 7. Drinking Water Inspectorate (DWI)

1.03 System Description

- A. **Cementitious Crystalline Waterproofing (Dry Shake):** Concrete waterproofing and protection system shall be of the crystalline type that is a blend of Portland cement, specially graded aggregate and active proprietary chemicals. When applied as a dry shake onto and floated into a fresh slab, the active chemicals diffuse into the concrete and cause a catalytic reaction which generates a non-soluble crystalline structure within the pores and capillary tracts of concrete. This crystalline system causes the concrete to become sealed against the penetration of liquids and protects the concrete from deterioration due to harsh environmental conditions. The system is used for above or below-grade slabs, including liquid retaining structures and where enhanced chemical resistance is required. For areas where increased abrasion resistance is required, utilize Xypex DS-2 which is formulated with a proprietary aggregate hardener.

1.04 System Performance Requirements

- A. **Testing Requirements:** Crystalline waterproofing system shall have been tested in accordance with the following standards and conditions, and the testing results shall meet or exceed the performance requirements as specified herein.
- B. **Independent Laboratory:** Testing shall have been performed by an accredited independent laboratory meeting the requirements of ASTM E 329 or other applicable international standard for certification of testing laboratories. Testing laboratory shall have obtained all control and treated concrete samples.
- C. **Crystalline Penetration:** Crystallizing capability of waterproofing material shall be evidenced by independent SEM (Scanning Electron Microscope) photographs. Crystal growth 12 inches (30 cm) from the surface of the coating shall be evident with 1000X magnification 1 year after application of the coating and exposure of the sample to normal weathering.
- D. **Permeability:** Independent testing shall be performed according to U.S. Army Corps of Engineers CRD C48 "Permeability of Concrete". Concrete samples shall have design strength of 2000 psi (14 MPa) and thickness of 2 inches (50 mm). Treated samples shall have two coats of crystalline waterproofing applied per manufacturer's directions. Samples to be pressure tested to 175 psi (405 foot head of water) or 1.2 MPa (123.4 m head of water). Control samples shall leak and treated samples, after crystalline growth has occurred, shall exhibit no measurable leakage.
- E. **Permeability - Negative Side Application:** Independent testing shall be performed according to EN 12390-8 or other recognized direct pressure test. Concrete samples shall have a design strength of 25 MPa (3600 psi). Treated samples shall be exposed to water pressure on the side opposite to the crystalline coating. Coated samples shall exhibit a greater than 90% reduction in depth of water penetration as compared to the control samples.
- F. **Chemical Resistance:** Independent testing shall be performed according to ASTM C 267 "Chemical Resistance of Mortars" and ASTM C 39 "Compressive Strength of Cylindrical Concrete Specimens". Concrete samples (treated and untreated) shall have design strength of 4000 psi (27.6 MPa). Treated samples shall have two coats of crystalline waterproofing

CRYSTALLINE WATERPROOFING DRY SHAKE

applied per manufacturer's directions. Untreated and treated specimens must be immersed for a minimum of 84 days in following chemical solutions: hydrochloric acid (3.5 pH), brake fluid, transformer oil, ethylene glycol, toluene, caustic soda. Treated specimens shall exhibit no detrimental effects after exposure, and shall have an average of 17% increase in compressive strength versus untreated control specimens.

- G. **Acid Resistance:** Independent testing shall be performed to determine "Sulfuric Acid Resistance of Concrete Specimens". Treated concrete samples shall be tested against untreated control samples. All samples shall be immersed in 5% sulfuric acid and weighed weekly for 10 weeks. Untreated samples shall exhibit at least 8 times more mass loss than treated samples.
- H. **Carbonation Resistance Testing:** Independent testing shall be performed according to RILEM CPC-18 or other recognized accelerated carbonation test. Concrete samples shall have a 0.5 w/cm ratio or be approximately 30 MPa (4500 psi) in strength. Coated samples shall have crystalline coating applied one day after casting and all samples to be cured for 7 days prior to carbonation. After 91 days exposure to CO₂ the coated samples shall show a 35% or greater reduction in carbonation depth as compared to the control samples.

1.05 Submittals

- A. **General:** Submit listed submittals in accordance with conditions of the Contract and with Division 1 Submittal Procedures Section.
- B. **Product Data:** Submit product data, including manufacturer's specifications, installation instructions, and general recommendations for waterproofing applications.
- C. **Test Reports:** Submit, for acceptance, complete test reports from approved independent testing laboratories certifying that waterproofing system conforms to performance characteristics and testing requirements specified herein.
- D. **Manufacturer's Certification:** Provide document signed by manufacturer or manufacturer's representative certifying that the materials to be installed comply with the requirements of this specification.

1.06 Quality Assurance

- A. **Manufacturer Qualifications:** Manufacturer shall be ISO 9001 registered, and shall have no less than 10 years experience in manufacturing the cementitious crystalline waterproofing materials for the required work. Manufacturer must be capable of providing field service representation during construction phase. Manufacturers who cannot provide ongoing field support or the performance test data specified herein will not be considered for the project.
- B. **Applicator:** Waterproofing applicator shall be experienced in the installation of dry shake cementitious materials as demonstrated by previous successful installations, and shall be approved by the manufacturer in writing.
- C. **Pre-Installation Conference:** Prior to installation of waterproofing, conduct meeting with waterproofing applicator, concrete placer, concrete finisher, Architect/Engineer, owner's representative, and waterproofing manufacturer's representative to verify and review the following:
 1. Project requirements for waterproofing as set out in Contract Document.
 2. Manufacturer's product data including application instructions.
- D. **Technical Consultation:** The waterproofing manufacturer's representative shall provide technical consultation on waterproofing application and provide on-site support as needed.

1.07 Delivery, Storage and Handling

- A. **Ordering:** Comply with manufacturer's ordering instructions and lead time requirements to avoid construction delays.
- B. **Delivery:** Deliver packaged waterproofing materials to project site in original undamaged containers, with manufacturer's labels and seals intact.
- C. **Storage:** Store waterproofing materials in dry, enclosed location, at a minimum temperature of 45°F (7°C).

1.08 Project Conditions

- A. **Compliance:** Comply with manufacturer's product data regarding condition of substrate to receive wa-

CRYSTALLINE WATERPROOFING DRY SHAKE

terproofing, weather conditions before and during installation, and protection of the installed waterproofing system.

1.08 Warranty

- A. **Project Warranty:** Refer to conditions of the Contract for project warranty provisions.
- B. **Manufacturer's Warranty:** Manufacturer shall provide standard product warranty executed by authorized company official.

PART 2 – PRODUCTS

2.01 Materials

- A. **Acceptable Manufacturer:**

Xypex Chemical Corporation
 13731 Mayfield Place
 Richmond, B.C., Canada V6V 2G9
 Tel: 800.961.4477 or 604.273.5265
 Fax: 604.270.0451 E-mail: info@xypex.com
 Website: www.xypex.com
- B. **Proprietary Products:** Xypex crystalline waterproofing materials as follows:
 1. Xypex Concentrate DS-1 (general applications)
 2. Xypex Concentrate DS-2 (where enhanced abrasion resistance is required)

Note: Supplemental specifications are available for Xypex Concentrate and Modified (coatings) and Xypex Admix C-series (additive) products.
- C. **Substitutions:** No substitutions permitted.
- D. **Source Quality:** Obtain proprietary crystalline waterproofing products from a single manufacturer.

2.02 Coverage

- A. **Dry Shake Materials:** Coverage rate for cementitious crystalline waterproofing shall be as follows:

Xypex Concentrate DS-1
 1.75 lb per sq.yd. (0.95 kg/m²)

Xypex Concentrate DS-2
 6.75 - 7.5 lb sq.yd. (3.6 - 4.0 kg/m²)

When using Xypex Concentrate DS-2 for enhanced impact and abrasion resistance, consult with manufacturer or its authorized representative to determine appropriate coverage rate.

PART 3 – EXECUTION

3.01 Manufacturer's Instructions

- A. **Compliance:** Comply with manufacturer's product data regarding installation, including technical bulletins, product catalogue, installation instructions and product packaging labels.

3.02 Project Conditions

- A. **Air Entrainment:** For best results, air content of the concrete should not exceed 3% (natural air only). If entrained air content is specified (e.g. for concrete that will be exposed to freeze-thaw cycle), consult with a manufacturer's technical representative for further application information.
- B. **Water Reducers and Supplementary Cementing Materials:** For certain concrete mix designs, we recommend a test panel be produced and evaluated for finishing. For example, higher performance concrete with a low water/ cement ratio, air entrainment, superplasticizers, fly ash or silica fume may reduce bleed water and make the concrete more difficult to finish. Consult with Xypex Technical Services for assistance.
- C. **Crack Control:** All reinforcement shall be in accordance with applicable standards. Concrete elements shall be designed and constructed to minimize and control cracking.
- D. **Joint Sealants:** Suitable flexible sealant or other flexible systems shall be used for expansion joints and chronic moving cracks.
- E. **Weather Conditions:** Environmental conditions (e.g. hot or cold temperatures) may affect the application and installation of the Dry Shake powder. In hot, dry or windy conditions where evaporation of bleed water is occurring, the DS powder should be applied immediately after Step 1 above (i.e. screeding). Keep top of slab from premature drying to ensure homogeneous mixture of DS powder into concrete paste. It is advisable to use an evaporation retardant on the fresh concrete.

CRYSTALLINE WATERPROOFING DRY SHAKE

3.03 Application

- A. **General:** Apply cementitious crystalline waterproofing (dry shake) after placement, consolidation and leveling of fresh concrete.
- B. **Concentrate DS-1:** Wait until concrete can be walked on leaving an indentation of 1/4 - 3/8 in. (6.5 - 9.5 mm). Concrete should be free of bleed water and be able to support the weight of a power trowel, then float open the surface. Immediately after floating open the surface, apply the dry shake material by hand or mechanical spreader. The dry shake material must be spread evenly. As soon as the dry shake material has absorbed moisture from the base slab, it must be floated into the surface. The DS-1 powder must be thoroughly worked into the cement paste using a float (not a trowel). Failure to utilize a float for this process could result in damage to the hardened surface (i.e. flaking, blistering or peeling). When concrete has hardened sufficiently, power trowel surface to the required finish.
- C. **Concentrate DS-2:** Wait until concrete can be walked on leaving an indentation of 1/4 - 3/8 in. (6.5 - 9.5 mm). Concrete should be free of bleed water and be able to support the weight of a power trowel, then float open the surface. Immediately after floating open the surface, apply one half of the dry shake material by hand or mechanical spreader. The dry shake material must be spread evenly. As soon as the dry shake material has absorbed moisture from the base slab, it must be floated into the surface. The DS-2 powder must be thoroughly worked into the cement paste using a float (not a trowel). Failure to utilize a float for this process could result in damage to the hardened surface (i.e. flaking, blistering or peeling). Immediately after power floating, apply remaining dry shake material at right angles to the first application. Allow remaining dry shake material to absorb moisture from the base slab and then power float the material into the surface. Again, it is essential that the DS-2 powder is thoroughly worked into the cement paste using a float (not a trowel). When concrete has hardened sufficiently, power trowel surface to the required finish.
- D. **Slab Edges:** Where edges of concrete slab set up earlier than main body of concrete, apply dry shake material to edges and finish with hand tools prior to proceeding with the dry shake application to the main body of concrete slab.

3.04 Curing

- A. **General:** Begin curing as soon as concrete has reached a final set but before the surface starts to dry. Conventional moist curing procedures such as water spray, wet burlap or plastic covers may be used in accordance with ACI Reference 308, "Standard Practice for Curing Concrete".
- B. **Curing Compounds:** Curing compounds may be used in the event that project requirements or conditions prevent moist curing. Curing compounds shall comply with ASTM C-309.

3.05 Protection

- A. **Protection:** Protect installed product and finished surfaces from damage during construction.

3.06 Interface With Other Materials

- A. **Paint, Epoxy or Similar Coatings:** Xypex DS-1 treatment of concrete does not adversely affect the bond of subsequently applied materials. After curing allow 21 days for chemical diffusion and then follow surface preparation and other relevant directions of the over coating material's manufacturer. For Xypex DS-2 contact Xypex Technical Services for assistance.
- B. **Responsibility to Ensure Compatibility:** Xypex Chemical Corporation makes no representations or warranties regarding compatibility of Xypex treatment with coatings, plasters, stuccos, tiles or other surface-applied materials. It shall be the responsibility of the installer of the surface-applied material that is to be applied over the Xypex waterproofing treatment, to take whatever measures are necessary, including testing, to ensure acceptance by or adhesion to the waterproofing treatment.

Note: Prior to the installation, it is recommended that a test section be completed under anticipated ambient and project conditions to demonstrate acceptable bond.

3.07 Field Quality Control

- A. **Examination for Defects:** Do not conceal Xypex treated concrete before it has been observed by Architect/Engineer, waterproofing manufacturer's representative or other designated entities. Concrete shall be examined for structural defects such as honeycombing, rock pockets, faulty construction joints, cold

CRYSTALLINE WATERPROOFING DRY SHAKE

joints and cracks larger than 1/64" (0.4 mm). Such defects to be repaired in accordance with manufacturer's Method Statements (Section 1.3, p. 19-26).

B. **Testing for Tanks and Foundation Works:**

1. Testing: Fill tanks or, for foundation works, shut off dewatering system as soon as practical so that the structure shall be exposed to its normal service conditions. Examine for leaks.
2. Monitoring:
 - a. Actively leaking cracks and joints shall be left to self-heal for as long as practical. Depending on job site and ambient conditions crack healing can be expected to take several days to weeks.
 - b. Any crack or joints that do not heal in the allowable time frame shall be repaired.
 - c. Moving cracks shall be repaired using polyurethane injection or other appropriate method.
3. Repair: Use Xypex repair procedures to seal any static crack or joint that does not self-heal. See Method Statements (Section 1.3, p. 19-24) or contact Xypex Technical Services Representative for appropriate repair procedures.

Note: Lower temperatures will extend the times for crystalline development.

3.08 Cleaning and Protection

- A. **Cleaning:** Clean spillage and soiling from adjacent surfaces using appropriate cleaning agents and procedures.
- B. **Protection:** Take measures to protect installed product and finished surfaces from damage after application.

END OF SECTION 033500

COATING SCHEMATIC DRAWINGS

Section	Page
Standard Construction Joint Details	
Traffic Bearing Slabs	1
Non-Traffic Bearing Slab & Walls	2
Wall onto Slab	3
Slab into Wall to Keep Water Out.....	4
Slab into Wall to Keep Water In.....	5
Standard Metal Pipe Detail	6
Concrete Wall & Slab	
Below Grade – Inside Application – Wall into Slab.....	7
Below Grade – Outside Application – Slab into Wall.....	8
Multi-level Concrete Wall & Slab	
Below Grade – Slab into Wall.....	9
Retaining Wall	10
Parking Deck	11
Roof / Plaza Deck.....	12
Hydraulic Elevator Pit.....	13
Elevator Pit / Sump Pit.....	14
Planter.....	15
Tunnel	16
Swimming Pool	17
Sewage Clarifier.....	18
Wall with Kicker.....	19
Reservoir / Wet Well.....	20
Underground Vault / Dry Well.....	21
Precast Concrete Manhole.....	22
CMU Block Wall	
Below Grade – Exterior Application.....	23
Below Grade – Interior Application.....	24
Above Grade – Exterior Application	25

STANDARD CONST. JOINT DETAILS – TRAFFIC BEARING SLABS

Not subject to hydrostatic pressure

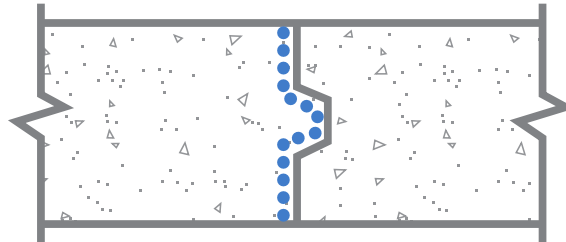

Subject to hydrostatic pressure

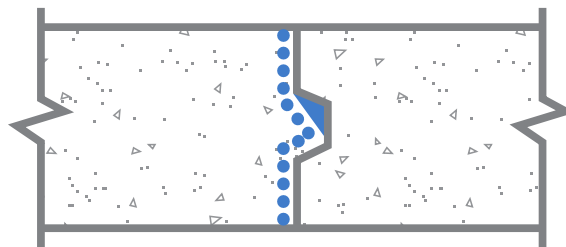

..... CONCENTRATE SLURRY COAT ■ CONCENTRATE DRY-PAC

STEP 1: Clean joint thoroughly.

STEP 2: Dampen keyway surface and apply in the corner of the keyway a fillet of Xypex Concentrate (dry-pac form to stiff mortar consistency). Add only enough water to allow the Xypex Concentrate Dry-Pac to be applied and consolidated.

STEP 3: Apply Xypex Concentrate slurry to joint surface, including over the sealing strip, at the rate of 2.0 lb./sq.yd. (1.0 kg/m²).

STEP 4: Pour concrete and cure in accordance with ACI, EN or other applicable international standard.

Note 1: Details are shown for joints that incorporate a keyway. Non-keyway joint assemblies are illustrated in the Admix Schematic Drawings.

Note 2: Schematic diagram shows Xypex application details only and does not depict standard requirements for waterstops or expansion joints. Inclusion, type and position of waterstops are at the discretion of the designer. Expanding waterstops may be placed on the slurry coat after it has dried or before application. Slurry coat may only be applied over waterstop if approved by waterstop manufacturer.

Note 3: Schematic drawing shows Xypex coating application. Specifier may consider the alternative use of Xypex dry shake (DS-Series) or Xypex additive (Admix C-Series). Refer to Xypex Standard Specifications for more information.

STANDARD CONST. JOINT DETAILS – NON-TRAFFIC BEARING SLAB & WALLS

Not subject to hydrostatic pressure

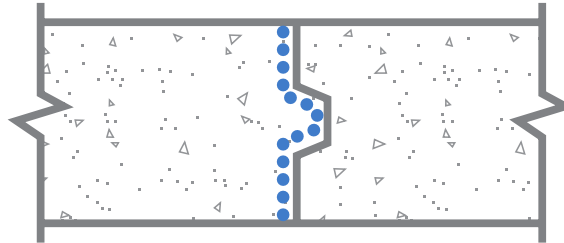

Subject to hydrostatic pressure

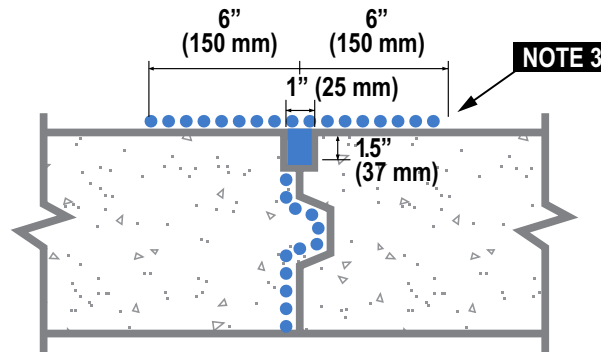

..... CONCENTRATE SLURRY COAT ■ CONCENTRATE DRY-PAC

STEP 1: Clean joint thoroughly. Apply Xypex Concentrate slurry to joint surface at the rate of 2.0 lb./sq.yd. (1.0 kg/m²).

STEP 2: Pour concrete and cure in accordance with ACI, EN or other applicable international standard.

STEP 3: Create a linear groove in the finished concrete surface. The linear groove is to be aligned with and included at all construction joints and to be 1" (25 mm) wide by 1½" (37 mm) deep. The linear groove may be offset to either side of the joint.

STEP 4: Clean linear groove thoroughly. Apply Xypex Concentrate slurry to linear groove at the rate of 1.5 lb./sq.yd. (0.8 kg/m²). Fill linear groove with Xypex Concentrate Dry-Pac and pack tightly to create the Xypex "sealing strip".

STEP 5: Apply Xypex Concentrate slurry at 1.5 lb./sq.yd. (0.8 kg/m²) over sealing strip and extending to 6" (150 mm) on either side. Cure for 48 - 72 hours in accordance with normal Xypex coatings curing procedures.

Note 1: Details are shown for joints that incorporate a keyway. Non-keyway joint assemblies are illustrated in the Admix Schematic Drawings.

Note 2: Schematic diagram shows Xypex application details only and does not depict standard requirements for waterstops or expansion joints. Inclusion, type and position of waterstops are at the discretion of the designer. Expanding waterstops may be placed on the slurry coat after it has dried or before application. Slurry coat may only be applied over waterstop if approved by waterstop manufacturer.

Note 3: The slurry coat over top of the sealing strip can be eliminated (Step 5) if Xypex coatings are to be applied over the area at a later stage in the project.

Note 4: Schematic drawing shows Xypex coating application. Specifier may consider the alternative use of Xypex dry shake (DS-Series) or Xypex additive (Admix C-Series). Refer to Xypex Standard Specifications for more information.

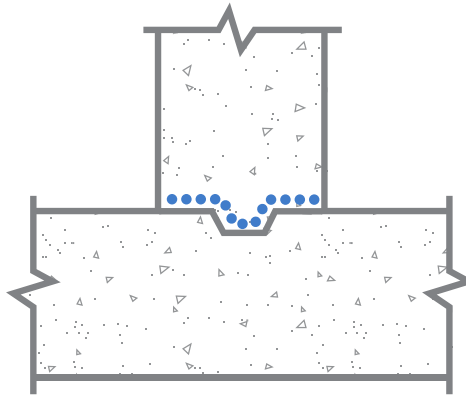
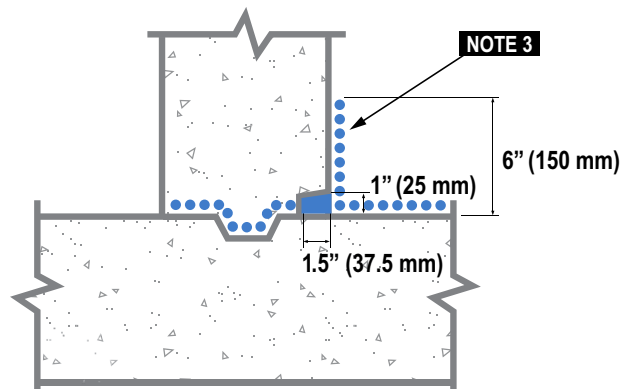
STANDARD CONST. JOINT DETAILS – WALL ONTO SLAB
Not subject to hydrostatic pressure

Subject to hydrostatic pressure

..... CONCENTRATE SLURRY COAT
 ■ CONCENTRATE DRY-PAC

STEP 1: Clean joint thoroughly. Apply Xypex Concentrate slurry to joint surface at the rate of 2.0 lb./sq.yd. (1.0 kg/m²).

STEP 2: On the side of the concrete element that will have direct water contact modify the formwork to create a linear groove in the finished concrete surface. The linear groove is to be aligned with the wall to slab joint and is to be 1" (25 mm) high by 1½" (37 mm) deep.

STEP 3: Pour concrete and cure in accordance with ACI, EN or other applicable international standard. Strip forms including formwork for linear groove.

STEP 4: Clean linear groove thoroughly. Apply Xypex Concentrate slurry to linear groove at the rate of 1.5 lb./sq.yd. (0.8 kg/m²). Fill linear groove with Xypex Concentrate Dry-Pac and pack tightly to create the Xypex "sealing strip".

STEP 5: Apply Xypex Concentrate slurry at 1.5 lb./sq.yd. (0.8 kg/m²) over sealing strip and extending to 6" (150 mm) on either side. Cure for 48 - 72 hours in accordance with normal Xypex coatings curing procedures.

Note 1: Details are shown for joints that incorporate a keyway. Non-keyway joint assemblies are illustrated in the Admix Schematic Drawings.

Note 2: Schematic diagram shows Xypex application details only and does not depict standard requirements for waterstops or expansion joints. Inclusion, type and position of waterstops are at the discretion of the designer. Expanding waterstops may be placed on the slurry coat after it has dried or before application. Slurry coat may only be applied over waterstop if approved by waterstop manufacturer.

Note 3: The slurry coat over top of the sealing strip shall be eliminated (Step 5) if Xypex coatings are to be applied over the area at a later stage in the project.

Note 4: Schematic drawing shows Xypex coating application. Specifier may consider the alternative use of Xypex dry shake (DS-Series) or Xypex additive (Admix C-Series). Refer to Xypex Standard Specifications for more information.

STANDARD CONST. JOINT DETAILS – SLAB INTO WALL TO KEEP WATER OUT

Not subject to hydrostatic pressure

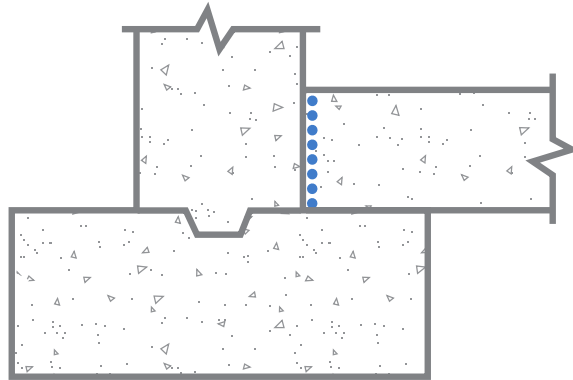

Subject to hydrostatic pressure

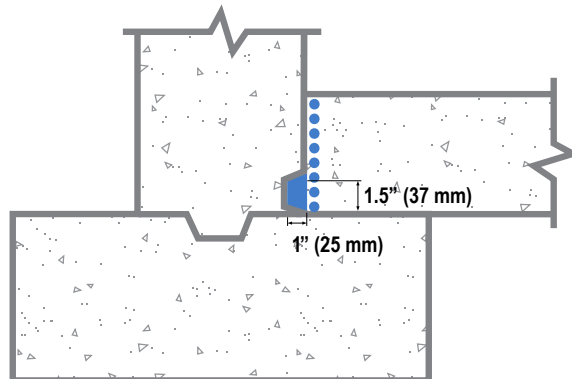

•••• CONCENTRATE SLURRY COAT ■ CONCENTRATE DRY-PAC

STEP 1: Where the slab will contact the wall modify the wall forms to create a linear groove in the finished concrete surface. The linear groove is to be aligned with the bottom of the slab and is to be 1½” (37 mm) deep.

STEP 2: Pour concrete and cure in accordance with ACI, EN or other applicable international standard. Strip forms including formwork for linear groove.

STEP 3: Clean joint including linear groove thoroughly. Apply Xypex Concentrate slurry to the linear groove at the rate of 1.5 lb./sq.yd. (0.8 kg/m²). Fill linear groove with Xypex Concentrate Dry-Pac and pack tightly to create the Xypex “sealing strip”.

STEP 4: Apply Xypex Concentrate slurry to joint surface, including over the sealing strip, at the rate of 2.0 lb./sq.yd. (1.0 kg/m²).

STEP 5: Pour slab as per Step 2.

Note 1: Details are shown for joints that incorporate a keyway. Non-keyway joint assemblies are illustrated in the Admix Schematic Drawings.

Note 2: Schematic diagram shows Xypex application details only and does not depict standard requirements for waterstops or expansion joints. Inclusion, type and position of waterstops are at the discretion of the designer. Expanding waterstops may be placed on the slurry coat after it has dried or before application. Slurry coat may only be applied over waterstop if approved by waterstop manufacturer.

Note 3: Schematic drawing shows Xypex coating application. Specifier may consider the alternative use of Xypex dry shake (DS-Series) or Xypex additive (Admix C-Series). Refer to Xypex Standard Specifications for more information.

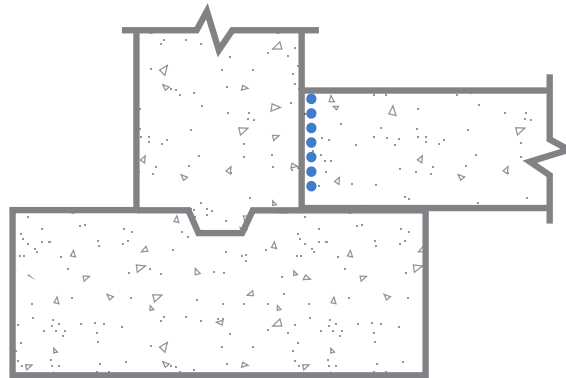
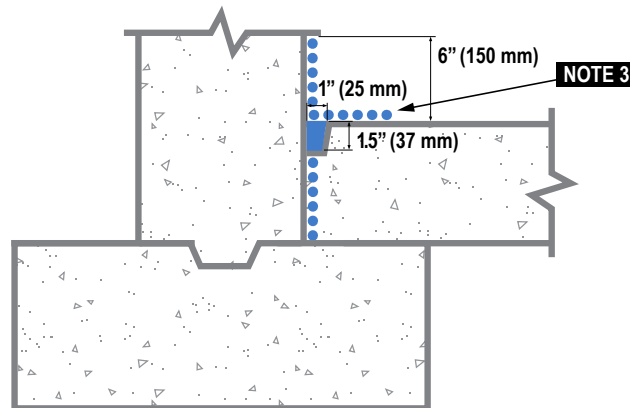
STANDARD CONST. JOINT DETAILS – SLAB INTO WALL TO KEEP WATER IN
Not subject to hydrostatic pressure

Subject to hydrostatic pressure

..... CONCENTRATE SLURRY COAT
 ■ CONCENTRATE DRY-PAC

STEP 1: Clean joint thoroughly. Apply Xypex Concentrate slurry to joint surface at the rate of 2.0 lb./sq.yd. (1.0 kg/m²).

STEP 2: Pour concrete and cure in accordance with ACI, EN or other applicable international standard. Strip forms including formwork for linear groove.

STEP 3: Where the slab will contact the wall, create a linear groove in the finished concrete surface of the slab. The linear groove is to be 1" (35 mm) wide by 1½" (37 mm) deep.

STEP 4: Clean linear groove thoroughly. Apply Xypex Concentrate slurry to the linear groove at the rate of 1.5 lb./sq.yd. (0.8 kg/m²). Fill linear groove with Xypex Concentrate Dry-Pac and pack tightly to create the Xypex "sealing strip".

STEP 5: Apply Xypex Concentrate slurry at 1.5 lb./sq.yd. (0.8 kg/m²) over sealing strip and extending to 6" (150 mm) on either side. Cure for 48 - 72 hours in accordance with normal Xypex coatings curing procedures.

Note 1: Details are shown for joints that incorporate a keyway. Non-keyway joint assemblies are illustrated in the Admix Schematic Drawings.

Note 2: Schematic diagram shows Xypex application details only and does not depict standard requirements for waterstops or expansion joints. Inclusion, type and position of waterstops are at the discretion of the designer. Expanding waterstops may be placed on the slurry coat after it has dried or before application. Slurry coat may only be applied over waterstop if approved by waterstop manufacturer.

Note 3: The slurry coat over top of the sealing strip shall be eliminated (Step 5) if Xypex coatings are to be applied over the area at a later stage in the project.

Note 4: Schematic drawing shows Xypex coating application. Specifier may consider the alternative use of Xypex dry shake (DS-Series) or Xypex additive (Admix C-Series). Refer to Xypex Standard Specifications for more information.

STANDARD METAL PIPE DETAIL

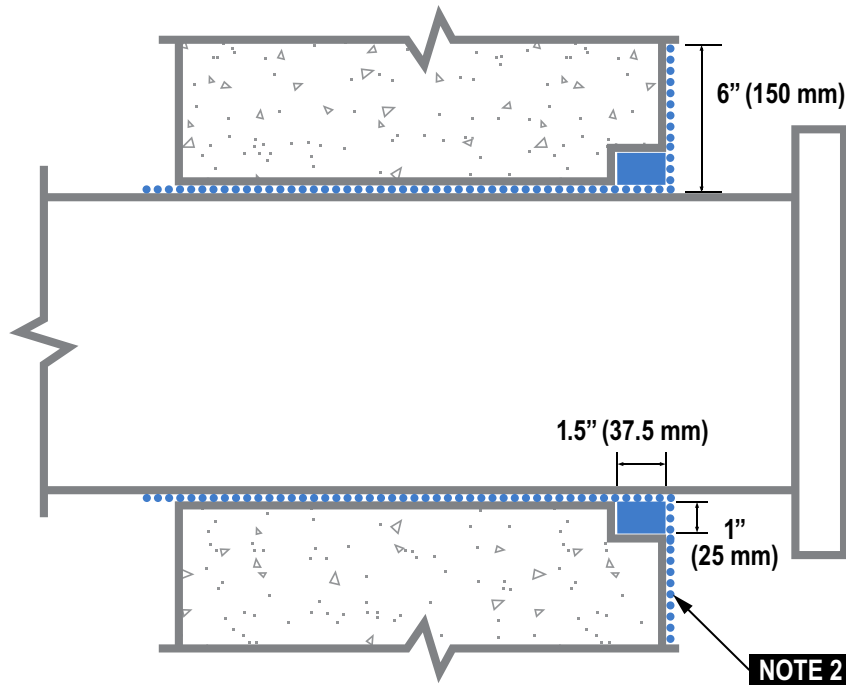

..... CONCENTRATE SLURRY COAT

■ CONCENTRATE DRY-PAC

STEP 1: Clean outside surface of pipe thoroughly and roughen with wire brush, sandpaper or other means. Apply Xypex Concentrate slurry coat to pipe surface at the rate of 2.0 lb./sq.yd. (1.0 kg/m²).

STEP 2: On water side modify the forms around the pipe to create a linear groove in the finished concrete surface. The linear groove is to be 1" (25 mm) high by 1½" (37 mm) deep and is to fully encircle the pipe.

STEP 3: Pour concrete and cure in accordance with ACI, EN or other applicable international standard. Strip forms including formwork for linear groove.

STEP 4: Clean linear groove thoroughly. Apply Xypex Concentrate slurry to the linear groove at the rate of 1.5 lb./sq.yd. (0.8 kg/m²). Fill linear groove with Xypex Concentrate Dry-Pac and pack tightly to create the Xypex "sealing strip".

STEP 5: Apply Xypex Concentrate slurry at 1.5 lb./sq.yd. (0.8 kg/m²) over sealing strip and extending to 6" (150 mm) from pipe. Cure for 48 - 72 hours in accordance with normal Xypex coatings curing procedures.

Note 1: Schematic diagram shows Xypex application details only and does not depict standard requirements for waterstops or expansion joints. Inclusion, type and position of waterstops are at the discretion of the designer. Expanding waterstops may be placed on the slurry coat after it has dried or before application. Slurry coat may only be applied over waterstop if approved by waterstop manufacturer.

Note 2: The slurry coat over top of the sealing strip shall be eliminated (Step 5) if Xypex coatings are to be applied over the area at a later stage in the project.

Note 3: Schematic drawing shows Xypex coating application. Specifier may consider the alternative use of Xypex dry shake (DS-Series) or Xypex additive (Admix C-Series). Refer to Xypex Standard Specifications for more information.

CONCRETE WALL & SLAB – INSIDE APPLICATION – WALL INTO SLAB

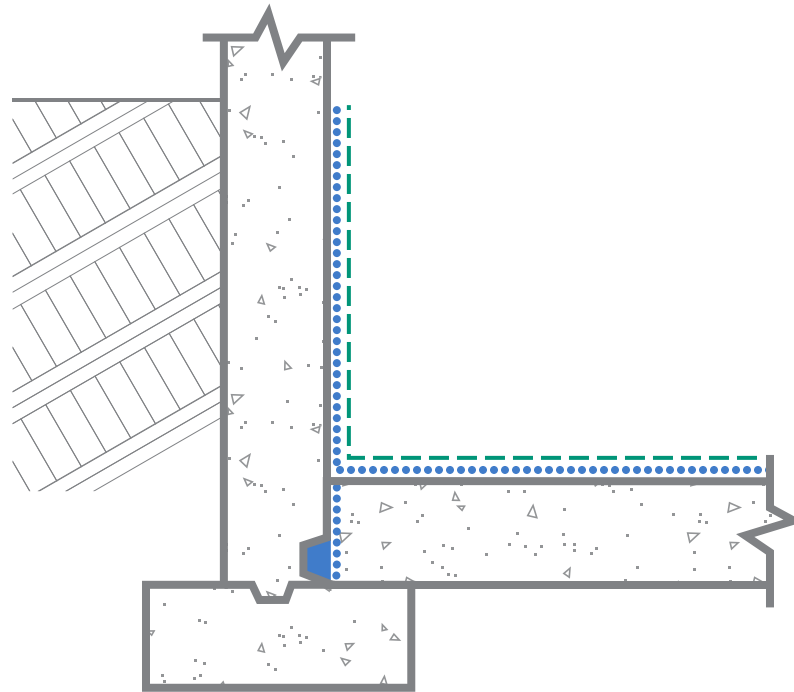

●●● CONCENTRATE SLURRY COAT
 ■ CONCENTRATE DRY-PAC
 - - - MODIFIED SLURRY COAT

STEP 1: Where the slab will contact the wall modify the wall forms to create a linear groove in the finished concrete surface. The linear groove is to be aligned with the bottom of the slab and is to be 1½" (37 mm) high by 1" (25 mm) deep.

STEP 2: Pour concrete and cure in accordance with ACI, EN or other applicable international standard. Strip forms including formwork for linear groove.

STEP 3: Clean joint including linear groove thoroughly. Apply Xypex Concentrate slurry to the linear groove at the rate of 1.5 lb./sq.yd. (0.8 kg/m²). Fill linear groove with Xypex Concentrate Dry-Pac and pack tightly to create the Xypex "sealing strip".

STEP 4: Apply Xypex Concentrate slurry at 2.0 lb./sq.yd. (1.0 kg/m²) over sealing strip and extending to the full area of contact with the slab.

STEP 5: Pour slab as per Step 2.

STEP 6: Thoroughly profile, clean and saturate the inside of walls and top of the slabs that will receive Xypex coatings. Surfaces shall have a "tooth and suction" ICRI CSP-3 profile and be fully saturated with no glistening water on the surface.

STEP 7: Apply one coat of Xypex Concentrate at the rate of 1.25 - 1.5 lb./sq.yd. (0.65 - 0.8 kg/m²). If a second coat is required after the Concentrate has set but while it is still

"green", apply either another coat of Xypex Concentrate or a coat of Xypex Modified at the rate of 1.25 - 1.5 lb./sq.yd. (0.65 - 0.8 kg/m²).

STEP 8: Cure by keeping coating moist by misting or fog spraying periodically with water for 2 - 3 days.

Note 1: A single heavy coat may be used in some situations. Contact Xypex Technical Services Representative for assistance.

Note 2: Details are shown for joints that incorporate a keyway. Non-keyway joint assemblies are illustrated in the Admix Schematic Drawings.

Note 3: Schematic diagram shows Xypex application details only and does not depict standard requirements for waterstops or expansion joints. Inclusion, type and position of waterstops are at the discretion of the designer. Expanding waterstops may be placed on the slurry coat after it has dried or before application. Slurry coat may only be applied over waterstop if approved by water-stop manufacturer.

Note 4: Schematic drawing shows Xypex coating application. Specifier may consider the alternative use of Xypex dry shake (DS-Series) or Xypex additive (Admix C-Series). Refer to Xypex Standard Specifications for more information.

CONCRETE WALL & SLAB – OUTSIDE APPLICATION – SLAB INTO WALL

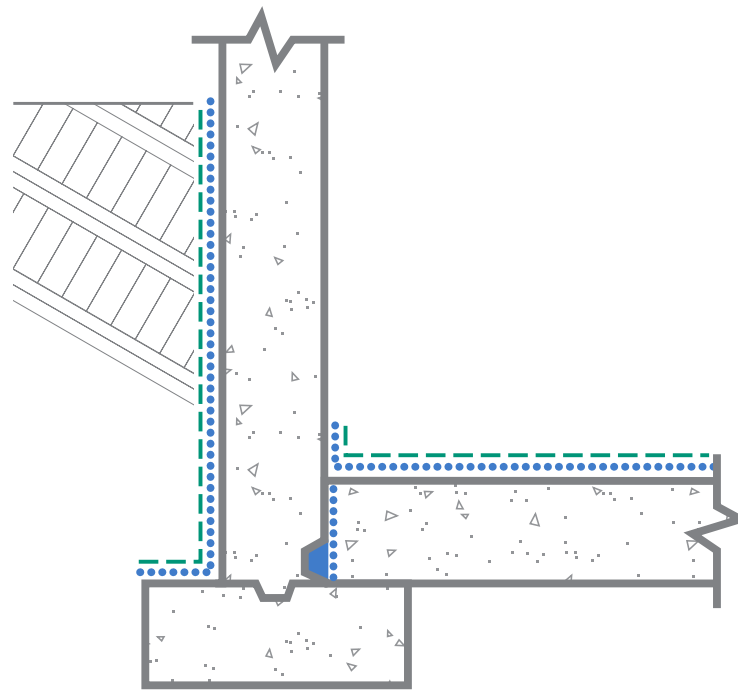

..... CONCENTRATE SLURRY COAT
 ■ CONCENTRATE DRY-PAC
 - - - MODIFIED SLURRY COAT

STEP 1: Where the slab will contact the wall modify the wall forms to create a linear groove in the finished concrete surface. The linear groove is to be aligned with the bottom of the slab and is to be 1½" (37 mm) high by 1" (25 mm) deep.

STEP 2: Pour concrete and cure in accordance with ACI, EN or other applicable international standard. Strip forms including formwork for linear groove.

STEP 3: Clean joint including linear groove thoroughly. Apply Xypex Concentrate slurry to the linear groove at the rate of 1.5 lb./sq.yd. (0.8 kg/m²). Fill linear groove with Xypex Concentrate Dry-Pac and pack tightly to create the Xypex "sealing strip".

STEP 4: Apply Xypex Concentrate slurry at 2.0 lb./sq.yd. (1.0 kg/m²) over sealing strip and extending to the full area of contact with the slab.

STEP 5: Pour slab as per Step 2.

STEP 6: Thoroughly profile, clean and saturate the outside surface of all walls and the top surface of slabs that will receive Xypex coatings. Surfaces shall have a "tooth and suction" ICRI CSP-3 profile and be fully saturated with no glistening water on the surface.

STEP 7: Apply one coat of Xypex Concentrate at the rate of 1.25 - 1.5 lb./sq.yd. (0.65 - 0.8 kg/m²). If a second coat is required after the Concentrate has set but while it is still

"green", apply either another coat of Xypex Concentrate or a coat of Xypex Modified at the rate of 1.25 - 1.5 lb./sq.yd. (0.65 - 0.8 kg/m²).

STEP 8: Cure by keeping coating moist by misting or fog spraying periodically with water for 2 - 3 days. Backfill and place into service as per Xypex coatings guidelines.

Note 1: A single heavy coat may be used in some situations. Contact Xypex Technical Services Representative for assistance.

Note 2: Details are shown for joints that incorporate a keyway. Non-keyway joint assemblies are illustrated in the Admix Schematic Drawings.

Note 3: Schematic diagram shows Xypex application details only and does not depict standard requirements for waterstops or expansion joints. Inclusion, type and position of waterstops are at the discretion of the designer. Expanding waterstops may be placed on the slurry coat after it has dried or before application. Slurry coat may only be applied over waterstop if approved by waterstop manufacturer.

Note 4: Schematic drawing shows Xypex coating application. Specifier may consider the alternative use of Xypex dry shake (DS-Series) or Xypex additive (Admix C-Series). Refer to Xypex Standard Specifications for more information.

MULTI-LEVEL CONCRETE WALL & SLAB – BELOW GRADE – SLAB INTO WALL

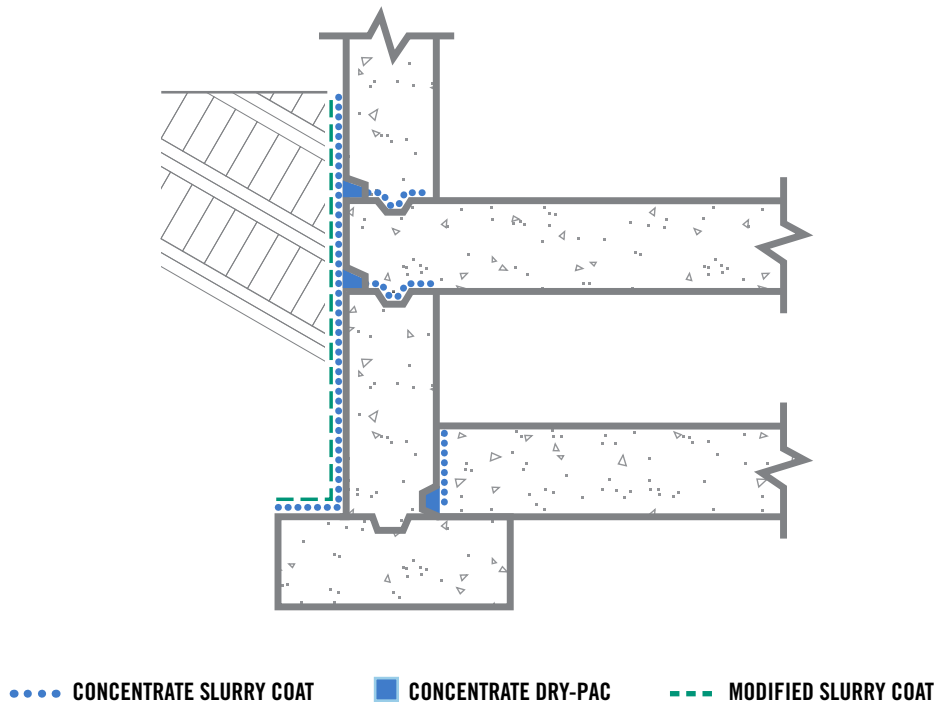

STEP 1: Where the bottom slab will contact the wall modify the wall forms to create a linear groove in the finished concrete surface. The linear groove is to be aligned with the bottom of the slab and is to be 1½" (37 mm) high by 1" (25 mm) deep.

STEP 2: Pour concrete and cure in accordance with ACI, EN or other applicable international standard. Strip forms including formwork for linear groove.

STEP 3: Clean joint including linear groove thoroughly. Apply Xypex Concentrate slurry to the linear groove at the rate of 1.5 lb./sq.yd. (0.8 kg/m²). Fill linear groove with Xypex Concentrate Dry-Pac and pack tightly to create the Xypex "sealing strip".

STEP 4: Apply Xypex Concentrate slurry at 2.0 lb./sq.yd. (1.0 kg/m²) over sealing strip and extending to the full area of contact with the slab.

STEP 5: Pour slab as per Step 2.

STEP 6: Clean wall joint thoroughly. Apply Xypex Concentrate slurry to joint surface at the rate of 2.0 lb./sq.yd. (1.0 kg/m²).

STEP 7: Modify the forms to create a linear groove in the exterior finished concrete surface at the suspended slab to wall joint. The linear groove is to be 1" (25 mm) high by 1½" (37 mm) deep.

STEP 8: Pour suspended slab as per Step 2 and strip forms including formwork for linear groove.

STEP 9: Clean joint including linear groove thoroughly. Apply Xypex Concentrate slurry to the linear groove at the rate of 1.5 lb./sq.yd. (0.8 kg/m²). Fill linear groove with Xypex Concentrate Dry-Pac and pack tightly to create the Xypex "sealing strip".

STEP 10: Thoroughly profile, clean and saturate the out- side surface of all walls and other concrete that will receive Xypex coatings. Surfaces to have a "tooth and suction" ICRI CSP-3 profile and be fully saturated with no glistening water on the surface.

STEP 11: Apply one coat of Xypex Concentrate at the rate of 1.25 - 1.5 lb./sq.yd. (0.65 - 0.8 kg/m²). If a second coat is required after the Concentrate has set but while it is still "green", apply either another coat of Xypex Concentrate or a coat of Xypex Modified at the rate of 1.25 - 1.5 lb./sq.yd. (0.65 - 0.8 kg/m²).

STEP 12: Cure by keeping coating moist by misting or fog spraying periodically with water for 2 - 3 days. Backfill and place into service per Xypex coatings guidelines.

Note 1: A single heavy coat may be used in some situations. Contact Xypex Technical Services Representative for assistance.

Note 2: Details are shown for joints that incorporate a keyway. Non-keyway joint assemblies are illustrated in the Admix Schematic Drawings.

Note 3: Schematic diagram shows Xypex application details only and does not depict standard requirements for waterstops or expansion joints. Inclusion, type and position of waterstops are at the discretion of the designer. Expanding waterstops may be placed on the slurry coat after it has dried or before application. Slurry coat may only be applied over waterstop if approved by water-stop manufacturer.

Note 4: Schematic drawing shows Xypex coating application. Specifier may consider the alternative use of Xypex dry shake (DS-Series) or Xypex additive (Admix C-Series). Refer to Xypex Standard Specifications for more information.

RETAINING WALL

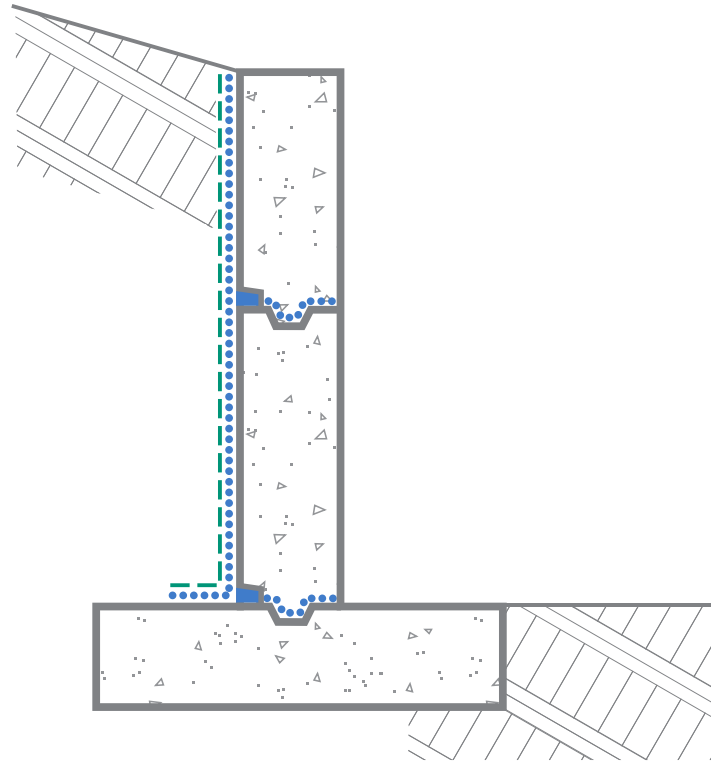

..... CONCENTRATE SLURRY COAT
 ■ CONCENTRATE DRY-PAC
 - - - MODIFIED SLURRY COAT

STEP 1: Clean joint thoroughly. Apply Xypex Concentrate slurry to joint surface at the rate of 2.0 lb./sq.yd. (1.0 kg/m²).

STEP 2: On the side of the concrete element that will have direct water contact, modify the forms to create a linear groove in the finished concrete surface. The linear groove is to be aligned with and included at all construction joints and to be 1" (25 mm) high by 1½" (37 mm) deep.

STEP 3: Pour concrete and cure in accordance with ACI, EN or other applicable international standard. Strip forms including formwork for linear groove.

STEP 4: Clean linear groove thoroughly. Apply Xypex Concentrate slurry to the linear groove at the rate of 1.5 lb./sq.yd. (0.8 kg/m²). Fill linear groove with Xypex Concentrate Dry-Pac and pack tightly to create the Xypex "sealing strip".

STEP 5: Thoroughly profile, clean and saturate the side of all walls that will have direct water contact and other concrete that will receive Xypex coatings. Surfaces to have a "tooth and suction" ICRI CSP-3 profile and be fully saturated with no glistening water on the surface.

STEP 6: Apply one coat of Xypex Concentrate at the rate of 1.25 - 1.5 lb./sq.yd. (0.65 - 0.8 kg/m²). If a second coat is required after the Concentrate has set but while it is still

"green", apply either another coat of Xypex Concentrate or a coat of Xypex Modified at the rate of 1.25 - 1.5 lb./sq.yd. (0.65 - 0.8 kg/m²).

STEP 7: Cure by keeping coating moist by misting or fog spraying periodically with water for 2 - 3 days. Backfill and place into service per Xypex coatings guidelines.

Note 1: A single heavy coat may be used in some situations. Contact Xypex Technical Services Representative for assistance.

Note 2: Details are shown for joints that incorporate a keyway. Non-keyway joint assemblies are illustrated in the Admix Schematic Drawings.

Note 3: Schematic diagram shows Xypex application details only and does not depict standard requirements for waterstops or expansion joints. Inclusion, type and position of waterstops are at the discretion of the designer. Expanding waterstops may be placed on the slurry coat after it has dried or before application. Slurry coat may only be applied over waterstop if approved by waterstop manufacturer.

Note 4: Schematic drawing shows Xypex coating application. Specifier may consider the alternative use of Xypex dry shake (DS-Series) or Xypex additive (Admix C-Series). Refer to Xypex Standard Specifications for more information.

PARKING DECK

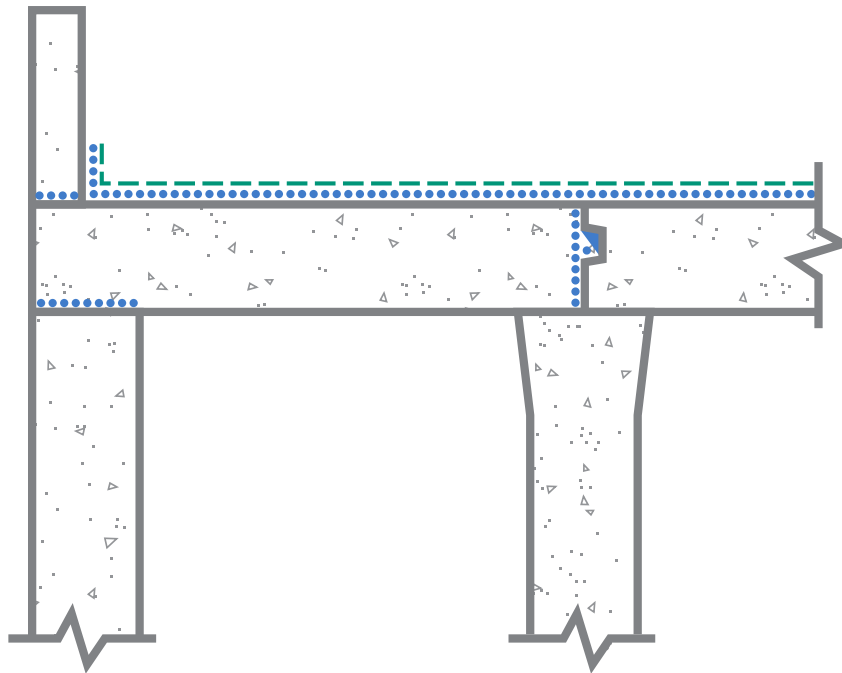

..... CONCENTRATE SLURRY COAT
 ■ CONCENTRATE DRY-PAC
 - - - MODIFIED SLURRY COAT

STEP 1: Clean joints, including keyway, thoroughly.

STEP 2: Dampen keyway surface and apply in the corner of the keyway a fillet of Xypex Concentrate (dry-pac to stiff mortar consistency). Add only enough water to allow the Xypex Concentrate Dry-Pac to be applied and consolidated.

STEP 3: Apply Xypex Concentrate slurry to joint surfaces, including over the sealing strip, at the rate of 2.0 lb./sq.yd. (1.0 kg/m²).

STEP 4: Pour concrete and cure in accordance with ACI, EN or other applicable international standard.

STEP 5: Thoroughly profile, clean and saturate the surface of the slab and other concrete that will receive Xypex coatings. Surfaces shall have a “tooth and suction” ICRI CSP-3 profile and be fully saturated with no glistening water on the surface.

STEP 6: Apply one coat of Xypex Concentrate at the rate of 1.25 - 1.5 lb./sq.yd. (0.65 - 0.8 kg/m²). If a second coat is required after the Concentrate has set but while it is still “green”, apply either another coat of Xypex Concentrate or a coat of Xypex Modified at the rate of 1.25 - 1.5 lb./sq.yd. (0.65 - 0.8 kg/m²).

STEP 7: Cure by keeping coating moist by misting or fog spraying periodically with water for 2 - 3 days. Care must be taken to avoid puddling of water during the curing pe-

riod. Damp burlap and specialty curing blankets may also be used. Contact Xypex regarding additional hardening of the coatings and opening to traffic.

Note 1: Parking decks are normally subject to variable live loads that may create movement in cracks beyond the ability of Xypex to heal. Consult Xypex Technical Services Representative for assistance.

Note 2: A single heavy coat may be used in some situations. Contact Xypex Technical Services Representative for assistance.

Note 3: Details are shown for joints that incorporate a keyway. Non-keyway joint assemblies are illustrated in the Admix Schematic Drawings.

Note 4: Schematic diagram shows Xypex application details only and does not depict standard requirements for waterstops or expansion joints. Inclusion, type and position of waterstops are at the discretion of the designer. Expanding waterstops may be placed on the slurry coat after it has dried or before application. Slurry coat may only be applied over waterstop if approved by waterstop manufacturer.

Note 5: Schematic drawing shows Xypex coating application. Specifier may consider the alternative use of Xypex dry shake (DS-Series) or Xypex additive (Admix C-Series). Refer to Xypex Standard Specifications for more information.

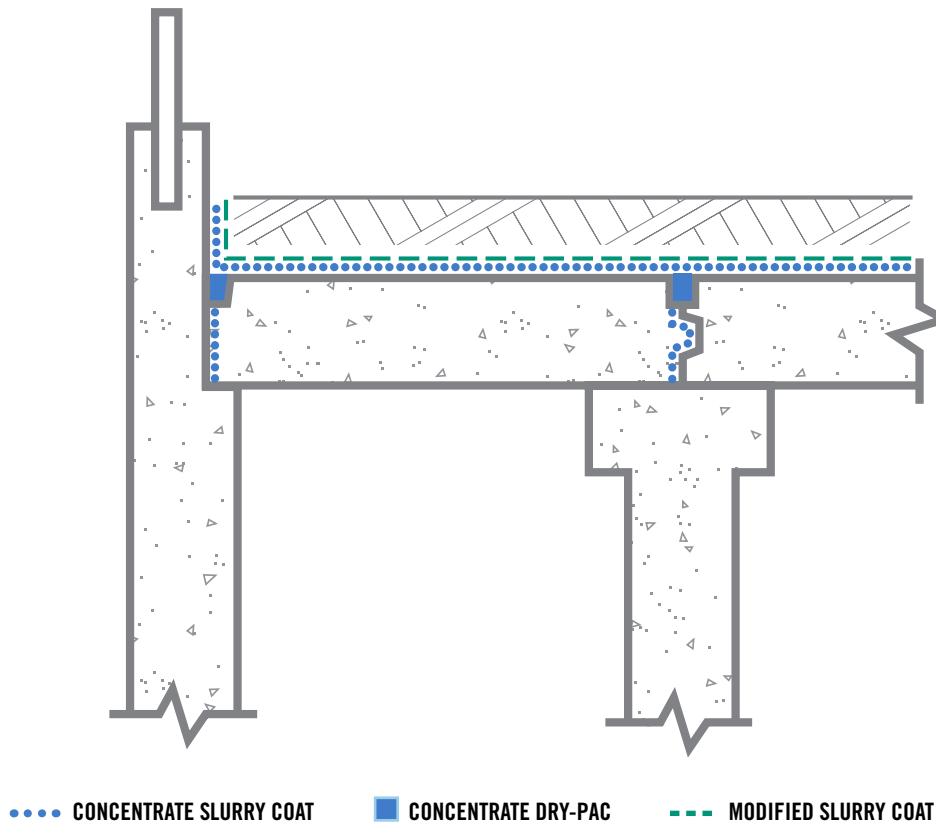
ROOF / PLAZA DECK

STEP 1: Clean joint thoroughly. Apply Xypex Concentrate slurry to joint surface at the rate of 2.0 lb./sq.yd. (1.0 kg/m²).

STEP 2: Pour concrete and cure in accordance with ACI, EN or other applicable international standard.

STEP 3: On top side of the concrete slab create a linear groove in the finished concrete surface. The linear groove is to be aligned with and included at all construction joints and to be 1" (25 mm) wide by 1½" (37 mm) deep. The linear groove may be offset to either side of the joint.

STEP 4: Clean linear groove thoroughly. Apply Xypex Concentrate slurry to the linear groove at the rate of 1.5 lb./sq.yd. (0.8 kg/m²). Fill linear groove with Xypex Concentrate Dry-Pac and pack tightly to create the Xypex "sealing strip".

STEP 5: Thoroughly profile, clean and saturate the concrete that will receive Xypex coatings. Surfaces to have a "tooth and suction" ICRI CSP-3 profile and be fully saturated with no glistening water on the surface.

STEP 6: Apply one coat of Xypex Concentrate at the rate of 1.25 - 1.5 lb./sq.yd. (0.65 - 0.8 kg/m²). If a second coat is required after the Concentrate has set but while it is still "green", apply either another coat of Xypex Concentrate or a coat of Xypex Modified at the rate of 1.25 - 1.5 lb./sq.yd. (0.65 - 0.8 kg/m²).

STEP 7: Cure by keeping coating moist by misting or fog spraying periodically with water for 2 - 3 days. Fill and place into service per Xypex coatings guidelines.

Note 1: Roof / plaza decks can be subject to variable live loads that may create movement in cracks beyond the ability of Xypex to heal. Contact Xypex Technical Services Representative for assistance.

Note 2: A single heavy coat may be used in some situations. Contact Xypex Technical Services Representative for assistance.

Note 3: Details are shown for joints that incorporate a keyway. Non-keyway joint assemblies are illustrated in the Admix Schematic Drawings.

Note 4: Schematic diagram shows Xypex application details only and does not depict standard requirements for waterstops or expansion joints. Inclusion, type and position of waterstops are at the discretion of the designer. Expanding waterstops may be placed on the slurry coat after it has dried or before application. Slurry coat may only be applied over waterstop if approved by waterstop manufacturer.

Note 5: Schematic drawing shows Xypex coating application. Specifier may consider the alternative use of Xypex dry shake (DS-Series) or Xypex additive (Admix C-Series). Refer to Xypex Standard Specifications for more information.

HYDRAULIC ELEVATOR PIT

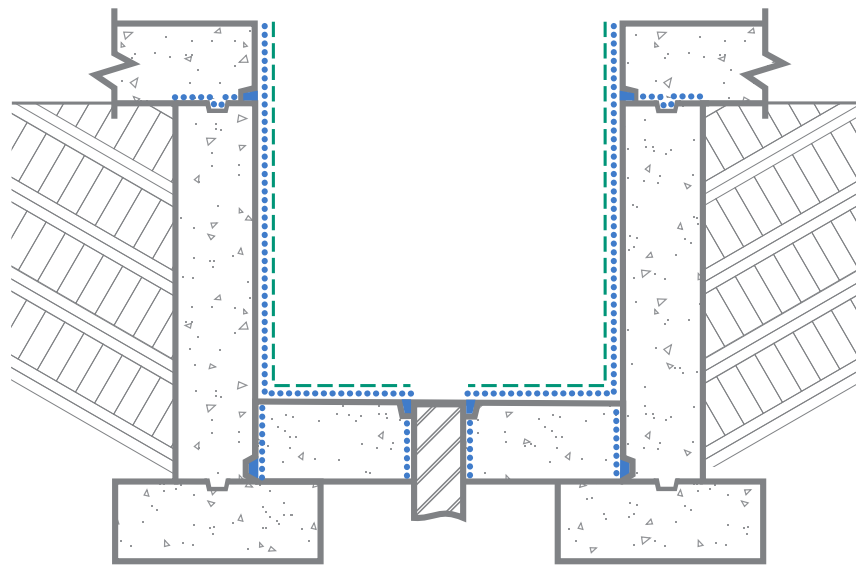

..... CONCENTRATE SLURRY COAT
 ■ CONCENTRATE DRY-PAC
 - - - MODIFIED SLURRY COAT

STEP 1: Where the slab will contact the wall modify the wall forms to create a linear groove in the finished concrete surface. The linear groove is to be aligned with the bottom of the slab and is to be 1½" (37 mm) high by 1" (25 mm) deep.

STEP 2: Pour concrete and cure in accordance with ACI, EN or other applicable international standard. Strip forms including formwork for linear groove.

STEP 3: Clean joint including linear groove thoroughly. Apply Xypex Concentrate slurry to the linear groove at the rate of 1.5 lb./sq.yd. (0.8 kg/m²). Fill linear groove with Xypex Concentrate Dry-Pac and pack tightly to create the Xypex "sealing strip".

STEP 4: Apply slurry of Xypex Concentrate at 2.0 lb./sq.yd. (1.0 kg/m²) over sealing strip and extending to the full area of contact with the slab.

STEP 5: Apply Xypex Concentrate slurry at a rate of 1.5 lb./sq.yd. (0.8 kg/m²) to the in ground cylinder casing where the concrete slab will interface with the steel cylinder.

STEP 6: Pour bottom slab as per Step 2. Tool around the in ground cylinder to form a 1" (25 mm) wide by 1½" (37 mm) deep linear groove around the cylinder casing. Clean linear groove thoroughly. Apply Xypex Concentrate slurry to the linear groove at the rate of 1.5 lb./sq.yd. (0.8 kg/m²). Fill linear groove with Xypex Concentrate Dry-Pac and pack tightly to create the Xypex "sealing strip".

STEP 7: Modify the forms to create a linear groove in the finished concrete surface at the upper slab to wall joint. The linear groove is to be 1" (25 mm) high by 1½" (37 mm) deep.

STEP 8: Clean joint thoroughly. Apply Xypex Concentrate slurry to joint surface at the rate of 2.0 lb./sq.yd. (1.0 kg/m²).

STEP 9: Pour concrete and strip forms. Clean linear groove thoroughly. Apply Xypex Concentrate slurry to the

linear groove at the rate of 1.5 lb./sq.yd. (0.8 kg/m²). Fill linear groove with Xypex Concentrate Dry-Pac and pack tightly to create the Xypex "sealing strip".

STEP 10: Thoroughly profile, clean and saturate the surface of all walls and other concrete that will receive Xypex coatings. Surfaces shall have a "tooth and suction" ICRI CSP-3 profile and be fully saturated with no glistening water on the surface

STEP 11: Apply one coat of Xypex Concentrate at the rate of 1.25 - 1.5 lb./sq.yd. (0.65 - 0.8 kg/m²). If a second coat is required after the Concentrate has set but while it is still "green", apply either another coat of Xypex Concentrate or a coat of Xypex Modified at the rate of 1.25 - 1.5 lb./sq.yd. (0.65 - 0.8 g/m²).

STEP 12: Cure by keeping coating moist by misting or fog spraying periodically with water for 2 - 3 days.

Note 1: A single heavy coat may be used in some situations. Contact Xypex Technical Services Representative for assistance.

Note 2: Details are shown for joints that incorporate a keyway. Non-keyway joint assemblies are illustrated in the Admix Schematic Drawings.

Note 3: Schematic diagram shows Xypex application details only and does not depict standard requirements for waterstops or expansion joints. Inclusion, type and position of waterstops are at the discretion of the designer. Expanding waterstops may be placed on the slurry coat after it has dried or before application. Slurry coat may only be applied over waterstop if approved by waterstop manufacturer.

Note 4: Schematic drawing shows Xypex coating application. Specifier may consider the alternative use of Xypex dry shake (DS-Series) or Xypex additive (Admix C-Series). Refer to Xypex Standard Specifications for more information.

ELEVATOR PIT / SUMP PIT

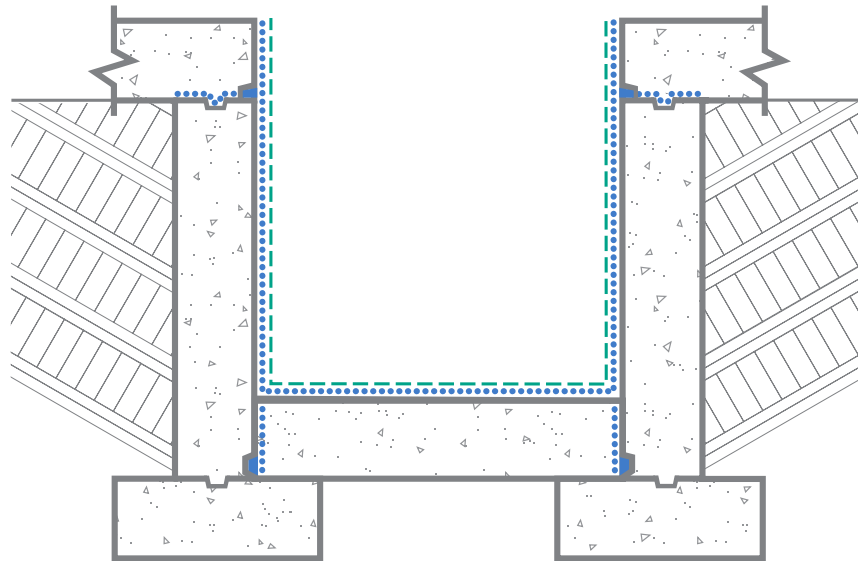

..... CONCENTRATE SLURRY COAT
 ■ CONCENTRATE DRY-PAC
 - - - - MODIFIED SLURRY COAT

STEP 1: Where the slab will contact the wall modify the wall forms to create a linear groove in the finished concrete surface. The linear groove is to be aligned with the bottom of the slab and is to be 1½" (37 mm) high by 1" (25 mm) deep.

STEP 2: Pour concrete and cure in accordance with ACI, EN or other applicable international standard. Strip forms including formwork for linear groove.

STEP 3: Clean joint including linear groove thoroughly. Apply Xypex Concentrate slurry to the linear groove at the rate of 1.5 lb./sq.yd. (0.8 kg/m²). Fill linear groove with Xypex Concentrate Dry-Pac and pack tightly to create the Xypex "sealing strip".

STEP 4: Apply Xypex Concentrate slurry at 2.0 lb./sq.yd. (1.0 kg/m²) over sealing strip and extending to the full area of contact with the slab.

STEP 5: Pour bottom slab as per Step 2.

STEP 6: Modify the forms to create a linear groove in the finished concrete surface at the upper slab to wall joint. The linear groove is to be 1" (25 mm) high by 1½" (37 mm) deep.

STEP 7: Clean joint thoroughly. Apply Xypex Concentrate slurry to joint surface at the rate of 2.0 lb./sq.yd. (1.0 kg/m²).

STEP 8: Pour concrete and strip forms. Clean linear groove thoroughly. Apply Xypex Concentrate slurry to the linear groove at the rate of 1.5 lb./sq.yd. (0.8 kg/m²). Fill linear groove with Xypex Concentrate Dry-Pac and pack tightly to create the Xypex "sealing strip".

STEP 9: Thoroughly profile, clean and saturate the surface of all walls, floor and other concrete that will receive

Xypex coatings. Surfaces shall have a "tooth and suction" ICRI CSP-3 profile and be fully saturated with no glistening water on the surface.

STEP 10: Apply one coat of Xypex Concentrate at the rate of 1.25 - 1.5 lb./sq.yd. (0.65 - 0.8 kg/m²). If a second coat is required after the Concentrate has set but while it is still "green", apply either another coat of Xypex Concentrate or a coat of Xypex Modified at the rate of 1.25 - 1.5 lb./sq.yd. (0.65 - 0.8 kg/m²).

STEP 11: Cure by keeping coating moist by misting or fog spraying periodically with water for 2 - 3 days.

Note 1: A single heavy coat may be used in some situations. Contact Xypex Technical Services Representative for assistance.

Note 2: Details are shown for joints that incorporate a keyway. Non-keyway joint assemblies are illustrated in the Admix Schematic Drawings.

Note 3: Schematic diagram shows Xypex application details only and does not depict standard requirements for waterstops or expansion joints. Inclusion, type and position of waterstops are at the discretion of the designer. Expanding waterstops may be placed on the slurry coat after it has dried or before application. Slurry coat may only be applied over waterstop if approved by water-stop manufacturer.

Note 4: Schematic drawing shows Xypex coating application. Specifier may consider the alternative use of Xypex dry shake (DS-Series) or Xypex additive (Admix C-Series). Refer to Xypex Standard Specifications for more information.

PLANTER

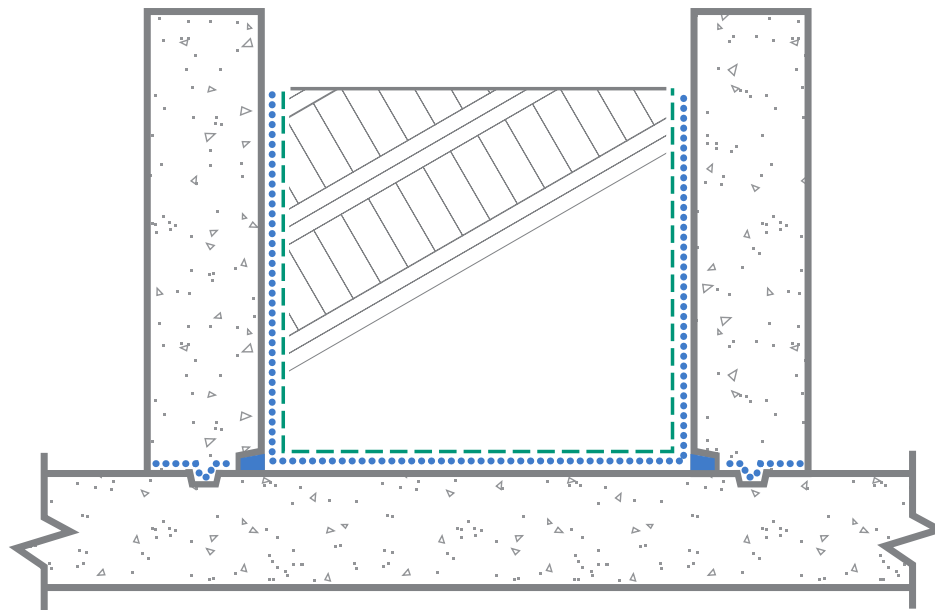

..... CONCENTRATE SLURRY COAT

■ CONCENTRATE DRY-PAC

- - - MODIFIED SLURRY COAT

STEP 1: Clean joint thoroughly. Apply Xypex Concentrate slurry to joint surface at the rate of 2.0 lb./sq.yd. (1.0 kg/m²).

STEP 2: On the inside of the planter, modify the forms to create a linear groove in the finished concrete surface. The linear groove is to be aligned with and included at all construction joints and to be 1" (25 mm) high by 1½" (37 mm) deep.

STEP 3: Pour concrete and cure in accordance with ACI, EN or other applicable international standard. Strip forms including formwork for linear groove.

STEP 4: Clean linear groove thoroughly. Apply Xypex Concentrate slurry to the linear groove at the rate of 1.5 lb./sq.yd. (0.8 kg/m²). Fill linear groove with Xypex Concentrate Dry-Pac and pack tightly to create the Xypex "sealing strip".

STEP 5: Thoroughly profile, clean and saturate the inside surface of all walls, floor and other concrete that will receive Xypex coatings. Surfaces to have a "tooth and suction" ICRI CSP-3 profile and be fully saturated with no glistening water on the surface.

STEP 6: Apply one coat of Xypex Concentrate at the rate of 1.25 - 1.5 lb./sq.yd. (0.65 - 0.8 kg/m²). If a second coat is required after the Concentrate has set but while it is still "green", apply either another coat of Xypex Concentrate

or a coat of Xypex Modified at the rate of 1.25 - 1.5 lb./sq.yd. (0.65 - 0.8 kg/m²).

STEP 7: Cure by keeping coating moist by misting or fog spraying periodically with water for 2 - 3 days. Fill and place into service per Xypex coatings guidelines.

Note 1: A single heavy coat may be used in some situations. Contact Xypex Technical Services Representative for assistance.

Note 2: Details are shown for joints that incorporate a keyway. Non-keyway joint assemblies are illustrated in the Admix Schematic Drawings.

Note 3: Schematic diagram shows Xypex application details only and does not depict standard requirements for waterstops or expansion joints. Inclusion, type and position of waterstops are at the discretion of the designer. Expanding waterstops may be placed on the slurry coat after it has dried or before application. Slurry coat may only be applied over waterstop if approved by waterstop manufacturer.

Note 4: Schematic drawing shows Xypex coating application. Specifier may consider the alternative use of Xypex dry shake (DS-Series) or Xypex additive (Admix C-Series). Refer to Xypex Standard Specifications for more information.

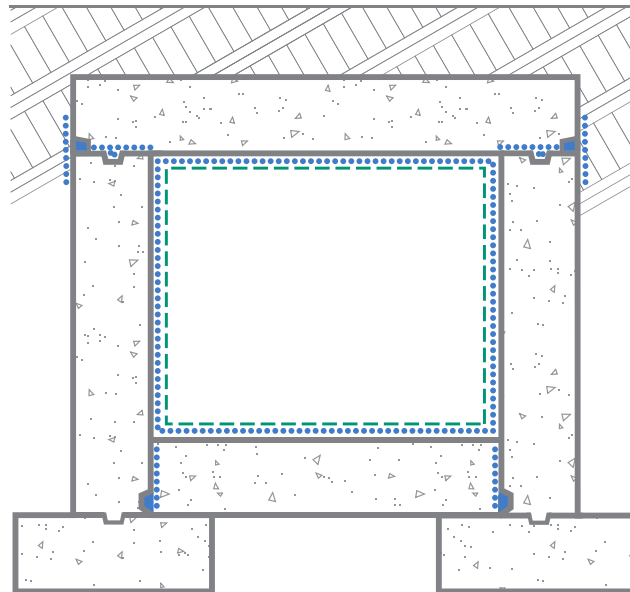
TUNNEL

..... CONCENTRATE SLURRY COAT
 ■ CONCENTRATE DRY-PAC
 - - - MODIFIED SLURRY COAT

STEP 1: Where the slab will contact the wall modify the wall forms to create a linear groove in the finished concrete surface. The linear groove is to be aligned with the bottom of the slab and is to be 1½" (37 mm) high by 1" (25 mm) deep.

STEP 2: Pour concrete and cure in accordance with ACI, EN or other applicable international standard. Strip forms including formwork for linear groove.

STEP 3: Clean joint including linear groove thoroughly. Apply Xypex Concentrate slurry to the linear groove at the rate of 1.5 lb./sq.yd. (0.8 kg/m²). Fill linear groove with Xypex Concentrate Dry-Pac and pack tightly to create the Xypex "sealing strip".

STEP 4: Apply slurry of Xypex Concentrate at 2.0 lb./sq.yd. (1.0 kg/m²) over sealing strip and extending to the full area of contact with the slab.

STEP 5: Pour slab as per Step 2.

STEP 6: At the bottom exterior surface of the upper slab to wall construction joint modify the forms to create a linear groove in the finished concrete surface. The linear groove is to be 1" (25 mm) high by 1½" (37 mm) deep.

STEP 7: Clean joint thoroughly. Apply Xypex Concentrate slurry to joint surface at the rate of 2.0 lb./sq.yd. (1.0 kg/m²).

STEP 8: Pour concrete and strip forms. Clean linear groove thoroughly. Apply Xypex Concentrate slurry to the linear groove at the rate of 1.5 lb./sq.yd. (0.8 kg/m²). Fill linear groove with Xypex Concentrate Dry-Pac and pack tightly to create the Xypex "sealing strip".

STEP 9: Apply Xypex Concentrate slurry at 1.5 lb./sq.yd. (0.8 kg/m²) over sealing strip and extending to 6" (150 mm) on either side. Cure for 48 - 72 hours in accordance with normal Xypex coatings curing procedures.

STEP 10: Thoroughly profile, clean and saturate the surface of all walls, floor, roof and other concrete that will

receive Xypex coatings. Surfaces shall have a "tooth and suction" ICRI CSP-3 profile and be fully saturated with no glistening water on the surface.

STEP 11: Apply one coat of Xypex Concentrate at the rate of 1.25 - 1.5 lb./sq.yd. (0.65 - 0.8 kg/m²). If a second coat is required after the Concentrate has set but while it is still "green", apply either another coat of Xypex Concentrate or a coat of Xypex Modified at the rate of 1.25 - 1.5 lb./sq.yd. (0.65 - 0.8 kg/m²).

STEP 12: Cure by keeping coating moist by misting or fog spraying periodically with water for 2 - 3 days. Backfill and place into service per Xypex coatings guidelines.

Note 1: Interior application of coatings is shown. Exterior application on walls and roof are also acceptable and preferred for new construction.

Note 2: A single heavy coat may be used in some situations. Contact Xypex Technical Services Representative for assistance.

Note 3: Details are shown for joints that incorporate a keyway. Non-keyway joint assemblies are illustrated in the Admix Schematic Drawings.

Note 4: Schematic diagram shows Xypex application details only and does not depict standard requirements for waterstops or expansion joints. Inclusion, type and position of waterstops are at the discretion of the designer. Expanding waterstops may be placed on the slurry coat after it has dried or before application. Slurry coat may only be applied over waterstop if approved by waterstop manufacturer.

Note 5: Schematic drawing shows Xypex coating application. Specifier may consider the alternative use of Xypex dry shake (DS-Series) or Xypex additive (Admix C-Series). Refer to Xypex Standard Specifications for more information.

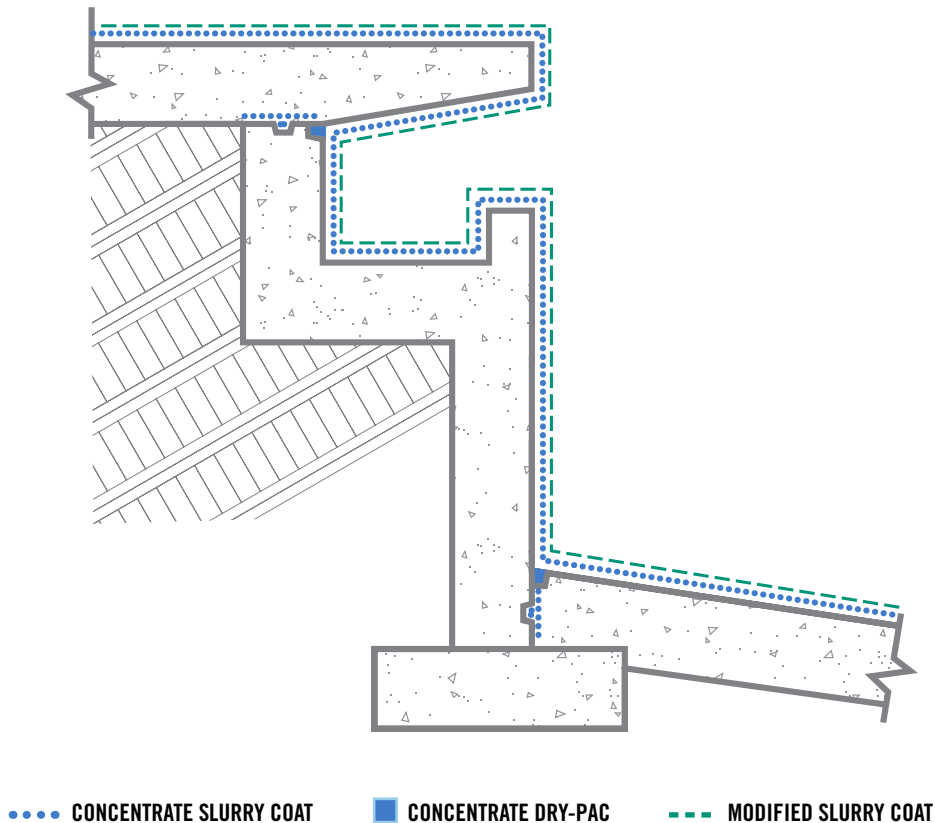
SWIMMING POOL

If tile, plaster or other finish will be applied, see Xypex Method Statement “Waterproofing of Dry-Mix Shotcrete Pools” (Section 1.3, p. 7-8) or contact Xypex Technical Services for more information.

STEP 1: Clean joint thoroughly. Apply Xypex Concentrate slurry to joint surface at the rate of 2.0 lb./sq.yd. (1.0 kg/m²).

STEP 2: On the inside of the pool, where the slab will contact the wall, create a linear groove in the finished concrete surface of the slab. The linear groove is to be aligned with and included at all slab to wall construction joints and to be 1” (35 mm) wide by 1½” (37 mm) deep.

STEP 3: Pour concrete and cure in accordance with ACI, EN or other applicable international standard. Strip forms including formwork for linear groove.

STEP 4: Clean linear groove thoroughly. Apply Xypex Concentrate slurry to the linear groove at the rate of 1.5 lb./sq.yd. (0.8 kg/m²). Fill linear groove with Xypex Concentrate Dry-Pac and pack tightly to create the Xypex “sealing strip”.

STEP 5: Thoroughly profile, clean and saturate the inside surface of all walls, floor and other concrete that will receive Xypex coatings. Surfaces shall have a “tooth and suction” ICRI CSP-3 profile and be fully saturated with no glistening water on the surface.

STEP 6: Apply one coat of Xypex Concentrate at the rate of 1.25 - 1.5 lb./sq.yd. (0.65 - 0.8 kg/m²). After the Concentrate has set but while it is still “green”, apply either a second coat of Xypex Concentrate or a coat of Xypex

Modified at the rate of 1.25 - 1.5 lb./sq.yd. (0.65 - 0.8 kg/m²). If tile, plaster or other finish will be applied, replace two coats with one heavy coat, 2.0 lb./sq.yd. (1.0 kg/m²) of Xypex Concentrate slurry. See Xypex Method Statement “Dry Mix Shotcrete Pools” or contact Xypex Technical Services for more information.

STEP 7: Cure by keeping coating moist by misting or fog spraying periodically with water for 2 - 3 days. Fill with water and place into service per Xypex coatings guidelines or in accordance with Xypex Method Statement.

Note 1: A single heavy coat may be used in some situations. Contact Xypex Technical Services Representative for assistance.

Note 2: Details are shown for joints that incorporate a keyway. Non-keyway joint assemblies are illustrated in the Admix Schematic Drawings.

Note 3: Schematic diagram shows Xypex application details only and does not depict standard requirements for waterstops or expansion joints. Inclusion, type and position of waterstops are at the discretion of the designer. Expanding waterstops may be placed on the slurry coat after it has dried or before application. Slurry coat may only be applied over waterstop if approved by waterstop manufacturer.

Note 4: Schematic drawing shows Xypex coating application. Specifier may consider the alternative use of Xypex dry shake (DS-Series) or Xypex additive (Admix C-Series). Refer to Xypex Standard Specifications for more information.

SEWAGE CLARIFIER

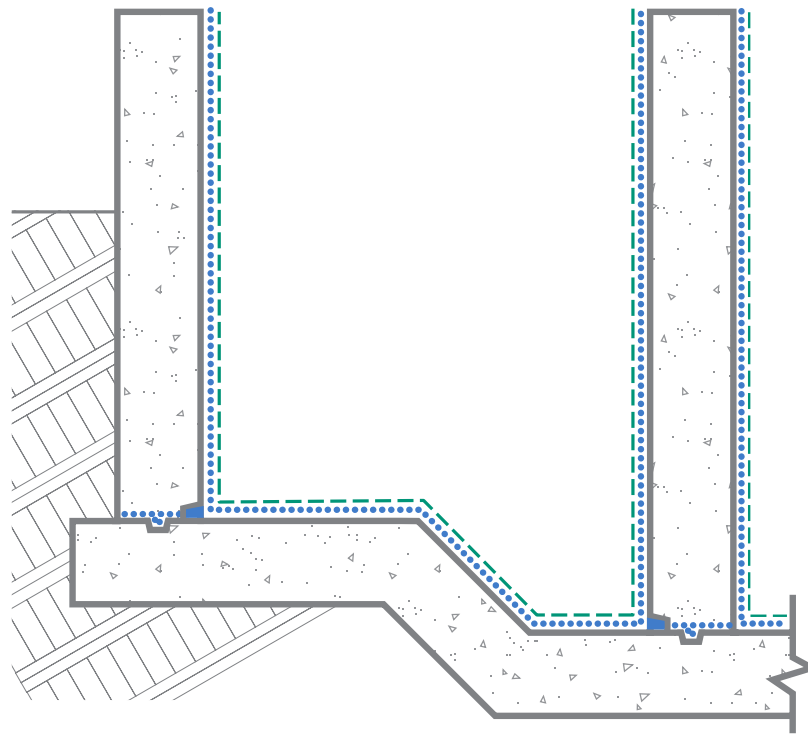

..... CONCENTRATE SLURRY COAT
 ■ CONCENTRATE DRY-PAC
 - - - MODIFIED SLURRY COAT

STEP 1: Clean joint thoroughly. Apply Xypex Concentrate slurry to joint surface at the rate of 2.0 lb./sq.yd. (1.0 kg/m²).

STEP 2: On the inside of the tank, modify the forms to create a linear groove in the finished concrete surface. The linear groove is to be aligned with and included at all construction joints and to be 1" (25 mm) high by 1½" (37 mm) deep.

STEP 3: Pour concrete and cure in accordance with ACI, EN or other applicable international standard. Strip forms including formwork for linear groove.

STEP 4: Clean linear groove thoroughly. Apply Xypex Concentrate slurry to the linear groove at the rate of 1.5 lb./sq.yd. (0.8 kg/m²). Fill linear groove with Xypex Concentrate Dry-Pac and pack tightly to create the Xypex "sealing strip".

STEP 5: Thoroughly profile, clean and saturate the inside surface of all walls, floor and other concrete that will receive Xypex coatings. Surfaces shall have a "tooth and suction" ICRI CSP-3 profile and be fully saturated with no glistening water on the surface.

STEP 6: Apply one coat of Xypex Concentrate at the rate of 1.25 - 1.5 lb./sq.yd. (0.65 - 0.8 kg/m²). After the Concentrate has set but while it is still "green", apply either a second coat of Xypex Concentrate or a coat of

Xypex Modified at the rate of 1.25 - 1.5 lb./sq.yd. (0.65 - 0.8 kg/m²).

STEP 7: Cure by keeping coating moist by misting or fog spraying periodically with water for 2 - 3 days. Fill with liquid and place into service per Xypex coatings guidelines.

Note 1: Details are shown for joints that incorporate a keyway. Non-keyway joint assemblies are illustrated in the Admix Schematic Drawings.

Note 2: A single heavy coat may be used in some situations. Contact Xypex Technical Services Representative for assistance.

Note 3: Schematic diagram shows Xypex application details only and does not depict standard requirements for waterstops or expansion joints. Inclusion, type and position of waterstops are at the discretion of the designer. Expanding waterstops may be placed on the slurry coat after it has dried or before application. Slurry coat may only be applied over waterstop if approved by waterstop manufacturer.

Note 4: Schematic drawing shows Xypex coating application. Specifier may consider the alternative use of Xypex dry shake (DS-Series) or Xypex additive (Admix C-Series). Refer to Xypex Standard Specifications for more information.

WALL WITH KICKER

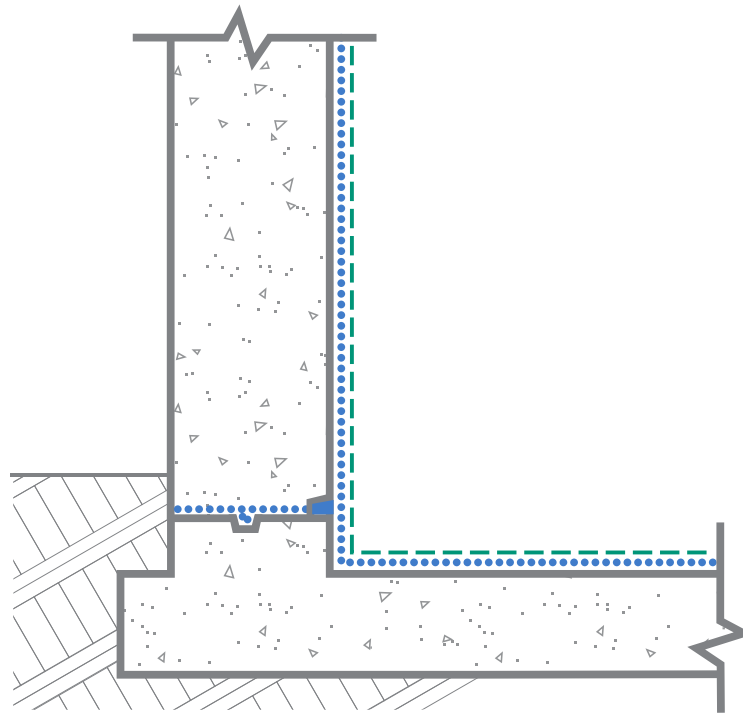

●●● CONCENTRATE SLURRY COAT
 ■ CONCENTRATE DRY-PAC
 - - - MODIFIED SLURRY COAT

STEP 1: Clean joint thoroughly. Apply Xypex Concentrate slurry to joint surface at the rate of 2.0 lb./sq.yd. (1.0 kg/m²).

STEP 2: On the inside of the tank, modify the forms to create a linear groove in the finished concrete surface. The linear groove is to be aligned with and included at all construction joints and to be 1" (25 mm) high by 1½" (37 mm) deep.

STEP 3: Pour concrete and cure in accordance with ACI, EN or other applicable international standard. Strip forms including formwork for linear groove.

STEP 4: Clean linear groove thoroughly. Apply Xypex Concentrate slurry to the linear groove at the rate of 1.5 lb./sq.yd. (0.8 kg/m²). Fill linear groove with Xypex Concentrate Dry-Pac and pack tightly to create the Xypex "sealing strip".

STEP 5: Thoroughly profile, clean and saturate the inside surface of all walls, floor and other concrete that will receive Xypex coatings. Surfaces shall have a "tooth and suction" ICR CSP-3 profile and be fully saturated with no glistening water on the surface.

STEP 6: Apply one coat of Xypex Concentrate at the rate of 1.25 - 1.5 lb./sq.yd. (0.65 - 0.8 kg/m²). After the Concentrate has set but while it is still "green", apply either a second coat of Xypex Concentrate or a coat of

Xypex Modified at the rate of 1.25 - 1.5 lb./sq.yd. (0.65 - 0.8 kg/m²).

STEP 7: Cure by keeping coating moist by misting or fog spraying periodically with water for 2 - 3 days. Place into service per Xypex coatings guidelines.

Note 1: A single heavy coat may be used in some situations. Contact Xypex Technical Services Representative for assistance.

Note 2: Details are shown for joints that incorporate a keyway. Non-keyway joint assemblies are illustrated in the Admix Schematic Drawings.

Note 3: Schematic diagram shows Xypex application details only and does not depict standard requirements for waterstops or expansion joints. Inclusion, type and position of waterstops are at the discretion of the designer. Expanding waterstops may be placed on the slurry coat after it has dried or before application. Slurry coat may only be applied over waterstop if approved by waterstop manufacturer.

Note 4: Schematic drawing shows Xypex coating application. Specifier may consider the alternative use of Xypex dry shake (DS-Series) or Xypex additive (Admix C-Series). Refer to Xypex Standard Specifications for more information.

RESERVOIR / WET WELL

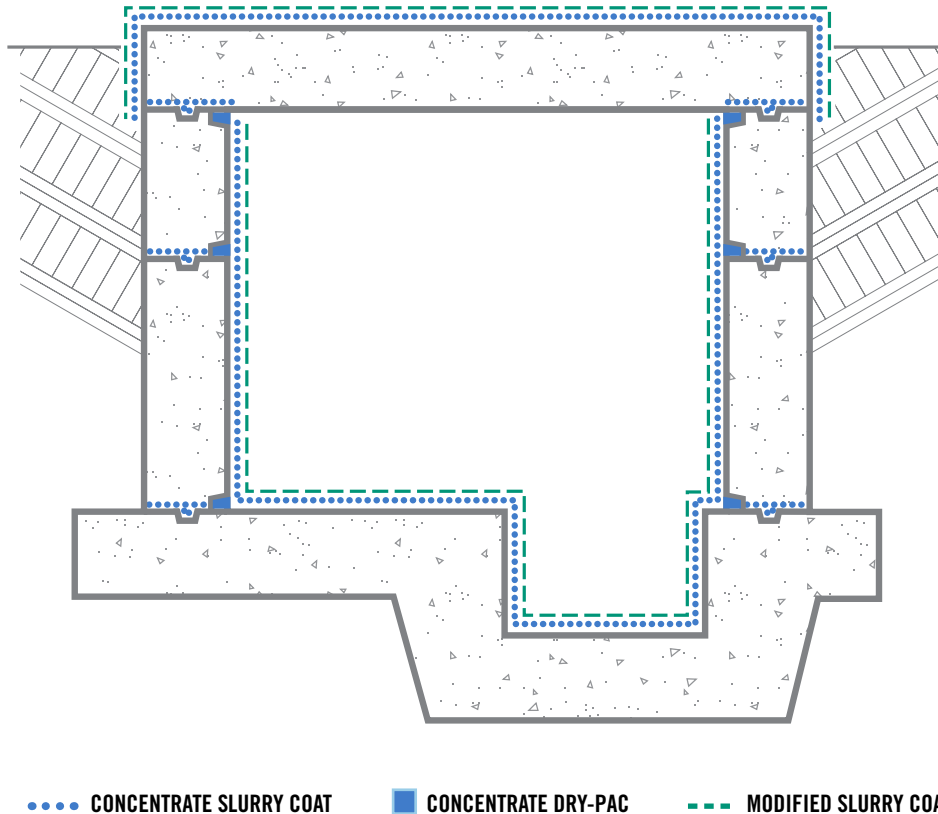

STEP 1: Clean joint thoroughly. Apply Xypex Concentrate slurry to joint surface at the rate of 2.0 lb./sq.yd. (1.0 kg/m²).

STEP 2: On the inside of the tank, modify the forms to create a linear groove in the finished concrete surface. The linear groove is to be aligned with and included at all construction joints and to be 1" (25 mm) high by 1½" (37 mm) deep.

STEP 3: Pour concrete and cure in accordance with ACI, EN or other applicable international standard. Strip forms including formwork for linear groove.

STEP 4: Clean linear groove thoroughly. Apply Xypex Concentrate slurry to the linear groove at the rate of 1.5 lb./sq.yd. (0.8 kg/m²). Fill linear groove with Xypex Concentrate Dry-Pac and pack tightly to create the Xypex "sealing strip".

STEP 5: Thoroughly profile, clean and saturate the inside surface of all walls, floor and the outside surface of the roof. Surfaces to have a "tooth and suction" ICRI CSP-3 profile and be fully saturated with no glistening water on the surface.

STEP 6: Apply one coat of Xypex Concentrate at the rate of 1.25 - 1.5 lb./sq.yd. (0.65 - 0.8 kg/m²). If a second coat is required after the Concentrate has set but while it is still "green", apply either another coat of Xypex Con-

centrate or a coat of Xypex Modified at the rate of 1.25 - 1.5 lb./sq.yd. (0.65 - 0.8 kg/m²).

STEP 7: Cure by keeping coating moist by misting or fog spraying periodically with water for 2 - 3 days. Fill with water and place into service per Xypex coatings guidelines.

Note 1: A single heavy coat may be used in some situations. Contact Xypex Technical Services Representative for assistance.

Note 2: Details are shown for joints that incorporate a keyway. Non-keyway joint assemblies are illustrated in the Admix Schematic Drawings.

Note 3: Schematic diagram shows Xypex application details only and does not depict standard requirements for waterstops or expansion joints. Inclusion, type and position of waterstops are at the discretion of the designer. Expanding waterstops may be placed on the slurry coat after it has dried or before application. Slurry coat may only be applied over waterstop if approved by waterstop manufacturer.

Note 4: Schematic drawing shows Xypex coating application. Specifier may consider the alternative use of Xypex dry shake (DS-Series) or Xypex additive (Admix C-Series). Refer to Xypex Standard Specifications for more information.

UNDERGROUND VAULT / DRY WELL

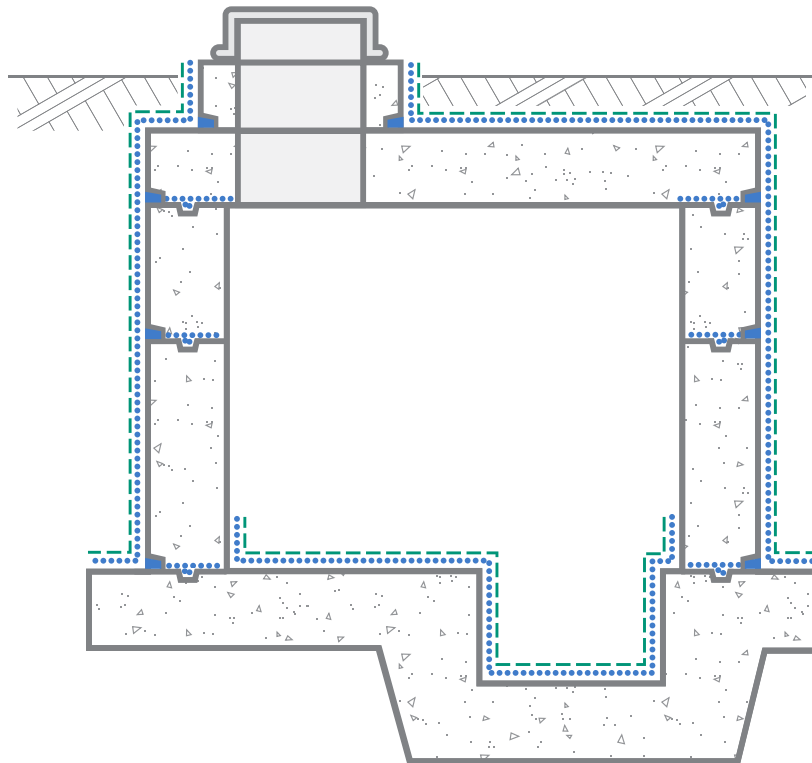

..... CONCENTRATE SLURRY COAT
 ■ CONCENTRATE DRY-PAC
 - - - MODIFIED SLURRY COAT

STEP 1: Clean joint thoroughly. Apply Xypex Concentrate slurry to joint surface at the rate of 2.0 lb./sq.yd. (1.0 kg/m²).

STEP 2: On the outside of vault/dry well, modify the forms to create a linear groove in the finished concrete surface. The linear groove is to be aligned with and included at all construction joints and to be 1" (25 mm) high by 1½" (37 mm) deep.

STEP 3: Pour concrete and cure in accordance with ACI, EN or other applicable international standard. Strip forms including formwork for linear groove.

STEP 4: Clean linear groove thoroughly. Apply Xypex Concentrate slurry to the linear groove at the rate of 1.5 lb./sq.yd. (0.8 kg/m²). Fill linear groove with Xypex Concentrate Dry-Pac and pack tightly to create the Xypex "sealing strip".

STEP 5: Thoroughly profile, clean and saturate the surface of the floor and the outside surface of the walls, roof, accessway and other concrete that will receive Xypex coatings. Surfaces to have a "tooth and suction" ICRI CSP-3 profile and be fully saturated with no glistening water on the surface.

STEP 6: Apply one coat of Xypex Concentrate at the rate of 1.25 - 1.5 lb./sq.yd. (0.65 - 0.8 kg/m²). If a second coat is required after the Concentrate has set but while it is still "green", apply either another coat of Xypex Con-

centrate or a coat of Xypex Modified at the rate of 1.25 - 1.5 lb./sq.yd. (0.65 - 0.8 kg/m²).

STEP 7: Cure by keeping coating moist by misting or fog spraying periodically with water for 2 - 3 days. Backfill and place into service per Xypex coatings guidelines.

Note 1: A single heavy coat may be used in some situations. Contact Xypex Technical Services Representative for assistance.

Note 2: Details are shown for joints that incorporate a keyway. Non-keyway joint assemblies are illustrated in the Admix Schematic Drawings.

Note 3: Schematic diagram shows Xypex application details only and does not depict standard requirements for waterstops or expansion joints. Inclusion, type and position of waterstops are at the discretion of the designer. Expanding waterstops may be placed on the slurry coat after it has dried or before application. Slurry coat may only be applied over waterstop if approved by waterstop manufacturer.

Note 4: Schematic drawing shows Xypex coating application. Specifier may consider the alternative use of Xypex dry shake (DS-Series) or Xypex additive (Admix C-Series). Refer to Xypex Standard Specifications for more information.

PRECAST CONCRETE MANHOLE

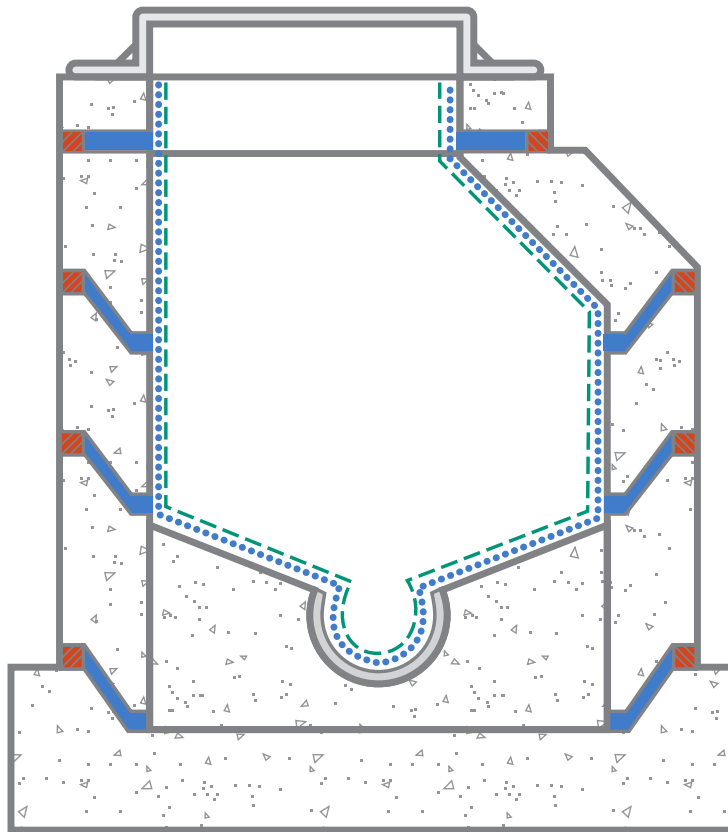

..... CONCENTRATE SLURRY COAT
 ■ CONCENTRATE DRY-PAC
 - - - MODIFIED SLURRY COAT
 ▨ PATCH'N PLUG

Steps 1 and 2 are used when waterproof gasketting or other assemblies are not included.

STEP 1: Place blocks in joints to allow 0.5" - 0.75" (13 - 19 mm) gap between precast sections. Fill exterior gap with Xypex Patch'n Plug or Xypex Megamix II to a depth of 2" - 3" (50 - 75 mm).

STEP 2: In the interior of the manhole, apply slurry of Xypex Concentrate to the interior gap at the rate of 1.5 lb./sq.yd. (0.8 kg/m²) then fill gap to the surface with Xypex Concentrate in Dry-Pac.

STEP 3: Thoroughly profile, clean and saturate the inside surface of all walls, floor, invert and other concrete that will receive Xypex coatings. Surfaces to have a "tooth and suction" ICRI CSP-3 profile and be fully saturated with no glistening water on the surface.

STEP 4: Apply one coat of Xypex Concentrate at the rate of 1.25 - 1.5 lb./sq.yd. (0.65 - 0.8 kg/m²). If a second coat is required after the Concentrate has set but while it is still "green", apply either another coat of Xypex Concentrate or a coat of Xypex Modified at the rate of 1.25 - 1.5 lb./sq.yd. (0.65 - 0.8 kg/m²).

STEP 5: Cure by keeping coating moist by misting or fog spraying periodically with water for 2 - 3 days. Backfill and place into service per Xypex coatings guidelines.

Note 1: A single heavy coat may be used in some situations. Contact Xypex Technical Services Representative for assistance.

Note 2: Schematic drawing shows Xypex coating application. Specifier may consider the alternative use of Xypex dry shake (DS-Series) or Xypex additive (Admix C-Series). Refer to Xypex Standard Specifications for more information.

CMU BLOCK WALL – BELOW GRADE – EXTERIOR APPLICATION

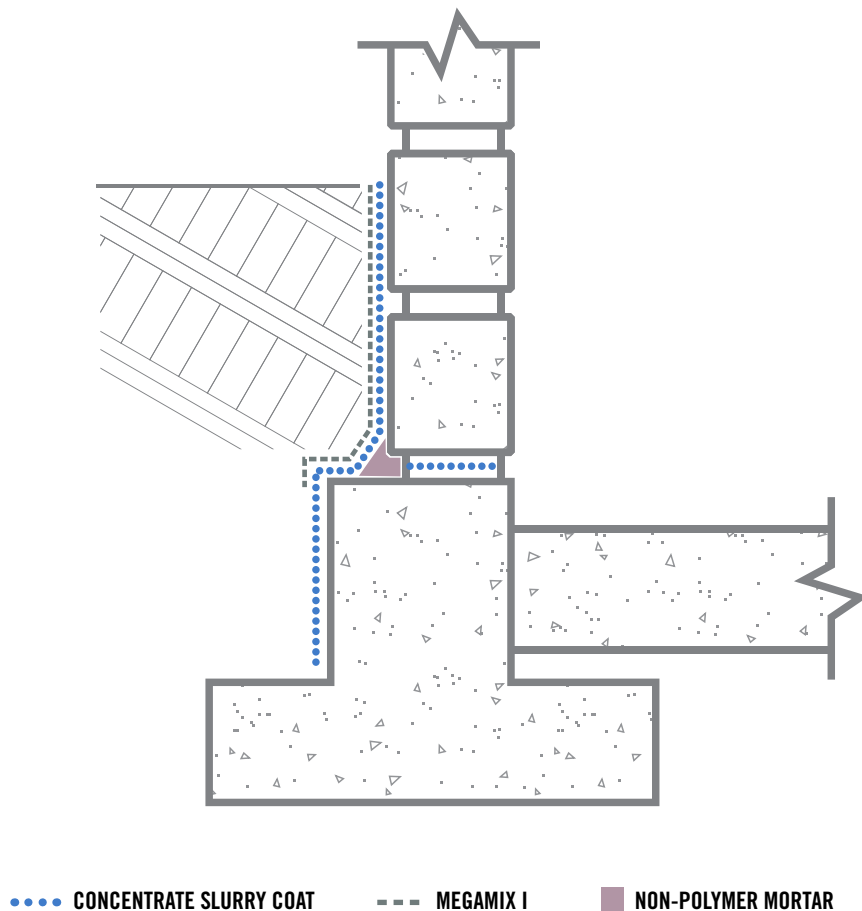

STEP 1: Clean joint thoroughly. Apply Xypex Concentrate slurry to joint surface at the rate of 2.0 lb./sq.yd. (1.0 kg/m²).

STEP 2: At the base of the wall on the exterior install a triangulare cove of good quality, non-polymer modified mortar.

STEP 3: Thoroughly profile, clean and saturate the outside surface of all CMU block walls as well as any concrete surfaces that will receive Xypex coatings. Surfaces to have a “tooth and suction” ICRI CSP-3 profile and be fully saturated with no glistening water on the surface.

STEP 4: As shown, install a fillet of good quality non-polymer modified mortar at CMU to concrete interface.

STEP 5: Apply one coat of Xypex Concentrate at the rate of 2.0 lb./sq.yd. (1.0 kg/m²) to all CMU block and concrete. Allow Xypex Concentrate coating to set and harden for between 12 hours and 24 hours (no more than 48 hours). During this time, moist cure coating per Xypex product data sheet.

STEP 6: Apply one coat of Megamix I over top of Xypex Concentrate coated CMU only. Apply Megamix I at a thickness of 1/8” (3 mm) or 11.25 lb./sq.yd. (5.6 kg/m²). Thickness of top coating may be varied from 1/16” - 3/8”

(1.5 - 10 mm) depending on job conditions and requirements. Dampen Xypex Concentrate surface ahead of application of Megamix I as required to maintain a damp but not glistening substrate (saturated surface dry condition).

STEP 7: In most situations, no moist curing of Xypex Megamix I is required but in rapid drying conditions, Megamix I should be allowed to fully set and then be misted periodically to keep moist for 24 hours. Backfill and place into service per Xypex coatings guidelines

Note 1: Schematic diagram shows Xypex application details only and does not depict standard requirements for waterstops or expansion joints. Inclusion, type and position of waterstops are at the discretion of the designer. Expanding waterstops may be placed on the slurry coat after it has dried or before application. Slurry coat may only be applied over waterstop if approved by waterstop manufacturer.

Note 2: Schematic drawing shows Xypex coating application. Specifier may consider the alternative use of Xypex dry shake (DS-Series) or Xypex additive (Admix C-Series). Refer to Xypex Standard Specifications for more information.

CMU BLOCK WALL – BELOW GRADE – INTERIOR APPLICATION

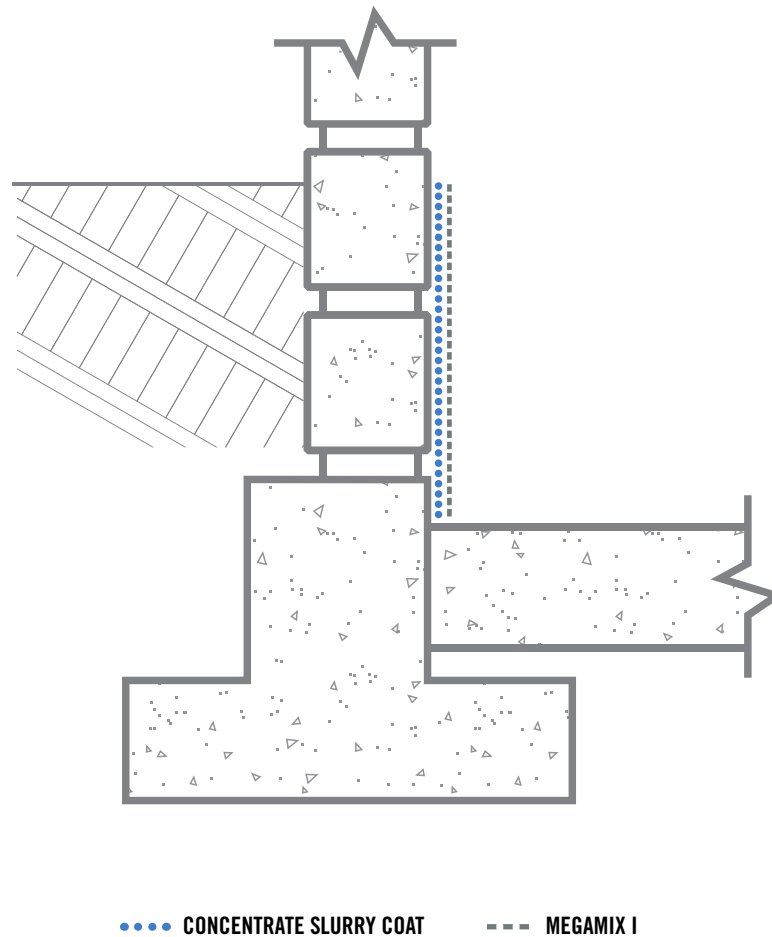

For information regarding CMU repair and remediation see Xypex Method Statement “Waterproofing of CMU/Concrete Block Walls” (Section 1.3, p. 4-5) or contact Xypex Technical Services for more information.

STEP 1: Thoroughly profile, clean and saturate the inside surface of all CMU block walls as well as any concrete surfaces that will receive Xypex coatings. Surfaces to have a “tooth and suction” ICRI CSP-3 profile and be fully saturated with no glistening water on the surface.

STEP 2: Apply one coat of Xypex Concentrate at the rate of 2.0 lb./sq.yd. (1.0 kg/m²) to all CMU block and concrete. Allow Xypex Concentrate coating to set and harden for between 12 hours and 24 hours (no more than 48 hours). During this time, moist cure coating per Xypex product data sheet.

STEP 3: Apply one coat of Megamix I over top of Xypex Concentrate coated CMU only. Apply Megamix I at a thickness of 1/8” (3 mm) or 11.25 lb./sq.yd. (5.6 kg/m²). Thickness of top coating may be varied from 1/16” - 3/8” (1.5 - 10 mm) depending on job conditions and requirements. Dampen Xypex Concentrate surface ahead of

application of Megamix I as required to maintain a damp but not glistening substrate (saturated surface dry condition).

STEP 4: In most situations, no moist curing of Xypex Megamix I is required but in rapid drying conditions, Megamix I should be allowed to fully set and then be misted periodically to keep moist for 24 hours.

Note 1: Schematic diagram shows Xypex application details only and does not depict standard requirements for waterstops or expansion joints. Inclusion, type and position of waterstops are at the discretion of the designer. Expanding waterstops may be placed on the slurry coat after it has dried or before application. Slurry coat may only be applied over waterstop if approved by waterstop manufacturer.

Note 2: Schematic drawing shows Xypex coating application. Specifier may consider the alternative use of Xypex dry shake (DS-Series) or Xypex additive (Admix C-Series). Refer to Xypex Standard Specifications for more information.

CMU BLOCK WALL – ABOVE GRADE – EXTERIOR APPLICATION

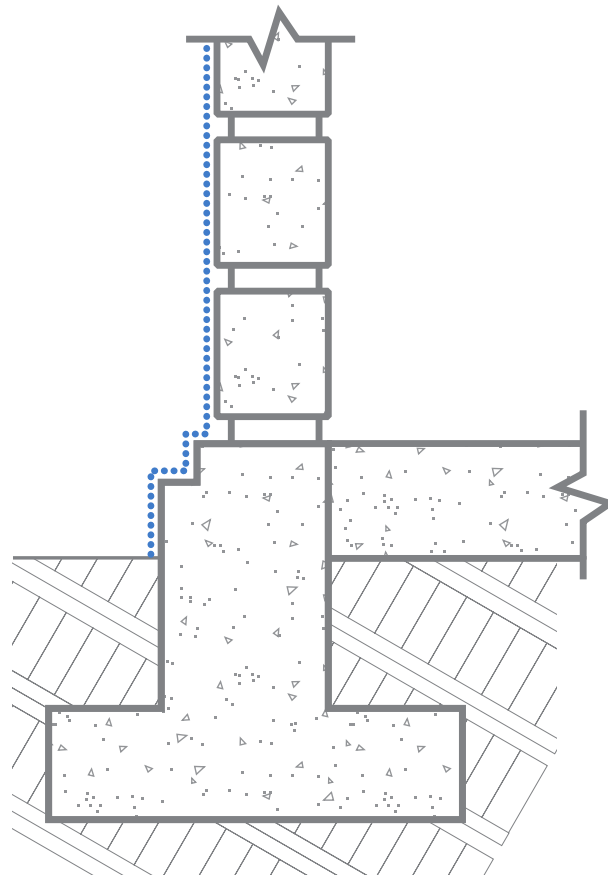

..... CONCENTRATE SLURRY COAT

STEP 1: Thoroughly profile, clean and saturate the outside surface of all CMU block walls as well as any concrete surfaces that will receive Xypex coatings. Surfaces to have a “tooth and suction” ICRI CSP-3 profile and be fully saturated with no glistening water on the surface.

STEP 2: Apply one coat of Xypex Concentrate at the rate of 2.0 lb./sq.yd. (1.0 kg/m²) to all CMU block and concrete.

STEP 3: Cure by keeping coating moist by misting or fog spraying periodically with water for 2 - 3 days. Open to water contact as per Xypex coatings guidelines.

Note 1: Schematic diagram shows Xypex application details only and does not depict standard requirements for waterstops or expansion joints. Inclusion, type and position of waterstops are at the discretion of the designer. Expanding waterstops may be placed on the slurry coat after it has dried or before application. Slurry coat may only be applied over waterstop if approved by waterstop manufacturer.

Note 2: Schematic drawing shows Xypex coating application. Specifier may consider the alternative use of Xypex dry shake (DS-Series) or Xypex additive (Admix C-Series). Refer to Xypex Standard Specifications for more information.

ADMIX SCHEMATIC DRAWINGS

Section	Page
Standard Construction Joint Details	
Traffic Bearing Slabs	1
Non-Traffic Bearing Slabs & Walls	2
Wall onto Slab	3
Slab into Wall to Keep Water Out.....	4
Slab into Wall to Keep Water In.....	5
Standard Metal Pipe Detail	6
Concrete Wall & Slab	
Below Grade – Slab into Wall.....	7
Multi-level Concrete Wall & Slab	
Below Grade – Slab into Wall.....	8
Split Mat Slab	
Non-Aggressive Soils / Waters.....	9
Aggressive Soils / Waters	10
Retaining Wall	11
Parking Deck	12
Roof / Plaza Deck	13
Hydraulic Elevator Pit	14
Elevator Pit / Sump Pit	15
Planter	16
Tunnel	17
Swimming Pool	18
Sewage Clarifier	19
Wall with Kicker	20
Reservoir / Wet Well	21
Underground Vault / Dry Well	22
Precast Concrete Manhole	23
Bridge	24

STANDARD CONST. JOINT DETAILS – TRAFFIC BEARING SLABS

Not subject to hydrostatic pressure

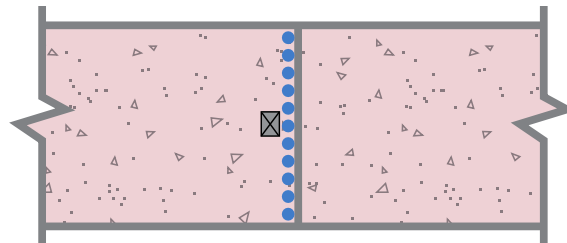

Subject to hydrostatic pressure

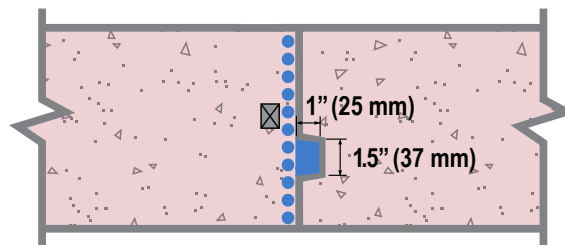

..... **CONCENTRATE SLURRY COAT**
 ■ **CONCENTRATE DRY-PAC**
 □ **ADMIX**
 ⊗ **WATERSTOP**

STEP 1: On the bulkhead formwork modify the forms to create a linear groove in the finished concrete surface. The linear groove is to be included at all construction joints. The linear groove is to be 1½” (37 mm) high by 1” (25 mm) deep. Position the linear groove to be closer to the wet side of the element.

STEP 2: Pour Xypex Admix treated concrete and cure in accordance with ACI, EN or other applicable international standard. Strip forms including formwork for linear groove.

STEP 3: Clean joints, including linear groove, thoroughly. Apply Xypex Concentrate slurry to linear groove at the rate of 1.5 lb./sq.yd. (0.8 kg/m²). Fill linear groove with Xypex Concentrate Dry-Pac and pack tightly to create the Xypex “sealing strip”.

STEP 4: Apply Xypex Concentrate slurry to joint surface, including over the sealing strip, at the rate of 2.0 lb./sq.yd. (1.0 kg/m²).

Note 1: Schematic diagram shows Xypex application and waterstops. Inclusion, type and position of waterstops and expansion joints are at the discretion of the designer. Expanding waterstops may be placed on the slurry coat after it has dried or before application. Slurry coat may only be applied over waterstop if approved by waterstop manufacturer.

Note 2: Keyways may be incorporated into the joint design at the discretion of the designer.

Note 3: Schematic drawing shows Xypex Admix application. Specifier may consider the alternative use of Xypex dry shake (DS-Series) or Xypex coatings, where applicable. Refer to Xypex Standard Specifications for more information.

STANDARD CONST. JOINT DETAILS – NON-TRAFFIC BEARING SLAB & WALLS

Not subject to hydrostatic pressure

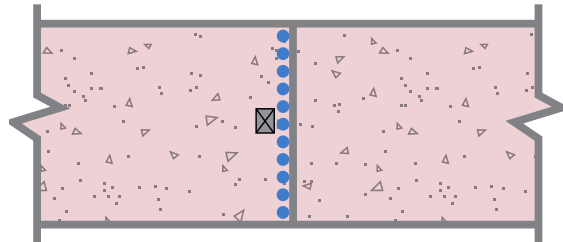

Subject to hydrostatic pressure

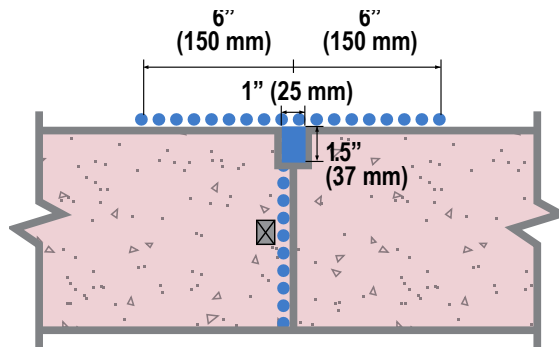

..... CONCENTRATE SLURRY COAT
 ■ CONCENTRATE DRY-PAC
 ■ ADMIX
 ⊗ WATERSTOP

STEP 1: Clean joint thoroughly. Apply Xypex Concentrate slurry to joint surfaces at the rate of 2.0 lb./sq.yd. (1.0 kg/m²).

STEP 2: On the side of the concrete element that will have direct water contact create a linear groove in the finished concrete surface. The linear groove is to be aligned with and included at all construction joints and to be 1" (25 mm) wide by 1½" (37 mm) deep. The linear groove may be offset to either side of the joint.

STEP 3: Pour Xypex Admix treated concrete and cure in accordance with ACI, EN or other applicable international standard. Strip forms including formwork for linear groove.

STEP 4: Clean linear groove thoroughly. Apply Xypex Concentrate slurry to linear groove at the rate of 1.5 lb./sq.yd. (0.8 kg/m²). Fill linear groove with Xypex Concentrate Dry-Pac and pack tightly to create the Xypex "sealing strip".

STEP 5: Apply Xypex Concentrate slurry coat at 1.5 lb./sq.yd. (0.8 kg/m²) over sealing strip and extending to 6" (150 mm) on either side. Cure for 48 - 72 hours in accordance with normal Xypex coatings curing procedures.

Note 1: Schematic diagram shows Xypex application and waterstops. Inclusion, type and position of waterstops and expansion joints are at the discretion of the designer. Expanding waterstops may be placed on the slurry coat after it has dried or before application. Slurry coat may only be applied over waterstop if approved by waterstop manufacturer.

Note 2: Keyways may be incorporated into the joint design at the discretion of the designer.

Note 3: Schematic drawing shows Xypex Admix application. Specifier may consider the alternative use of Xypex dry shake (DS-Series) or Xypex coatings, where applicable. Refer to Xypex Standard Specifications for more information.

STANDARD CONST. JOINT DETAILS – WALL ONTO SLAB

Not subject to hydrostatic pressure

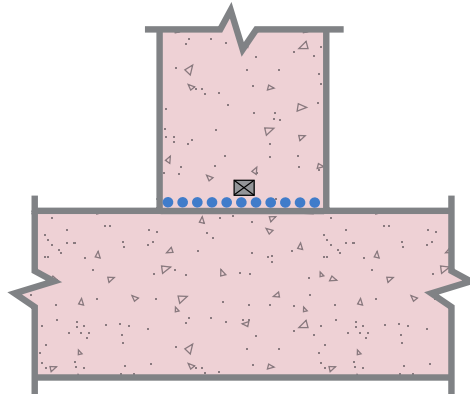

Subject to hydrostatic pressure

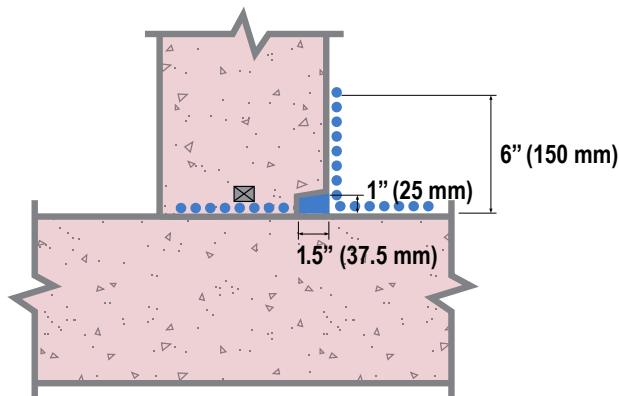

..... CONCENTRATE SLURRY COAT ■ CONCENTRATE DRY-PAC ■ ADMIX ☒ WATERSTOP

STEP 1: Clean joint thoroughly. Apply Xypex Concentrate slurry to joint surface at the rate of 2.0 lb./sq.yd. (1.0 kg/m²).

STEP 2: On the side of the concrete element that will have direct water contact modify the formwork to create a linear groove in the finished concrete surface. The linear groove is to be aligned with the wall to slab joint and is to be 1" (25 mm) high by 1½" (37 mm) deep.

STEP 3: Pour Xypex Admix treated concrete and cure in accordance with ACI, EN or other applicable international standard. Strip forms including formwork for linear groove.

STEP 4: Clean linear groove thoroughly. Apply Xypex Concentrate slurry to linear groove at the rate of 1.5 lb./sq.yd. (0.8 kg/m²). Fill linear groove with Xypex Concentrate Dry-Pac and pack tightly to create the Xypex "sealing strip".

STEP 5: Apply Xypex Concentrate slurry coat at 1.5 lb./sq.yd. (0.8 kg/m²) over sealing strip and extending to 6" (150 mm) on either side. Cure for 48 - 72 hours in accordance with normal Xypex coatings curing procedures.

Note 1: Schematic diagram shows Xypex application and waterstops. Inclusion, type and position of waterstops and expansion joints are at the discretion of the designer. Expanding waterstops may be placed on the slurry coat after it has dried or before application. Slurry coat may only be applied over waterstop if approved by waterstop manufacturer.

Note 2: Keyways may be incorporated into the joint design at the discretion of the designer.

Note 3: Schematic drawing shows Xypex Admix application. Specifier may consider the alternative use of Xypex dry shake (DS-Series) or Xypex coatings, where applicable. Refer to Xypex Standard Specifications for more information.

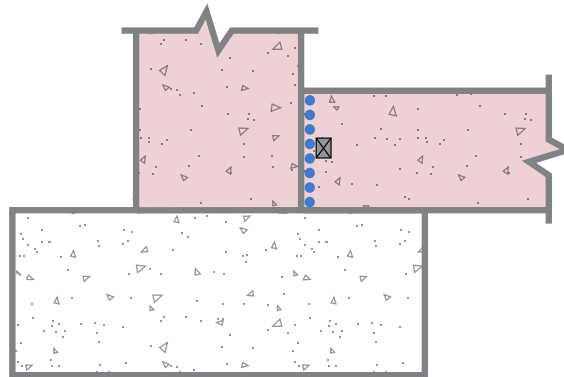
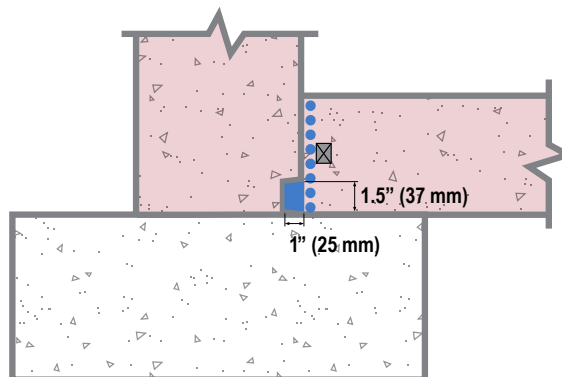
STANDARD CONST. JOINT DETAILS – SLAB INTO WALL TO KEEP WATER OUT
Not subject to hydrostatic pressure

Subject to hydrostatic pressure

●●● CONCENTRATE SLURRY COAT
 ■ CONCENTRATE DRY-PAC
 ■ ADMIX
 ⊗ WATERSTOP

STEP 1: Clean joint thoroughly. Apply Xypex Concentrate slurry to joint surface at the rate of 2.0 lb./sq.yd. (1.0 kg/m²).

STEP 2: Where the slab will contact the wall modify the wall forms to create a linear groove in the finished concrete surface. The linear groove is to be aligned with the bottom of the slab and is to be 1½" (37 mm) high by 1" (25 mm) deep.

STEP 3: Pour Xypex Admix treated concrete and cure in accordance with AC, EN or other applicable international standard. Strip forms including formwork for linear groove.

STEP 4: Clean joint including linear groove thoroughly. Apply Xypex Concentrate slurry to the linear groove at the rate of 1.5 lb./sq.yd. (0.8 kg/m²). Fill linear groove with Xypex Concentrate Dry-Pac and pack tightly to create the Xypex "sealing strip".

STEP 5: Apply slurry of Xypex Concentrate at 2.0 lb./sq.yd. (1.0 kg/m²) over sealing strip and extending to the full area of contact with the slab.

STEP 6: Pour slab as per Step 3.

Note 1: Schematic diagram shows Xypex application and waterstops. Inclusion, type and position of waterstops and expansion joints are at the discretion of the designer. Expanding waterstops may be placed on the slurry coat after it has dried or before application. Slurry coat may only be applied over waterstop if approved by waterstop manufacturer.

Note 2: Keyways may be incorporated into the joint design at the discretion of the designer.

Note 3: Xypex Admix may be considered for footings to protect the concrete and thus extend the service life of the structure.

Note 4: Schematic drawing shows Xypex Admix application. Specifier may consider the alternative use of Xypex dry shake (DS-Series) or Xypex coatings, where applicable. Refer to Xypex Standard Specifications for more information.

STANDARD CONST. JOINT DETAILS – SLAB INTO WALL TO KEEP WATER IN

Not subject to hydrostatic pressure

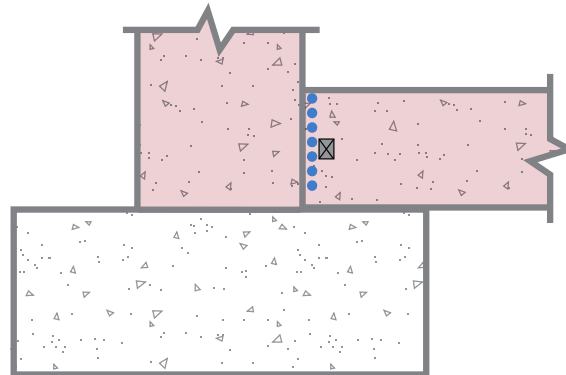

Subject to hydrostatic pressure

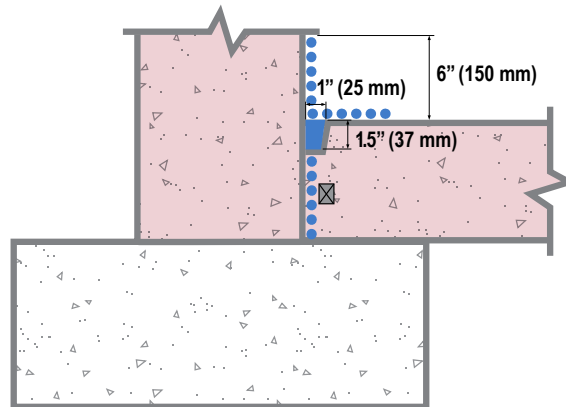

..... CONCENTRATE SLURRY COAT
 ■ CONCENTRATE DRY-PAC
 ■ ADMIX
 ⊗ WATERSTOP

STEP 1: Clean joint thoroughly. Apply Xypex Concentrate slurry to joint surface at the rate of 2.0 lb./sq.yd. (1.0 kg/m²).

STEP 2: Where the slab will contact the wall, create a linear groove in the finished concrete surface of the slab. The linear groove is to be 1" (35 mm) wide by 1½" (37 mm) deep.

STEP 3: Pour Xypex Admix treated concrete and cure in accordance with ACI, EN or other applicable international standard. Strip forms including formwork for linear groove.

STEP 4: Clean linear groove thoroughly. Apply Xypex Concentrate slurry to the linear groove at the rate of 1.5 lb./sq.yd. (0.8 kg/m²). Fill linear groove with Xypex Concentrate Dry-Pac and pack tightly to create the Xypex "sealing strip".

STEP 5: Apply slurry of Xypex Concentrate at 1.5 lb./sq.yd. (0.8 kg/m²) over sealing strip and extending to 6" (150 mm) on either side. Cure for 48 - 72 hours in accordance with normal Xypex coatings curing procedures.

Note 1: Schematic diagram shows Xypex application and waterstops. Inclusion, type and position of waterstops and expansion joints are at the discretion of the designer. Expanding waterstops may be placed on the slurry coat after it has dried or before application. Slurry coat may only be applied over waterstop if approved by waterstop manufacturer.

Note 2: Keyways may be incorporated into the joint design at the discretion of the designer.

Note 3: Xypex Admix may be considered for footings to protect the concrete and thus extend the service life of the structure.

Note 4: Schematic drawing shows Xypex Admix application. Specifier may consider the alternative use of Xypex dry shake (DS-Series) or Xypex coatings, where applicable. Refer to Xypex Standard Specifications for more information.

STANDARD METAL PIPE DETAIL

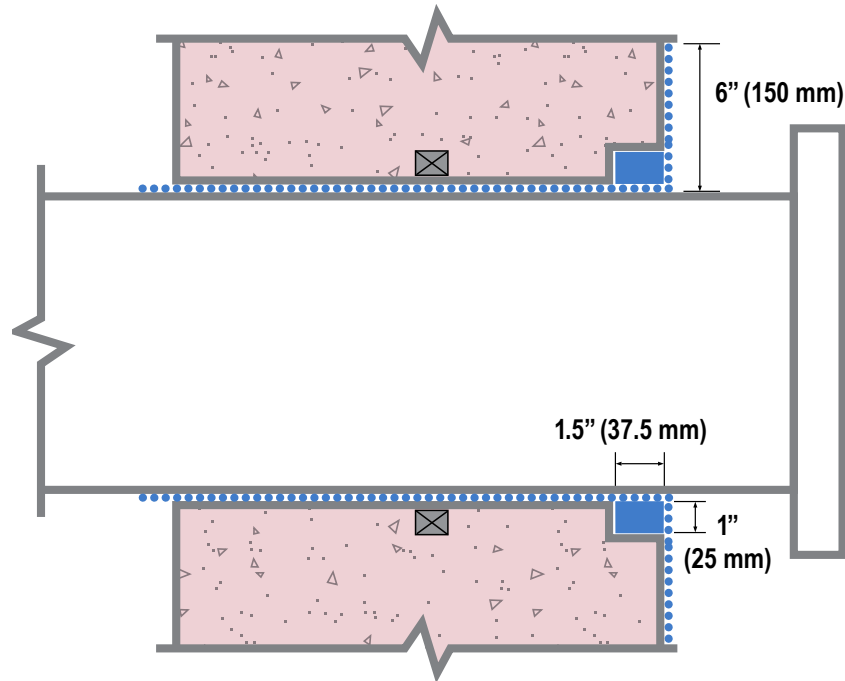

..... CONCENTRATE SLURRY COAT ■ CONCENTRATE DRY-PAC ■ ADMIX ⊗ WATERSTOP

STEP 1: Clean outside surface of pipe thoroughly and roughen with wire brush or sandpaper. Apply Xypex Concentrate Slurry coat to pipe surface at the rate of 2.0 lb./sq.yd. (1.0 kg/m²).

STEP 2: On water side modify the forms around the pipe to create a linear groove in the finished concrete surface. The linear groove is to be 1" (25 mm) high by 1½" (37 mm) deep and is to fully encircle the pipe.

STEP 3: Pour Xypex Admix treated concrete and cure in accordance with ACI, EN or other applicable international standard. Strip forms including formwork for linear groove.

STEP 4: Clean linear groove thoroughly. Apply Xypex Concentrate slurry to the linear groove at the rate of 1.5 lb./sq.yd. (0.8 kg/m²). Fill linear groove with Xypex Concentrate Dry-Pac and pack tightly to create the Xypex "sealing strip".

STEP 5: Apply slurry of Xypex Concentrate at 1.5 lb./sq.yd. (0.8 kg/m²) over sealing strip and extending to 6" (150 mm) from pipe. Cure for 48 - 72 hours in accordance with normal Xypex coatings curing procedures.

Note 1: Schematic diagram shows Xypex application and waterstops. Inclusion, type and position of waterstops and expansion joints are at the discretion of the designer. Expanding waterstops may be placed on the slurry coat after it has dried or before application. Slurry coat may only be applied over waterstop if approved by waterstop manufacturer.

Note 2: Schematic drawing shows Xypex Admix application. Specifier may consider the alternative use of Xypex dry shake (DS-Series) or Xypex coatings, where applicable. Refer to Xypex Standard Specifications for more information.

CONCRETE WALL & SLAB – BELOW GRADE – SLAB INTO WALL

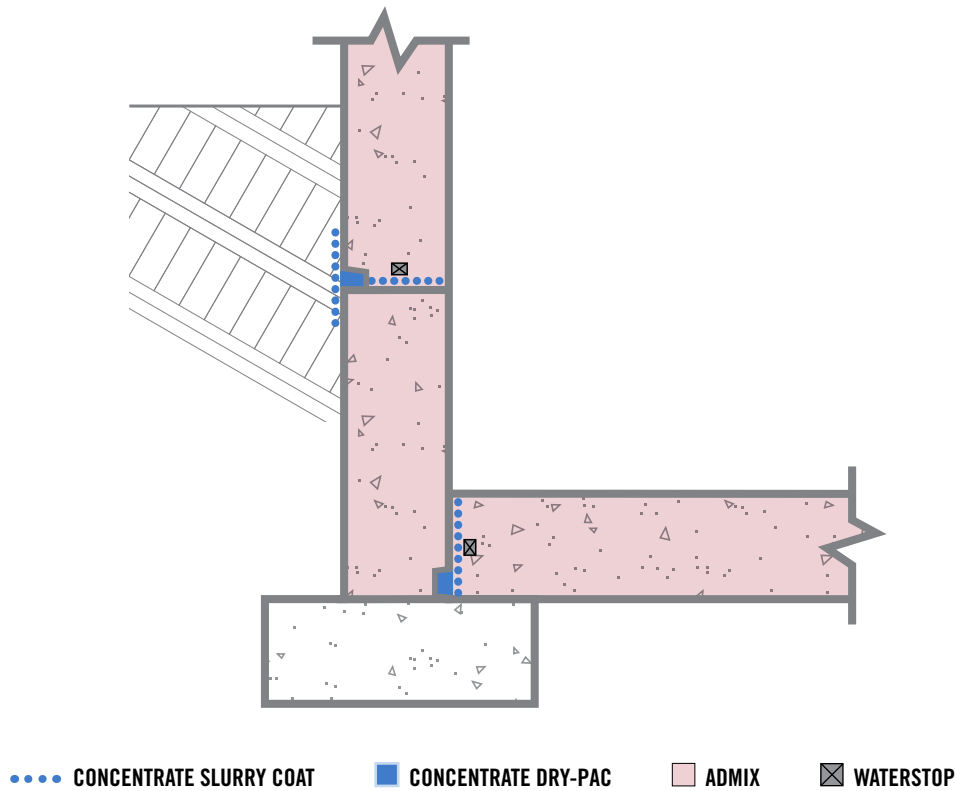

STEP 1: Where the slab will contact the wall modify the forms to create a linear groove in the finished concrete surface of the wall. The linear groove is to be aligned with the bottom of the slab and is to be 1½” (37 mm) high by 1” (25 mm) deep.

STEP 2: Pour Xypex Admix treated concrete and cure in accordance with ACI, EN or other applicable international standard. Strip forms including formwork for linear groove.

STEP 3: Clean joint including linear groove thoroughly. Apply Xypex Concentrate slurry to the linear groove at the rate of 1.5 lb./sq.yd. (0.8 kg/m²). Fill linear groove with Xypex Concentrate Dry-Pac and pack tightly to create the Xypex “sealing strip”.

STEP 4: Clean joint thoroughly. Apply slurry of Xypex Concentrate at 2.0 lb./ sq.yd. (1.0 kg/m²) over sealing strip and extending to the full area of contact with the slab.

STEP 5: Pour slab as per Step 2.

STEP 6: Clean wall joint thoroughly. Apply Xypex Concentrate slurry to joint surface at the rate of 2.0 lb./sq.yd. (1.0 kg/m²).

STEP 7: On the side of the concrete element that will have direct water contact modify, the forms to create a linear groove in the finished concrete surface. The linear groove is to be aligned with and included at all construction joints and to be 1” (25 mm) high by 1½” (37 mm) deep.

STEP 8: Pour wall as per Step 2. Strip forms including formwork for linear groove.

STEP 9: Clean linear groove thoroughly. Apply Xypex Concentrate slurry to linear groove at the rate of 1.5 lb./sq.yd. (0.8 kg/m²). Fill linear groove with Xypex Concentrate Dry-Pac and pack tightly to create the Xypex “sealing strip”.

STEP 10: Apply slurry of Xypex Concentrate at 1.5 lb./sq.yd. (0.8 kg/m²) over sealing strip and extending to 6” (150 mm) on either side. Cure for 48 - 72 hours in accordance with normal Xypex coatings curing procedures.

Note 1: Schematic diagram shows Xypex application and waterstops. Inclusion, type and position of waterstops and expansion joints are at the discretion of the designer. Expanding waterstops may be placed on the slurry coat after it has dried or before application. Slurry coat may only be applied over waterstop if approved by waterstop manufacturer.

Note 2: Keyways may be incorporated into the joint design at the discretion of the designer.

Note 3: Xypex Admix may be considered for footings to protect the concrete and thus extend the service life of the structure.

Note 4: Schematic drawing shows Xypex Admix application. Specifier may consider the alternative use of Xypex dry shake (DS-Series) or Xypex coatings, where applicable. Refer to Xypex Standard Specifications for more information.

MULTI-LEVEL CONCRETE WALL & SLAB – BELOW GRADE – SLAB INTO WALL

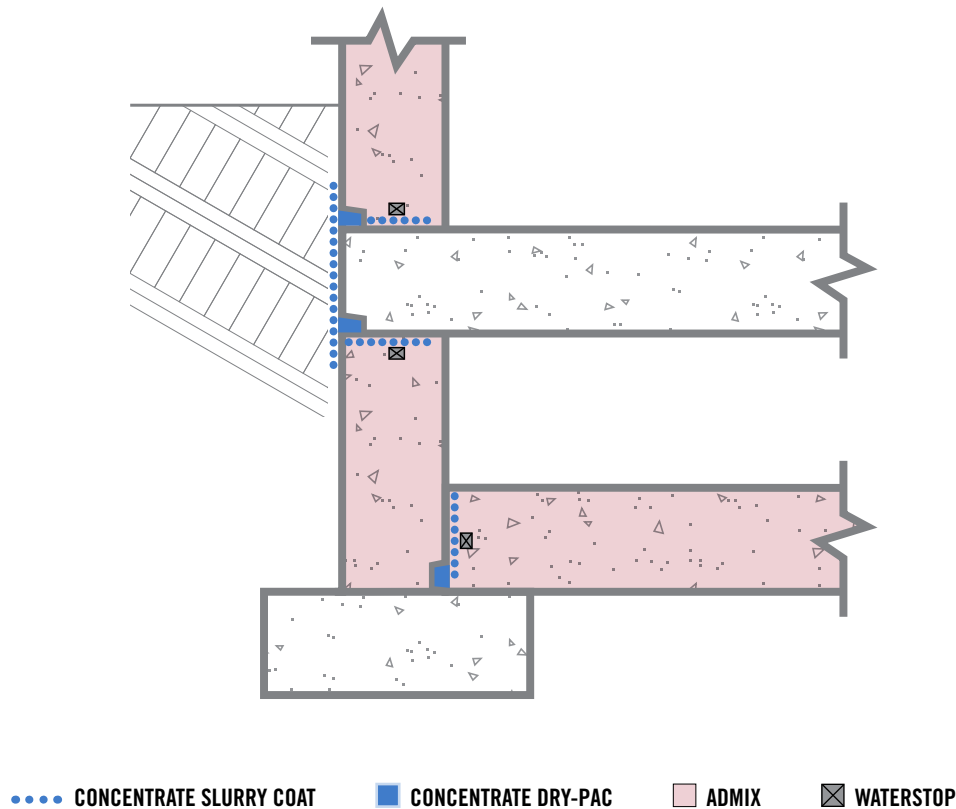

STEP 1: Where the slab will contact the wall modify the forms to create a linear groove in the finished concrete surface of the wall. The linear groove is to be aligned with the bottom of the slab and is to be 1½” (37 mm) high by 1” (25 mm) deep.

STEP 2: Pour Xypex Admix treated concrete and cure in accordance with ACI, EN or other applicable international standard. Strip forms including formwork for linear groove.

STEP 3: Clean joint including linear groove thoroughly. Apply Xypex Concentrate slurry to the linear groove at the rate of 1.5 lb./sq.yd. (0.8 kg/m²). Fill linear groove with Xypex Concentrate Dry-Pac and pack tightly to create the Xypex “sealing strip”.

STEP 4: Apply slurry of Xypex Concentrate at 2.0 lb./sq.yd. (1.0 kg/m²) over sealing strip and extending to the full area of contact with the slab.

STEP 5: Pour bottom slab as per Step 2.

STEP 6: Modify the forms to create a linear groove in the exterior finished concrete surface at the suspended slab to wall joint. The linear groove is to be 1” (25 mm) high by 1½” (37 mm) deep.

STEP 7: Clean wall joint thoroughly. Apply Xypex Concentrate slurry to joint surface at the rate of 2.0 lb./sq.yd. (1.0 kg/m²).

STEP 8: Pour suspended slab as per Step 2 and strip forms including formwork for linear groove.

STEP 9: Clean joint including linear groove thoroughly. Apply Xypex Concentrate slurry to the linear groove at the rate of 1.5 lb./sq.yd. (0.8 kg/m²). Fill linear groove with Xypex Concentrate Dry-Pac and pack tightly to create the Xypex “sealing strip”.

STEP 10: Apply slurry of Xypex Concentrate at 1.5 lb./sq.yd. (0.8 kg/m²) over the exterior vertical surface of the suspended slab and the sealing strips and extending to 6” (150 mm) on either side. Cure for 48 - 72 hours in accordance with normal Xypex coatings curing procedures.

Note 1: Schematic diagram shows Xypex application and waterstops. Inclusion, type and position of waterstops and expansion joints are at the discretion of the designer. Expanding waterstops may be placed on the slurry coat after it has dried or before application. Slurry coat may only be applied over waterstop if approved by waterstop manufacturer.

Note 2: Keyways may be incorporated into the joint design at the discretion of the designer.

Note 3: Xypex Admix may be considered for footings to protect the concrete and thus extend the service life of the structure.

Note 4: Schematic drawing shows Xypex Admix application. Specifier may consider the alternative use of Xypex dry shake (DS-Series) or Xypex coatings, where applicable. Refer to Xypex Standard Specifications for more information.

SPLIT MAT SLAB – NON-AGGRESSIVE SOILS / WATERS

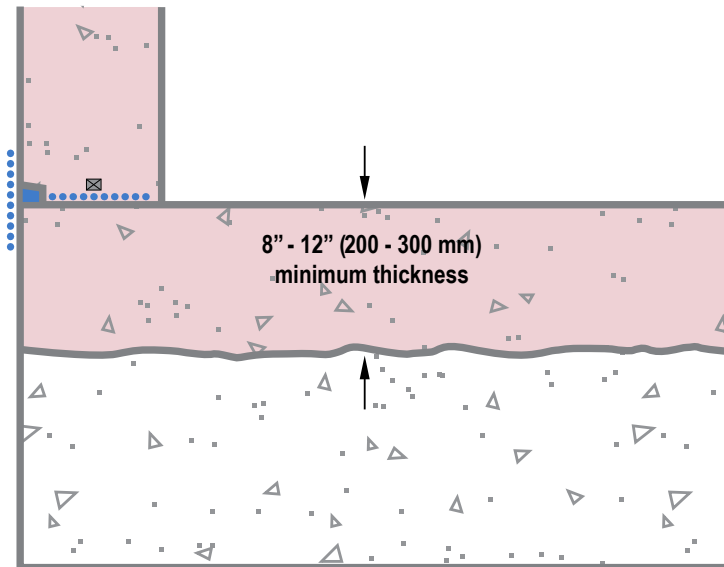

..... CONCENTRATE SLURRY COAT
 ■ CONCENTRATE DRY-PAC
 ■ ADMIX
 WATERSTOP

STEP 1: Pour Xypex Admix treated concrete to a minimum depth of 8" (200 mm) to 12" (300 mm) as the final lift of the slab. Ensure that Xypex Admix treated concrete is poured prior to a cold joint forming and vibrate the layers together. Finish the slab and cure in accordance with ACI, EN or other applicable international standard.

STEP 2: Clean joint thoroughly. Apply Xypex Concentrate slurry to joint surface at the rate of 2.0 lb./sq.yd. (1.0 kg/m²).

STEP 3: Where the slab will contact the wall modify the wall forms to create a linear groove in the finished concrete surface. The linear groove is to be aligned with the top of the slab and is to be 1" (25 mm) high by 1½" (37 mm) deep.

STEP 4: Pour Xypex Admix treated concrete and cure in accordance with ACI, EN or other applicable international standard. Strip forms including formwork for linear groove.

STEP 5: Clean linear groove thoroughly. Apply Xypex Concentrate slurry to the linear groove at the rate of 1.5 lb./sq.yd. (0.8 kg/m²). Fill linear groove with Xypex Concentrate Dry-Pac and pack tightly to create the Xypex "sealing strip".

STEP 6: Apply slurry of Xypex Concentrate at 1.5 lb./sq.yd. (0.8 kg/m²) over sealing strip and extending to 6" (150 mm) on either side. Cure for 48 - 72 hours in accordance with normal Xypex coatings curing procedures.

Note 1: Schematic diagram shows Xypex installation and waterstops. Inclusion, type and position of waterstops and expansion joints are at the discretion of the designer. Expanding waterstops may be placed on the slurry coat after it has dried or before application. Slurry coat may only be applied over waterstop if approved by waterstop manufacturer.

Note 2: Keyways may be incorporated into the joint design at the discretion of the designer.

Note 3: Schematic drawing shows Xypex Admix application. Specifier may consider the alternative use of Xypex dry shake (DS-Series) or Xypex coatings, where applicable. Refer to Xypex Standard Specifications for more information.

SPLIT MAT SLAB – AGGRESSIVE SOILS / WATERS

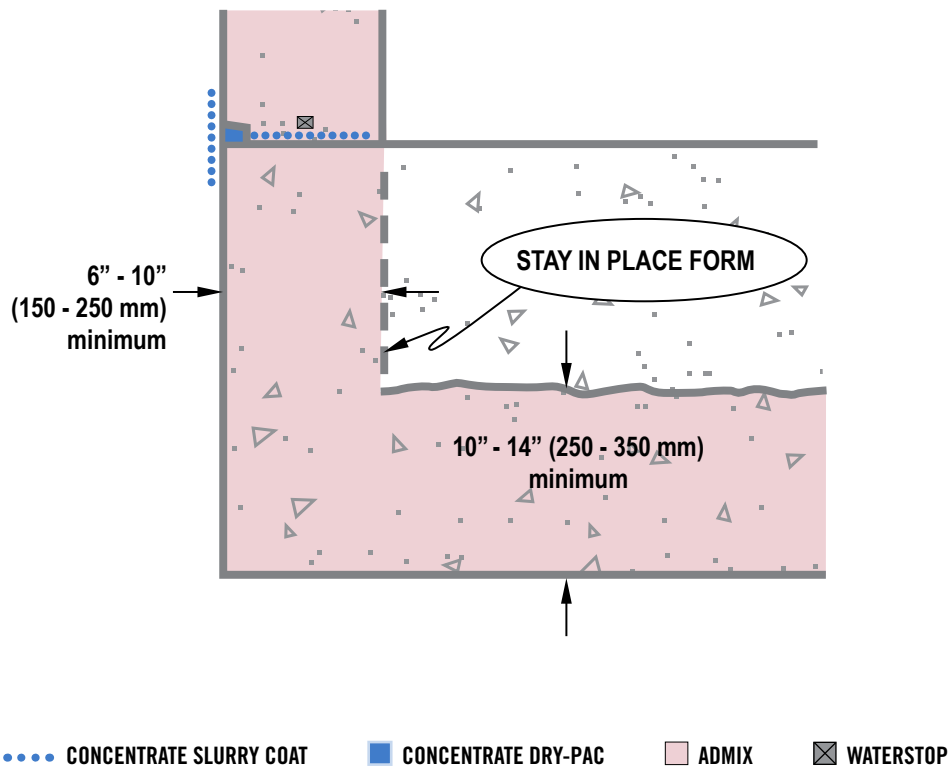

STEP 1: Install stay in place forming assembly as shown to create a shell of Xypex Admix treated concrete around the entire outside area of the mat slab. The shell thickness is to be a minimum of 6" (150 mm) to 10" (250 mm).

STEP 2: Pour Xypex Admix treated concrete to a minimum depth of 10" (250 mm) to 14" (350 mm) into the bottom of the slab. Fill the shell as shown. Before the Xypex Admix treated concrete has reached initial set, pour the remainder of the concrete (not treated with Xypex Admix) completing the pour and cure in accordance with ACI, EN or other applicable international standard.

STEP 3: Clean joint thoroughly. Apply Xypex Concentrate slurry to joint surface at the rate of 2.0 lb./sq.yd. (1.0 kg/m²).

STEP 4: Where the slab will contact the wall modify the wall forms to create a linear groove in the finished concrete surface. The linear groove is to be aligned with the top of the slab and is to be 1" (25 mm) high by 1½" (37 mm) deep.

STEP 5: Pour Xypex Admix treated concrete and cure in accordance with ACI, EN or other applicable international standard. Strip forms including formwork for linear groove.

STEP 6: Clean linear groove thoroughly. Apply Xypex Concentrate slurry to the linear groove at the rate of 1.5

lb./sq.yd. (0.8 kg/m²). Fill linear groove with Xypex Concentrate Dry-Pac and pack tightly to create the Xypex "sealing strip".

STEP 7: Apply slurry of Xypex Concentrate at 1.5 lb./sq.yd. (0.8 kg/m²) over sealing strip and extending to 6" (150 mm) on either side. Cure for 48 - 72 hours in accordance with normal Xypex coatings curing procedures.

Note 1: Schematic diagram shows Xypex installation and waterstops. Inclusion, type and position of waterstops and expansion joints are at the discretion of the designer. Expanding waterstops may be placed on the slurry coat after it has dried or before application. Slurry coat may only be applied over waterstop if approved by waterstop manufacturer.

Note 2: Keyways may be incorporated into the joint design at the discretion of the designer.

Note 3: Stayform may be eliminated and Xypex Admix treated concrete mounded in the outside perimeter of the slab to create a shell. A minimum thickness of 6" (150 mm) to 10" (250 mm) of Xypex Admix treated concrete must be maintained in the shell wall.

Note 4: Schematic drawing shows Xypex Admix application. Specifier may consider the alternative use of Xypex coatings, where applicable. Refer to Xypex Standard Specifications for more information.

RETAINING WALL

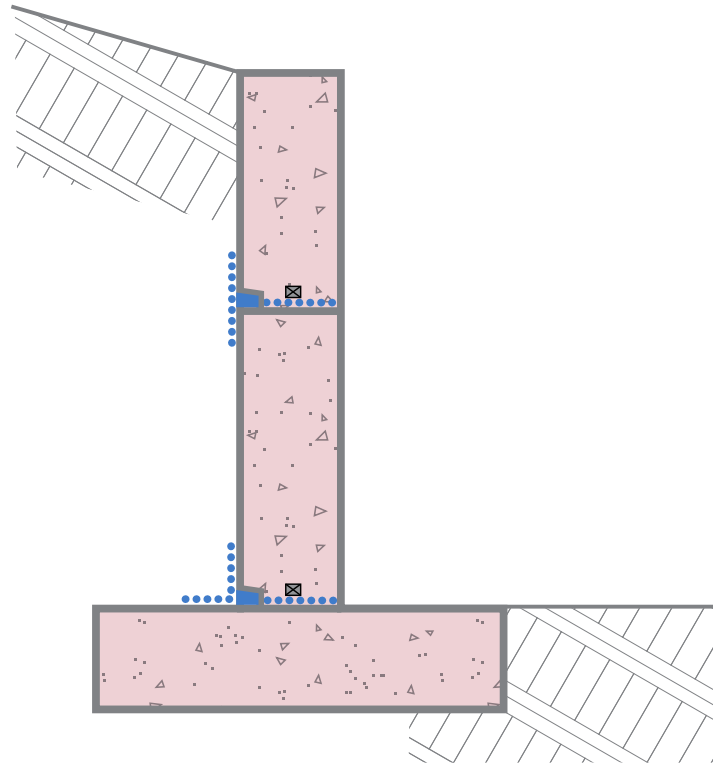

..... **CONCENTRATE SLURRY COAT**
 ■ **CONCENTRATE DRY-PAC**
 ■ **ADMIX**
 ⊠ **WATERSTOP**

STEP 1: Clean joint thoroughly. Apply Xypex Concentrate slurry to joint surfaces at the rate of 2.0 lb./sq.yd (1.0 kg/m²).

STEP 2: On the side of the concrete element that will have direct water contact modify the forms to create a linear groove in the finished concrete surface. The linear groove is to be aligned with and included at all construction joints and to be 1" (25 mm) high by 1½" (37 mm) deep.

STEP 3: Pour Xypex Admix treated concrete and cure in accordance with ACI, EN or other applicable international standard. Strip forms including formwork for linear groove.

STEP 4: Clean linear groove thoroughly. Apply Xypex Concentrate slurry to the linear groove at the rate of 1.5 lb./sq.yd. (0.8 kg/m²). Fill linear groove with Xypex Concentrate Dry-Pac and pack tightly to create the Xypex "sealing strip".

STEP 5: Apply one coat of Xypex Concentrate slurry at the rate of 1.5 lb./sq.yd. over the sealing strip and extending to 6" (150 mm) on either side. Cure for 48 - 72 hours in accordance with normal Xypex coatings curing procedures.

Note 1: Schematic diagram shows Xypex application and waterstops. Inclusion, type and position of waterstops and expansion joints are at the discretion of the designer. Expanding waterstops may be placed on the slurry coat after it has dried or before application. Slurry coat may only be applied over waterstop if approved by waterstop manufacturer.

Note 2: Keyways may be incorporated into the joint design at the discretion of the designer.

Note 3: Schematic drawing shows Xypex Admix application. Specifier may consider the alternative use of Xypex dry shake (DS-Series) or Xypex coatings, where applicable. Refer to Xypex Standard Specifications for more information.

PARKING DECK

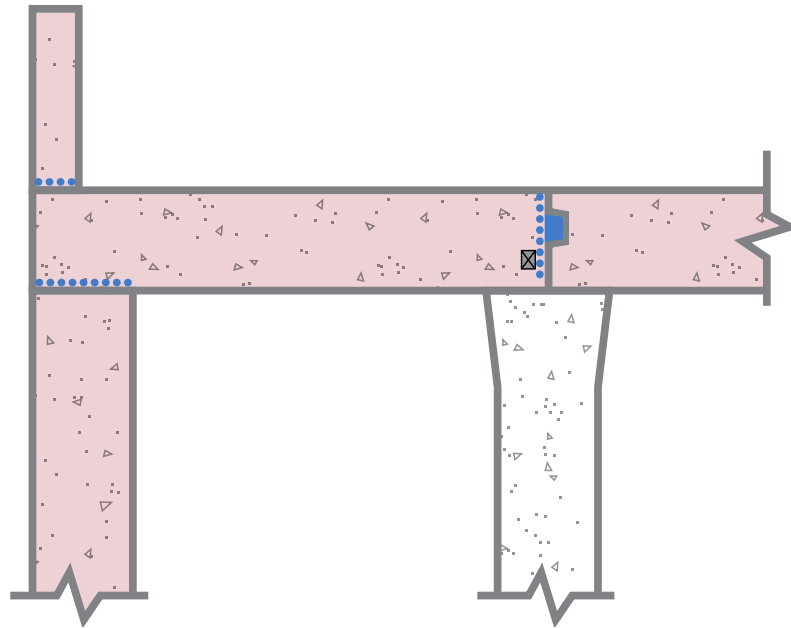

●●● CONCENTRATE SLURRY COAT
 ■ CONCENTRATE DRY-PAC
 □ ADMIX
 ⊠ WATERSTOP

STEP 1: Clean joint thoroughly. Apply Xypex Concentrate slurry to joint surfaces at the rate of 2.0 lb./sq.yd. (1.0 kg/m²).

STEP 2: On the bulkhead formwork modify the forms to create a linear groove in the finished concrete surface. The linear groove is to be included at all construction joints and to be 1½” (37 mm) high by 1” (25 mm) deep. Position the linear groove to be closer to the top side of the element.

STEP 3: Pour Xypex Admix treated concrete and cure in accordance with ACI, EN or other applicable international standard. Strip forms including formwork for linear groove.

STEP 4: Clean linear groove thoroughly. Apply Xypex Concentrate slurry to the linear groove at the rate of 1.5 lb./sq.yd. (0.8 kg/m²). Fill linear groove with Xypex Concentrate Dry-Pac and pack tightly to create the Xypex “sealing strip”.

STEP 5: Apply slurry of Xypex Concentrate at 2.0 lb./sq.yd. (1.0 kg/m²) over sealing strip and extending to the full area of contact with the slab.

Note 1: Parking decks are normally subject to variable live loads that may create movement in cracks beyond the ability of Xypex to heal. Consult your local Xypex Technical Services Representative.

Note 2: Schematic diagram shows Xypex application and waterstops. Inclusion, type and position of waterstops and expansion joints are at the discretion of the designer. Expanding waterstops may be placed on the slurry coat after it has dried or before application. Slurry coat may only be applied over waterstop if approved by waterstop manufacturer.

Note 3: Keyways may be incorporated into the joint design at the discretion of the designer.

Note 4: Schematic drawing shows Xypex Admix application. Specifier may consider the alternative use of Xypex dry shake (DS-Series) or Xypex coatings, where applicable. Refer to Xypex Standard Specifications for more information.

ROOF / PLAZA DECK

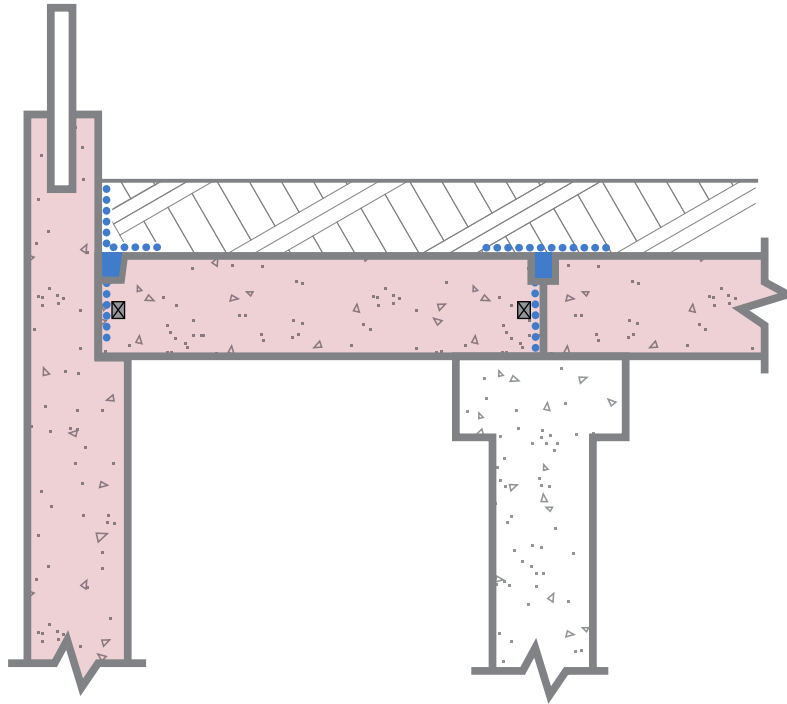

●●● CONCENTRATE SLURRY COAT
 ■ CONCENTRATE DRY-PAC
 ■ ADMIX
 X WATERSTOP

STEP 1: Clean joint thoroughly. Apply Xypex Concentrate slurry to joint surface at the rate of 2.0 lb./sq.yd. (1.0 kg/m²).

STEP 2: Pour Xypex Admix treated concrete and cure in accordance with ACI, EN or other applicable international standard.

STEP 3: On top side of the concrete slab create a linear groove in the finished concrete surface. The linear groove is to be aligned with and included at all construction joints and is to be 1" (25 mm) wide by 1½" (37 mm) deep. The linear groove may be offset to either side of the joint.

STEP 4: Clean linear groove thoroughly. Apply Xypex Concentrate slurry to the linear groove at the rate of 1.5 lb./sq.yd. (0.8 kg/m²). Fill linear groove with Xypex Concentrate Dry-Pac and pack tightly to create the Xypex "sealing strip".

STEP 5: Apply Xypex Concentrate slurry at the rate of 1.5 lb./sq.yd. (0.8 kg/m²) over sealing strip and extending to 6" (150 mm) on either side. Cure for 48 - 72 hours in accordance with normal Xypex coatings curing procedures.

Note 1: Roof / plaza decks can be subject to variable live loads that may create movement in cracks beyond the ability of Xypex to heal. Consult your local Xypex Technical Services Representative.

Note 2: Schematic diagram shows Xypex application and waterstops. Inclusion, type and position of waterstops and expansion joints are at the discretion of the designer. Expanding waterstops may be placed on the slurry coat after it has dried or before application. Slurry coat may only be applied over waterstop if approved by waterstop manufacturer.

Note 3: Keyways may be incorporated into the joint design at the discretion of the designer.

Note 4: Schematic drawing shows Xypex Admix application. Specifier may consider the alternative use of Xypex dry shake (DS-Series) or Xypex coatings, where applicable. Refer to Xypex Standard Specifications for more information.

HYDRAULIC ELEVATOR PIT

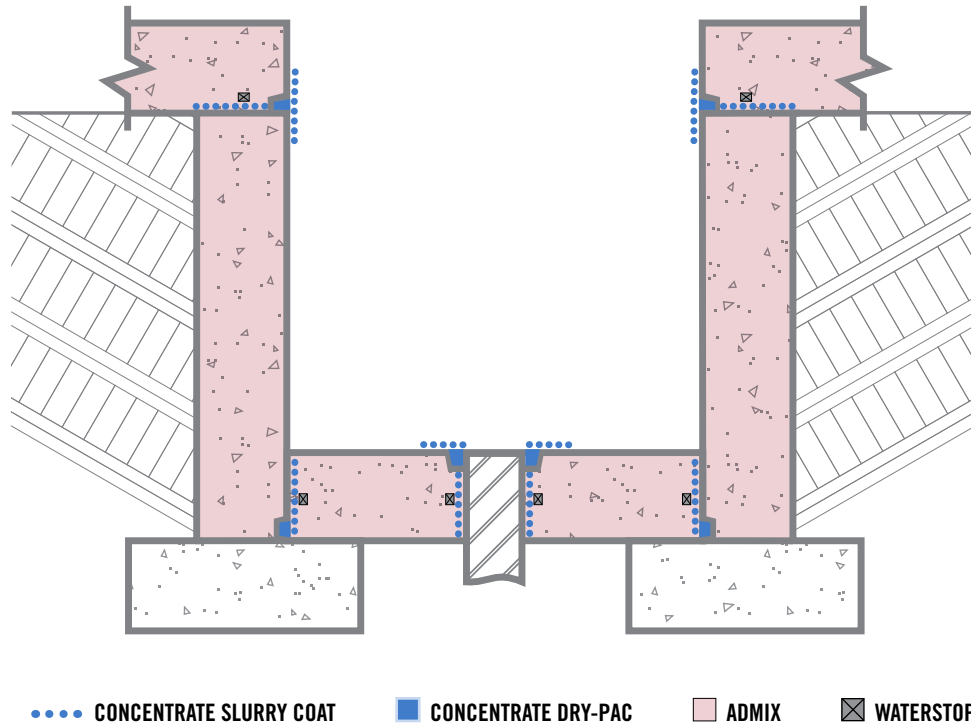

STEP 1: Where the slab will contact the wall modify the wall forms to create a linear groove in the finished concrete surface. The linear groove is to be aligned with the bottom of the slab and is to be 1½" (37 mm) high by 1" (25 mm) deep.

STEP 2: Pour Xypex Admix treated concrete and cure in accordance with ACI, EN or other applicable international standard. Strip forms including formwork for linear groove.

STEP 3: Clean linear groove thoroughly. Apply Xypex Concentrate slurry to the linear groove at the rate of 1.5 lb./sq.yd. (0.8 kg/m²). Fill linear groove with Xypex Concentrate Dry-Pac and pack tightly to create the Xypex "sealing strip".

STEP 4: Apply slurry of Xypex Concentrate at 2.0 lb./sq.yd. (1.0 kg/m²) over sealing strip and extending to the full area of contact with the slab.

STEP 5: Apply Xypex Concentrate slurry at a rate of 1.5 lb./sq.yd. (0.8 kg/m²) to the inground cylinder casing where the concrete slab will interface with the steel cylinder.

STEP 6: Pour bottom slab per Step 2. Tool around the inground cylinder to form a 1" (25 mm) wide by 1½" (37 mm) deep linear groove around the cylinder casing.

STEP 7: Clean joint thoroughly. Apply Xypex Concentrate slurry to joint surface at the rate of 2.0 lb./sq.yd. (1.0 kg/m²).

STEP 8: At the bottom of the upper slab to wall construction joint modify the forms to create a linear groove in the finished concrete surface. The linear groove is to be 1" (25 mm) high by 1½" (37 mm) deep.

STEP 9: Pour upper slab per Step 2 and strip forms.

STEP 10: Clean linear groove thoroughly. Apply Xypex Concentrate slurry to the linear groove at the rate of 1.5 lb./sq.yd. (0.8 kg/m²). Fill linear groove with Xypex Concentrate Dry-Pac and pack tightly to create the Xypex "sealing strip".

STEP 11: Apply Xypex Concentrate slurry at the rate of 1.5 lb./sq.yd. (0.8 kg/m²) over sealing strip and extending to 6" (150 mm) on either side. Cure for 48 - 72 hours in accordance with normal Xypex coatings curing procedures.

Note 1: Schematic diagram shows Xypex application and waterstops. Inclusion, type and position of waterstops and expansion joints are at the discretion of the designer. Expanding waterstops may be placed on the slurry coat after it has dried or before application. Slurry coat may only be applied over waterstop if approved by waterstop manufacturer.

Note 2: Keyways may be incorporated into the joint design at the discretion of the designer.

Note 3: Xypex Admix may be considered for footings to protect the concrete and thus extend the service life of the structure.

Note 4: Schematic drawing shows Xypex Admix application. Specifier may consider the alternative use of Xypex dry shake (DS-Series) or Xypex coatings, where applicable. Refer to Xypex Standard Specifications for more information.

ELEVATOR PIT / SUMP PIT

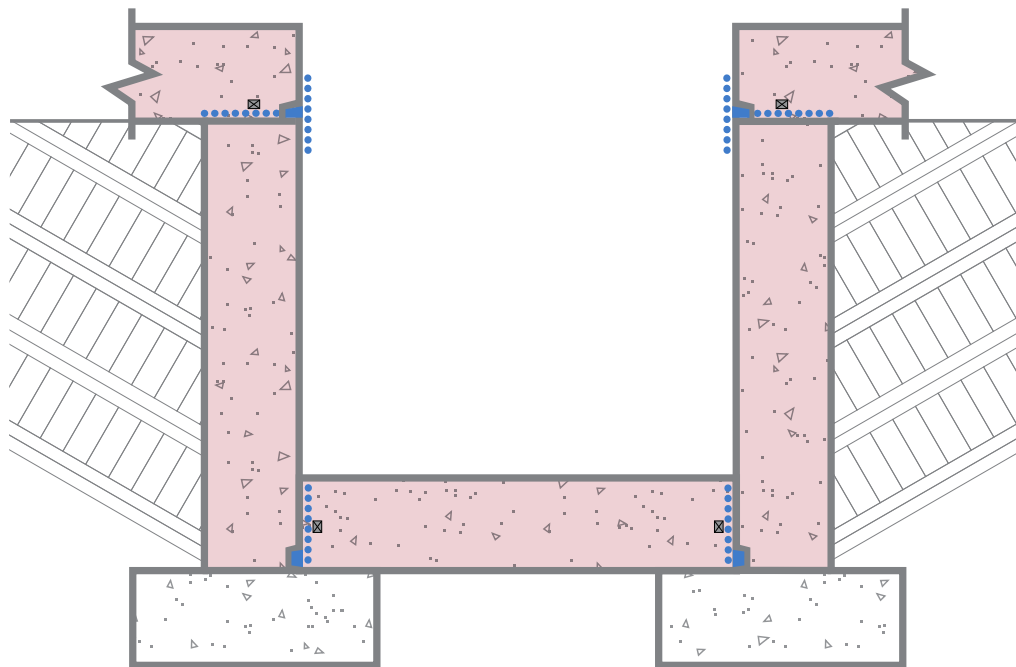

●●● CONCENTRATE SLURRY COAT
 ■ CONCENTRATE DRY-PAC
 ■ ADMIX
 ⊠ WATERSTOP

STEP 1: Where the bottom slab will contact the wall modify the wall forms to create a linear groove in the finished concrete surface. The linear groove is to be aligned with the bottom of the slab and is to be 1½" (37 mm) high by 1" (25 mm) deep.

STEP 2: Pour Xypex Admix treated concrete and cure in accordance with ACI, EN or other applicable international standard. Strip forms including formwork for linear groove.

STEP 3: Clean linear groove thoroughly. Apply Xypex Concentrate slurry to the linear groove at the rate of 1.5 lb./sq.yd. (0.8 kg/m²). Fill linear groove with Xypex Concentrate Dry-Pac and pack tightly to create the Xypex "sealing strip".

STEP 4: Apply slurry of Xypex Concentrate at 2.0 lb./sq.yd. (1.0 kg/m²) over sealing strip and extending to the full area of contact with the slab.

STEP 5: Pour bottom slab per Step 2.

STEP 6: At the bottom of the upper slab to wall construction joint modify the forms to create a linear groove in the finished concrete surface. The linear groove is to be 1" (25 mm) high by 1½" (37 mm) deep.

STEP 7: Pour upper slab per Step 2 and strip forms.

STEP 8: Clean linear groove thoroughly. Apply Xypex Concentrate slurry to the linear groove at the rate of 1.5 lb./sq.yd. (0.8 kg/m²). Fill linear groove with Xypex Concentrate Dry-Pac and pack tightly to create the Xypex "sealing strip".

STEP 9: Apply Xypex Concentrate slurry at the rate of 1.5 lb./sq.yd. (0.8 kg/m²) over sealing strip and extending to 6" (150 mm) on either side. Cure for 48 - 72 hours in accordance with normal Xypex coatings curing procedures.

Note 1: Schematic diagram shows Xypex application and waterstops. Inclusion, type and position of waterstops and expansion joints are at the discretion of the designer. Expanding waterstops may be placed on the slurry coat after it has dried or before application. Slurry coat may only be applied over waterstop if approved by waterstop manufacturer.

Note 2: Keyways may be incorporated into the joint design at the discretion of the designer.

Note 3: Xypex Admix may be considered for footings to protect the concrete and thus extend the service life of the structure.

Note 4: Schematic drawing shows Xypex Admix application. Specifier may consider the alternative use of Xypex dry shake (DS-Series) or Xypex coatings, where applicable. Refer to Xypex Standard Specifications for more information.

PLANTER

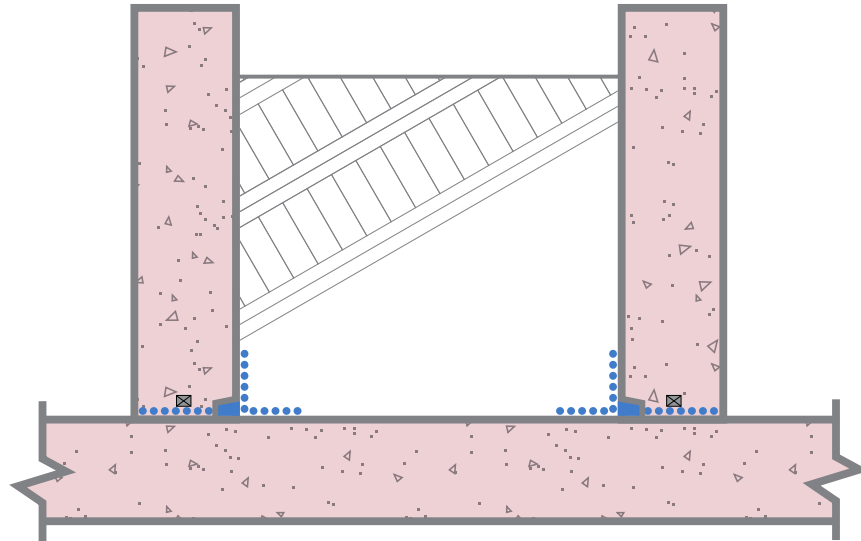

●●●● CONCENTRATE SLURRY COAT
 ■ CONCENTRATE DRY-PAC
 ■ ADMIX
 ⊠ WATERSTOP

STEP 1: Clean joint thoroughly. Apply Xypex Concentrate slurry to joint surface at the rate of 2.0 lb./sq.yd. (1.0 kg/m²).

STEP 2: On the inside of the planter, modify the forms to create a linear groove in the finished concrete surface. The linear groove is to be aligned with and included at all construction joints and to be 1" (25 mm) high by 1½" (37 mm) deep.

STEP 3: Pour Xypex Admix treated concrete and cure in accordance with ACI, EN or other applicable international standard. Strip forms including formwork for linear groove.

STEP 4: Clean linear groove thoroughly. Apply Xypex Concentrate slurry to the linear groove at the rate of 1.5 lb./sq.yd. (0.8 kg/m²). Fill linear groove with Xypex Concentrate Dry-Pac and pack tightly to create the Xypex "sealing strip".

STEP 5: Apply Xypex Concentrate slurry coat at 1.5 lb./sq.yd. (0.8 kg/m²) over sealing strip and extending to 6" (150 mm) on either side. Cure for 48 - 72 hours in accordance with normal Xypex coatings curing procedures.

Note 1: Schematic diagram shows Xypex application and waterstops. Inclusion, type and position of waterstops and expansion joints are at the discretion of the designer. Expanding waterstops may be placed on the slurry coat after it has dried or before application. Slurry coat may only be applied over waterstop if approved by waterstop manufacturer.

Note 2: Keyways may be incorporated into the joint design at the discretion of the designer.

Note 3: Schematic drawing shows Xypex Admix application. Specifier may consider the alternative use of Xypex dry shake (DS-Series) or Xypex coatings, where applicable. Refer to Xypex Standard Specifications for more information.

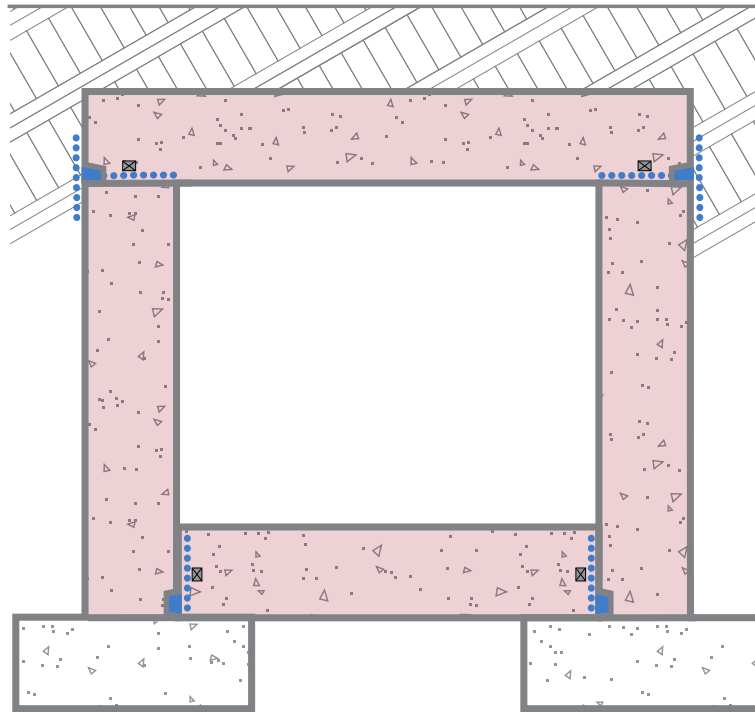
TUNNEL

●●● CONCENTRATE SLURRY COAT
 ■ CONCENTRATE DRY-PAC
 ADMIX
 X WATERSTOP

STEP 1: Where the slab will contact the wall modify the wall forms to create a linear groove in the finished concrete surface. The linear groove is to be aligned with the bottom of the slab and is to be 1½" (37 mm) high by 1" (25 mm) deep.

STEP 2: Pour Xypex Admix treated concrete and cure in accordance with ACI, EN or other applicable international standard. Strip forms including formwork for linear groove.

STEP 3: Clean linear groove thoroughly. Apply Xypex Concentrate slurry to the linear groove at the rate of 1.5 lb./sq.yd. (0.8 kg/m²). Fill linear groove with Xypex Concentrate Dry-Pac and pack tightly to create the Xypex "sealing strip".

STEP 4: Apply slurry of Xypex Concentrate at 2.0 lb./sq.yd. (1.0 kg/m²) over sealing strip and extending to the full area of contact with the slab.

STEP 5: Pour bottom slab per Step 2.

STEP 6: Clean joint thoroughly. Apply Xypex Concentrate slurry to joint surface at the rate of 2.0 lb./sq.yd. (1.0 kg/m²).

STEP 7: At the bottom exterior surface of the upper slab to wall construction joint modify the forms to create a linear groove in the finished concrete surface. The linear groove is to be 1" (25 mm) high by 1½" (37 mm) deep.

STEP 8: Pour upper slab per Step 2 and strip forms. Clean linear groove thoroughly. Apply Xypex Concentrate slurry to the linear groove at the rate of 1.5 lb./sq.yd. (0.8 kg/m²). Fill linear groove with Xypex Concentrate Dry-Pac and pack tightly to create the Xypex "sealing strip".

STEP 9: Apply slurry of Xypex Concentrate at 1.5 lb./sq.yd. (0.8 kg/m²) over sealing strip and extending to 6" (150 mm) on either side. Cure for 48 - 72 hours in accordance with normal Xypex coatings curing procedures.

Note 1: Schematic diagram shows Xypex application and waterstops. Inclusion, type and position of waterstops and expansion joints are at the discretion of the designer. Expanding waterstops may be placed on the slurry coat after it has dried or before application. Slurry coat may only be applied over waterstop if approved by waterstop manufacturer.

Note 2: Keyways may be incorporated into the joint design at the discretion of the designer.

Note 3: Xypex Admix may be considered for footings to protect the concrete and thus extend the service life of the structure.

Note 4: Schematic drawing shows Xypex Admix application. Specifier may consider the alternative use of Xypex dry shake (DS-Series) or Xypex coatings, where applicable. Refer to Xypex Standard Specifications for more information.

SWIMMING POOL

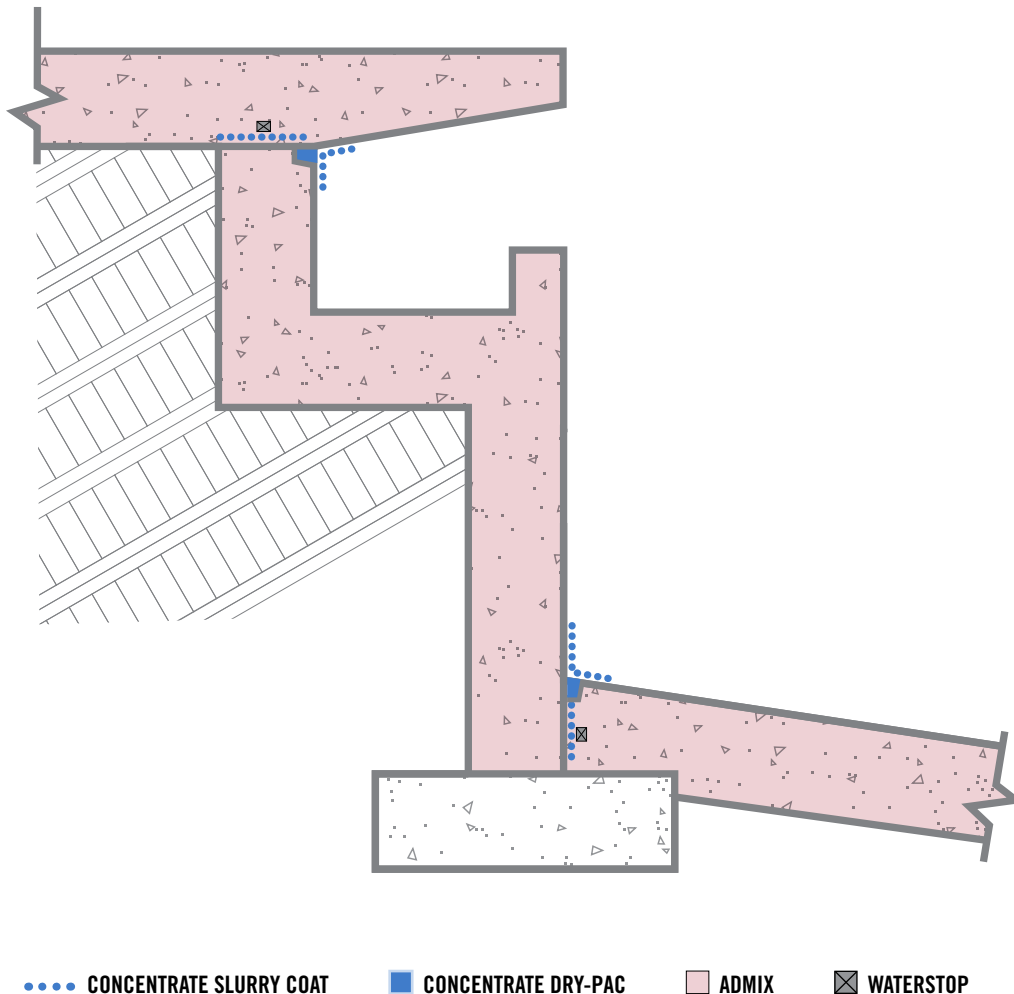

STEP 1: Clean joint thoroughly. Apply Xypex Concentrate slurry to joint surface at the rate of 2.0 lb./sq.yd. (1.0 kg/m²).

STEP 2: On the inside of the pool, where the slab will contact the wall, create a linear groove in the finished concrete surface of the slab. The linear groove is to be aligned with and included at all construction joints and is to be 1" (35 mm) wide by 1½" (37 mm) deep.

STEP 3: Pour Xypex Admix treated concrete and cure in accordance with ACI, EN or other applicable international standard. Strip forms including formwork for linear groove.

STEP 4: Clean linear groove thoroughly. Apply Xypex Concentrate slurry to the linear groove at the rate of 1.5 lb./sq.yd. (0.8 kg/m²). Fill linear groove with Xypex Concentrate Dry-Pac and pack tightly to create the Xypex "sealing strip".

STEP 5: Apply slurry of Xypex Concentrate at 1.5 lb./sq.yd. (0.8 kg/m²) over sealing strip and extending to 6"

(150 mm) on either side. Cure for 48 - 72 hours in accordance with normal Xypex coatings curing procedures.

Note 1: Schematic diagram shows Xypex application and waterstops. Inclusion, type and position of waterstops and expansion joints are at the discretion of the designer. Expanding waterstops may be placed on the slurry coat after it has dried or before application. Slurry coat may only be applied over waterstop if approved by waterstop manufacturer.

Note 2: Keyways may be incorporated into the joint design at the discretion of the designer.

Note 3: Xypex Admix may be considered for footings to protect the concrete and thus extend the service life of the structure.

Note 4: Schematic drawing shows Xypex Admix application. Specifier may consider the alternative use of Xypex dry shake (DS-Series) or Xypex coatings, where applicable. Refer to Xypex Standard Specifications for more information.

SEWAGE CLARIFIER

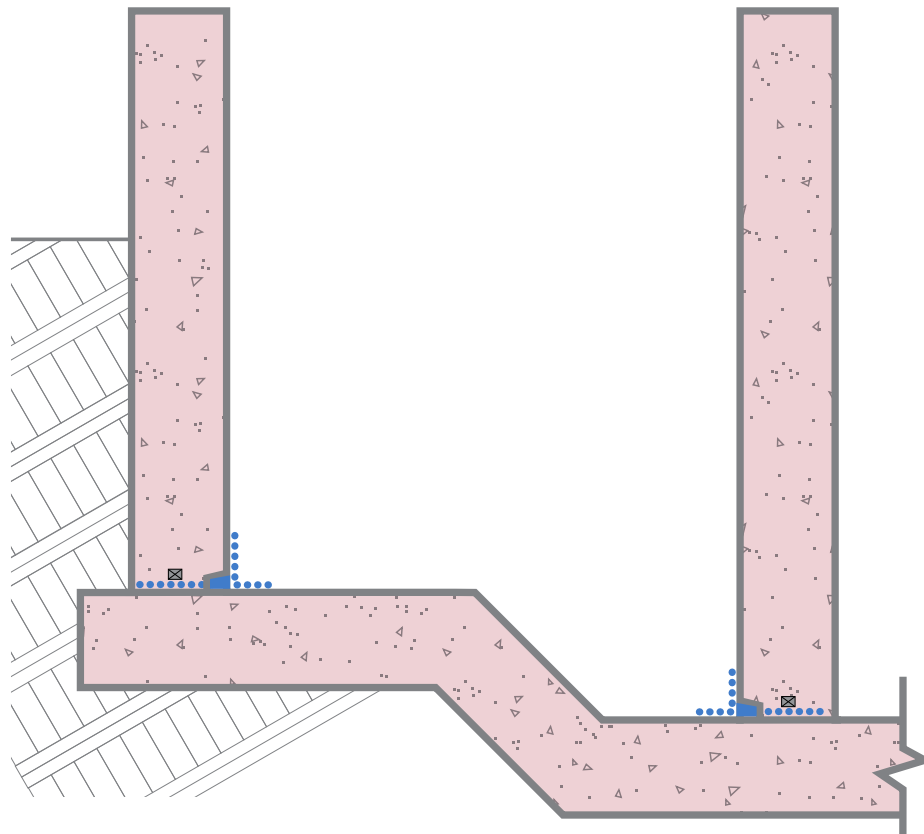

..... CONCENTRATE SLURRY COAT ■ CONCENTRATE DRY-PAC ■ ADMIX ⊠ WATERSTOP

STEP 1: Clean joint thoroughly. Apply Xypex Concentrate slurry to joint surface at the rate of 2.0 lb./sq.yd. (1.0 kg/m²).

STEP 2: On the inside of the tank, modify the forms to create a linear groove in the finished concrete surface. The linear groove is to be aligned with and included at all construction joints and to be 1" (25 mm) high by 1½" (37 mm) deep.

STEP 3: Pour Xypex Admix treated concrete and cure in accordance with ACI, EN or other applicable international standard. Strip forms including formwork for linear groove.

STEP 4: Clean linear groove thoroughly. Apply Xypex Concentrate slurry to the linear groove at the rate of 1.5 lb./sq.yd. (0.8 kg/m²). Fill linear groove with Xypex Concentrate Dry-Pac and pack tightly to create the Xypex "sealing strip".

STEP 5: Apply slurry of Xypex Concentrate at 1.5 lb./sq.yd. (0.8 kg/m²) over sealing strip and extending to 6" (150 mm) on either side. Cure for 48 - 72 hours in accordance with normal Xypex coatings curing procedures.

Note 1: Schematic diagram shows Xypex application and waterstops. Inclusion, type and position of waterstops and expansion joints are at the discretion of the designer. Expanding waterstops may be placed on the slurry coat after it has dried or before application. Slurry coat may only be applied over waterstop if approved by waterstop manufacturer.

Note 2: Keyways may be incorporated into the joint design at the discretion of the designer.

Note 3: Schematic drawing shows Xypex Admix application. Specifier may consider the alternative use of Xypex dry shake (DS-Series) or Xypex coatings, where applicable. Refer to Xypex Standard Specifications for more information.

WALL WITH KICKER

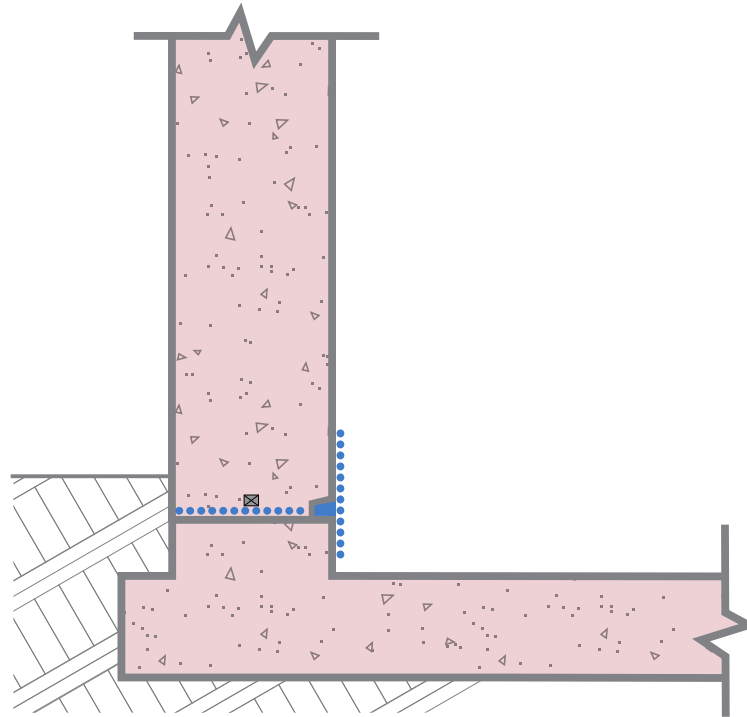

..... CONCENTRATE SLURRY COAT
 ■ CONCENTRATE DRY-PAC
 ■ ADMIX
 ⊗ WATERSTOP

STEP 1: Clean joint thoroughly. Apply Xypex Concentrate slurry to joint surface at the rate of 2.0 lb./sq.yd. (1.0 kg/m²).

STEP 2: On the inside of the tank, modify the forms to create a linear groove in the finished concrete surface. The linear groove is to be aligned with and included at all construction joints and to be 1" (25 mm) high by 1½" (37 mm) deep.

STEP 3: Pour Xypex Admix treated concrete and cure in accordance with ACI, EN or other applicable international standard. Strip forms including formwork for linear groove.

STEP 4: Clean linear groove thoroughly. Apply Xypex Concentrate slurry to the linear groove at the rate of 1.5 lb./sq.yd. (0.8 kg/m²). Fill linear groove with Xypex Concentrate Dry-Pac and pack tightly to create the Xypex "sealing strip".

STEP 5: Apply slurry of Xypex Concentrate at 1.5 lb./sq.yd. (0.8 kg/m²) over sealing strip and extending to 6" (150 mm) on either side. Cure for 48 - 72 hours in accordance with normal Xypex coatings curing procedures.

Note 1: Schematic diagram shows Xypex application and waterstops. Inclusion, type and position of waterstops and expansion joints are at the discretion of the designer. Expanding waterstops may be placed on slurry coat after it has dried or before slurry coat application. Slurry coat may only be applied over waterstop if approved by waterstop manufacturer.

Note 2: Keyways may be incorporated into the joint design at the discretion of the designer.

Note 3: Schematic drawing shows Xypex Admix application. Specifier may consider the alternative use of Xypex dry shake (DS-Series) or Xypex coatings, where applicable. Refer to Xypex Standard Specifications for more information.

RESERVOIR / WET WELL

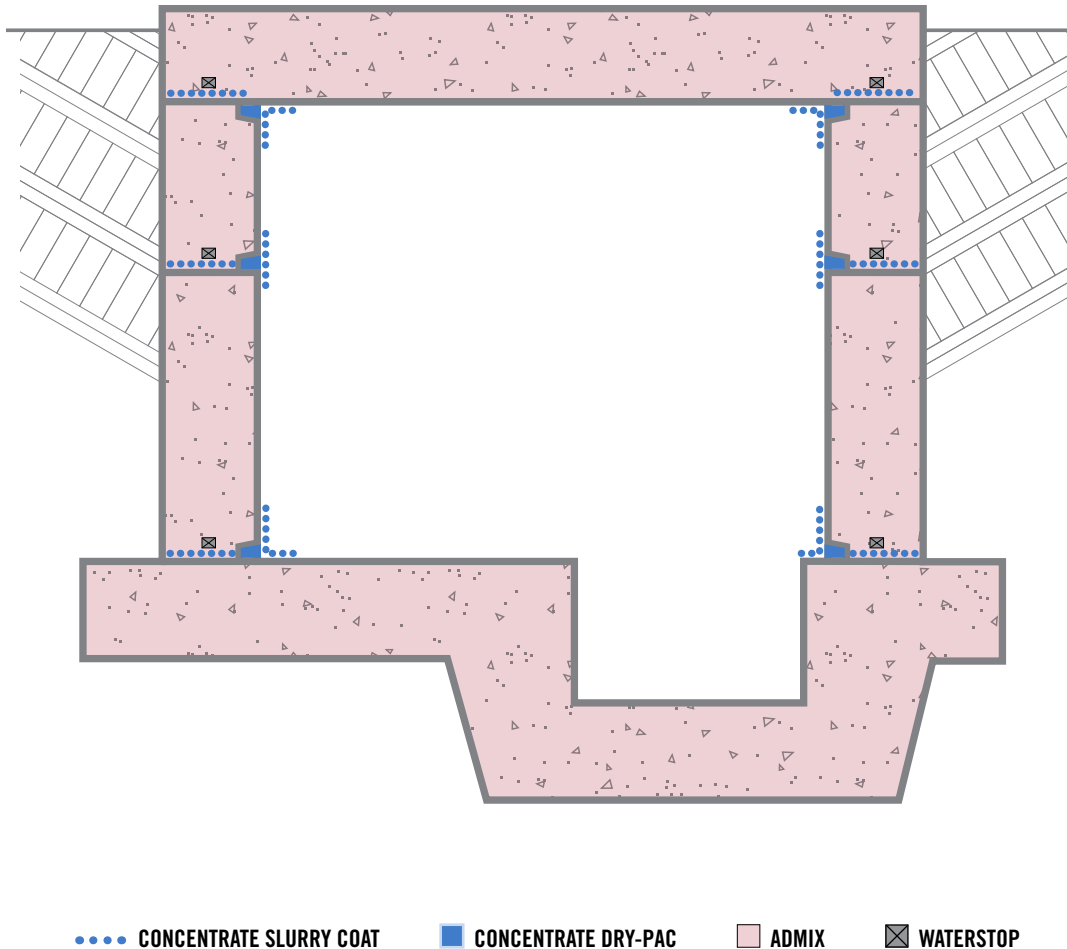

STEP 1: Clean joint thoroughly. Apply Xypex Concentrate slurry to joint surface at the rate of 2.0 lb./sq.yd. (1.0 kg/m²).

STEP 2: On the inside of the tank, modify the forms to create a linear groove in the finished concrete surface. The linear groove is to be aligned with and included at all construction joints and to be 1" (25 mm) high by 1½" (37 mm) deep.

STEP 3: Pour Xypex Admix treated concrete and cure in accordance with ACI, EN or other applicable international standard. Strip forms including formwork for linear groove.

STEP 4: Clean linear groove thoroughly. Apply Xypex Concentrate slurry to the linear groove at the rate of 1.5 lb./sq.yd. (0.8 kg/m²). Fill linear groove with Xypex Concentrate Dry-Pac and pack tightly to create the Xypex "sealing strip".

STEP 5: Apply slurry of Xypex Concentrate at 1.5 lb./sq.yd. (0.8 kg/m²) over sealing strip and extending to 6" (150 mm) on either side. Cure for 48 - 72 hours in accordance with normal Xypex Coatings curing procedures.

Note 1: Schematic diagram shows Xypex application and waterstops. Inclusion, type and position of waterstops and expansion joints are at the discretion of the designer. Expanding waterstops may be placed on the slurry coat after it has dried or before application. Slurry coat may only be applied over waterstop if approved by waterstop manufacturer.

Note 2: Keyways may be incorporated into the joint design at the discretion of the designer.

Note 3: Schematic drawing shows Xypex Admix application. Specifier may consider the alternative use of Xypex dry shake (DS-Series) or Xypex coatings, where applicable. Refer to Xypex Standard Specifications for more information.

UNDERGROUND VAULT / DRY WELL

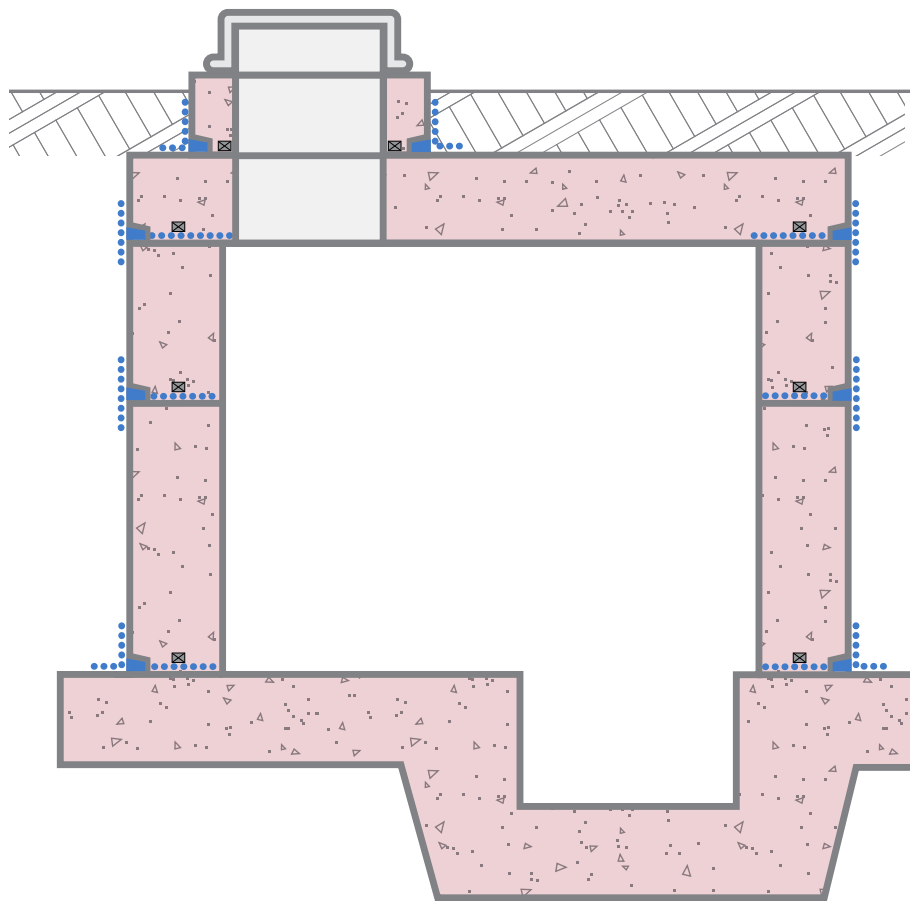

..... CONCENTRATE SLURRY COAT
 ■ CONCENTRATE DRY-PAC
 ■ ADMIX
 X WATERSTOP

STEP 1: Clean joint thoroughly. Apply Xypex Concentrate slurry to joint surface at the rate of 2.0 lb./sq.yd. (1.0 kg/m²).

STEP 2: On the outside of vault/dry well, modify the forms to create a linear groove in the finished concrete surface. The linear groove is to be aligned with and included at all construction joints and to be 1" (25 mm) high by 1½" (37 mm) deep.

STEP 3: Pour Xypex Admix treated concrete and cure in accordance with ACI, EN or other applicable international standard. Strip forms including formwork for linear groove.

STEP 4: Clean linear groove thoroughly. Apply Xypex Concentrate slurry to the linear groove at the rate of 1.5 lb./sq.yd. (0.8 kg/m²). Fill linear groove with Xypex Concentrate Dry-Pac and pack tightly to create the Xypex "sealing strip".

STEP 5: Apply slurry of Xypex Concentrate at 1.5 lb./sq.yd. (0.8 kg/m²) over sealing strip and extending to 6" (150 mm) on either side. Cure for 48 - 72 hours in accordance with normal Xypex coatings curing procedures.

Note 1: Schematic diagram shows Xypex application and waterstops. Inclusion, type and position of waterstops and expansion joints are at the discretion of the designer. Expanding waterstops may be placed on the slurry coat after it has dried or before application. Slurry coat may only be applied over waterstop if approved by waterstop manufacturer.

Note 2: Keyways may be incorporated into the joint design at the discretion of the designer.

Note 3: Schematic drawing shows Xypex Admix application. Specifier may consider the alternative use of Xypex dry shake (DS-Series) or Xypex coatings, where applicable. Refer to Xypex Standard Specifications for more information.

PRECAST CONCRETE MANHOLE

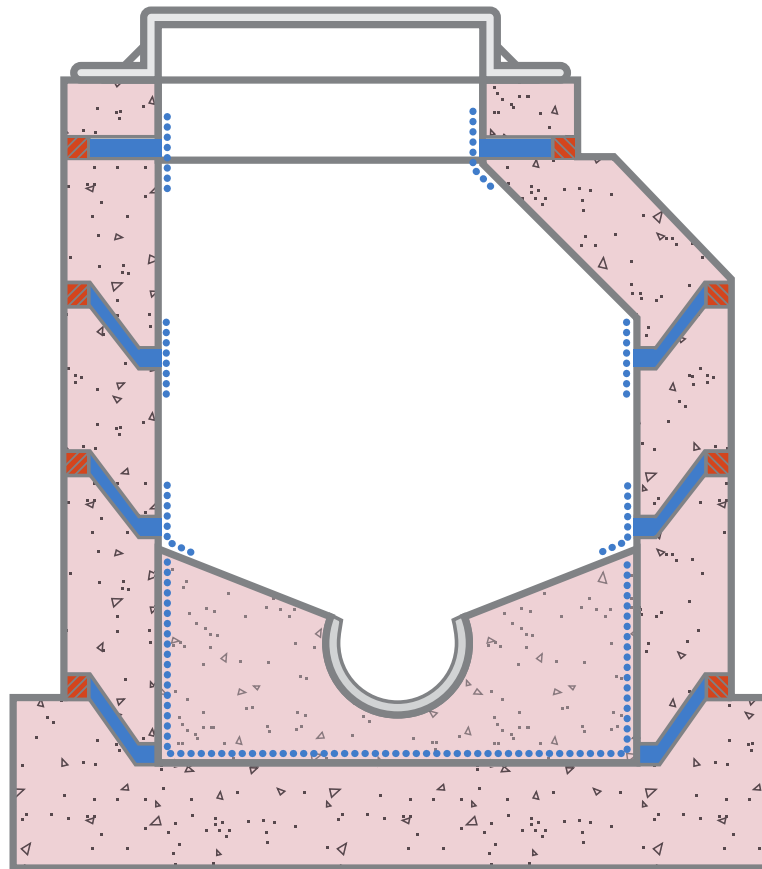

..... CONCENTRATE SLURRY COAT
 CONCENTRATE DRY-PAC
 ADMIX
 PATCH'N PLUG

Steps 1 and 2 are used when waterproof gasketting or other assemblies are not included.

STEP 1: Place blocks in joints to allow 0.5" - 0.75" (13 - 19 mm) gap between precast sections. Fill exterior gap with Xypex Patch'n Plug or Xypex Megamix II to a depth of 2" - 3" (50 - 75 mm).

STEP 2: In the interior of the manhole, apply slurry of Xypex Concentrate to the interior gap at the rate of 1.5 lb./sq.yd. (0.8 kg/m²) then fill gap to the surface with Xypex Concentrate in Dry-Pac. Apply slurry of Xypex Concentrate at 1.5 lb./sq.yd. (0.8 kg/m²) over Dry-Pac and extending to 6" (150 mm) on either side.

STEP 3: Apply slurry coat of Xypex Concentrate to interior of bottom ring and floor where the invert interfaces at a rate of 1.5 lb./sq.yd. (0.8 kg/m²).

STEP 4: Place concrete invert using Xypex Admix treated concrete and cure in accordance with ACI, EN or other applicable international standard.

Note: Schematic drawing shows Xypex Admix application. Specifier may consider the alternative use of Xypex dry shake (DS-Series) or Xypex coatings, where applicable. Refer to Xypex Standard Specifications for more information.

BRIDGE

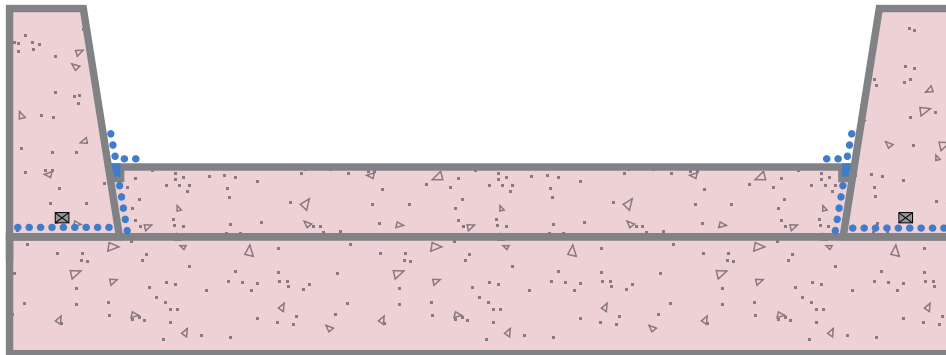

..... CONCENTRATE SLURRY COAT ■ CONCENTRATE DRY-PAC ■ ADMIX ⊗ WATERSTOP

STEP 1: Clean joint thoroughly. Apply Xypex Concentrate slurry to joint surface at the rate of 2.0 lb./sq.yd. (1.0 kg/m²).

STEP 2: Where the bridge deck topping slab will contact the bridge parapet, create a linear groove in the finished concrete surface of the slab. The linear groove is to be aligned with and included at all slab to parapet construction joints and to be 1" (25 mm) wide by 1½" (37 mm) deep.

STEP 3: Pour Xypex Admix treated concrete and cure in accordance with ACI, EN or other applicable international standard. Strip forms including formwork for linear groove.

STEP 4: Clean linear groove thoroughly. Apply Xypex Concentrate slurry to the linear groove at the rate of 1.5 lb./sq.yd. (0.8 kg/m²). Fill linear groove with Xypex Concentrate Dry-Pac and pack tightly to create the Xypex "sealing strip".

STEP 5: Apply slurry of Xypex Concentrate at 1.5 lb./sq.yd. (0.8 kg/m²) over sealing strip and extending to 6" (150 mm) on either side. Cure for 48 - 72 hours in accordance with normal Xypex coatings curing procedures.

Note 1: Bridge decks are normally subject to variable live loads that may create movement in cracks beyond the ability of Xypex to heal. Consult your local Xypex Technical Services Representative.

Note 2: Schematic diagram shows Xypex application and waterstops. Inclusion, type and position of waterstops and expansion joints are at the discretion of the designer. Expanding waterstops may be placed on the slurry coat after it has dried or before application. Slurry coat may only be applied over waterstop if approved by waterstop manufacturer.

Note 3: Keyways may be incorporated into the joint design at the discretion of the designer.

Note 4: Schematic drawing shows Xypex Admix application. Specifier may consider the alternative use of Xypex dry shake (DS-Series) or Xypex coatings, where applicable. Refer to Xypex Standard Specifications for more information.



Allentown Testing Laboratories, Inc.
 USA

“Certificate of Test and Analysis”, Allentown Testing Laboratories, Inc, Pennsylvania, USA



Amtliche Materialprüfanstalt
 Germany

“Testing of Xypex Concentrate with Regard to Water Impermeability (Negative Test)”, DIN 1048, Amtliche Materialprüfanstalt, Clausthal-Zellerfeld, Germany



Armabeton a.s.
 Czech Republic

“Evaluation of Increase in Strength for Concrete B20 with an Additive of Xypex Admix C-2000”, ÈSN 73 1317, Armabeton a.s., Praha, Czech Republic



TEST REPORTS



Australian Centre for Construction Innovation
Australia

“Microscopic Examination of Crystalline Products in Three Xypex Admix Modified Concretes”, Scanning Electron Microscopy (SEM), Australian Centre for Construction Innovation (ACCI), University of New South Wales, Sydney, NSW, Australia



Aviles Engineering Corporation
USA

“Effects of Sulfuric Acid on Concrete Samples”, Aviles Engineering Corporation, Houston, Texas, USA



Aviles Engineering Corporation
USA

“Permeability Test on Treated and Untreated Concrete Samples”, Army Corps of Engineers CRD C48, Aviles Engineering Corporation, Houston, Texas, USA



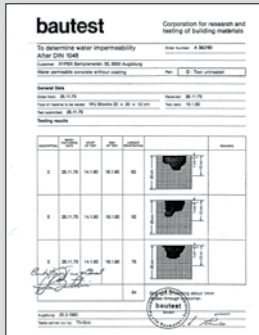

Bautest Corporation
Germany

“To Determine Water Impermeability”, DIN 1048,
Bautest Corporation, Augsburg, Germany

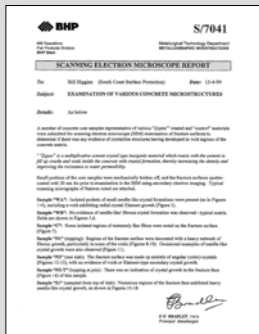

BHP Steel
Australia

“Examination of Various Concrete Microstructures”,
Scanning Electron Microscopy (SEM), Metallurgical Technology
Department, BHP, NSW, Australia

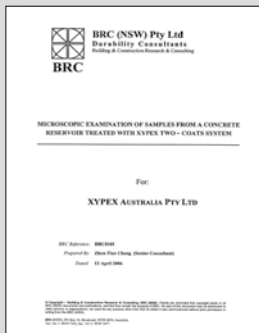

Building & Construction Research & Consulting
Australia

“Microscopic Examination of Samples from a Concrete Reservoir Treated with Xypex Two-Coat System”,
Scanning Electron Microscopy (SEM), BRC (NSW) Pty Ltd,
Building & Construction Research & Consulting, Brookvale,
NSW, Australia



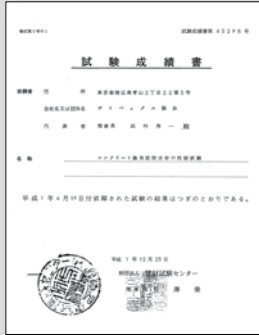

Building Materials Test Center
Japan

“Performance Test (Freeze-Thaw) of the Concrete Coated with Waterproofing Agent”, JIS A 6204, Building Materials Test Center, Tokyo, Japan

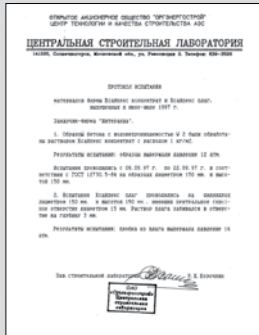

Central Construction Laboratory
Russia

“To Evaluate the Water Tightness of Samples of Concrete with Xypex Coating”, GOST 12730.5, Central Construction Laboratory, Public Corporation “Orgenergostroi”, Moscow, Russia



Central Construction Laboratory
Russia

“Test of the Materials Xypex Concentrate and Xypex Patch’n Plug”, GOST 12730.5-84, Central Construction Laboratory, Public Corporation “Orgenergostroi”, Moscow, Russia

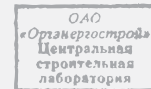

TEST REPORTS

Clifton Associates Ltd.
Canada

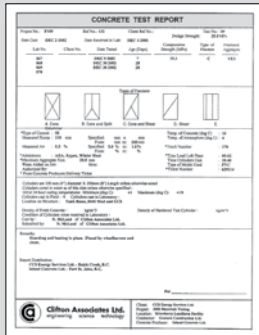

“Compressive Strength of Cylindrical Concrete Specimens”,
Clifton Associates Ltd., Fort St. John, BC, Canada



Construction Bureau of Chubu District
Japan

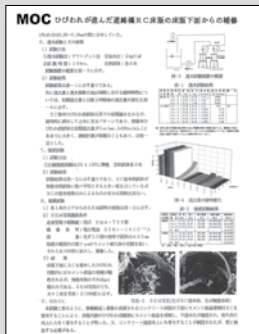

“Repairing of Heavily Cracked Reinforced Concrete Bridge Deck Slab from Underside”, Construction Bureau of Chubu District, The Ministry of Construction, Aichi Institute of Technology, Japan

MOC

C.R.S. Ltd.
Japan



“Acid-Proofed Concrete Test Report”, Japan Industrial Standards (JIS) C.R.S. Ltd. (Central Research Laboratory), Tokyo, Japan

CRS

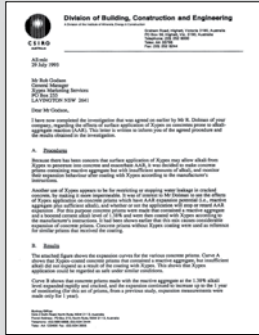

CSIRO Division of Building
Australia

“Effects of Surface Application of Xypex on Concretes Prone to Alkali-Aggregate Reaction (AAR)”, CSIRO Division of Building, Construction and Engineering, Highett, VIC, Australia

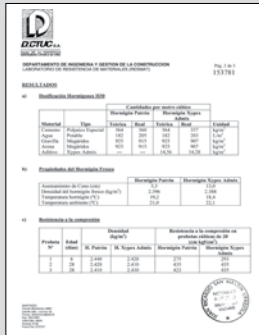

DICTUC S.A.
Chile

“Impermeability to Water”, DIN 1048, DICTUC S.A., Department of Engineering and Construction Management, Santiago, Chile



Gradis Teo
Slovenia

“Investigation of Xypex-Treated Concrete Resistance to Freezing and Thawing with Salt”, JUS Standard U.M1.055, Gradis Teo, Technical, Economic and Organizational Services, d.d., Ljubljana, Slovenia



TEST REPORTS

Hardy BBT Limited
Canada

“Evaluate Direct Tensile Bond Strength and Abrasion Resistance of Plain Concrete and Concrete Treated with Xypex DS-2”, CAN/CSA A23.2-6B, Hardy BBT Limited, Burnaby, BC, Canada

Hardy BBT Limited

AGRA
Canada

“Compressive Strength Test – Xypex Admix Samples”, HBT Agra Ltd, Vancouver, BC, Canada

AGRA

Hönnun Ltd.
Iceland

“Activity of Xypex Concentrate & Admix in Icelandic Concrete”, U.S. Army Corps of Engineers CRD C48-73, NT Build 492 and 443, Hönnun Ltd, Consulting Engineers, Reykjavik, Iceland

HÖNNUN

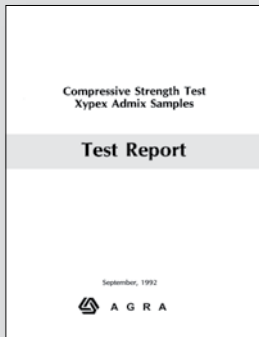

TEST REPORTS

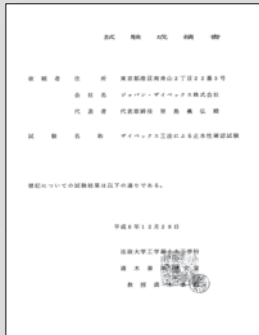

Hosei University
Japan

“Sealing Effectiveness of Xypex Concentrate Coating”,
Hosei University, Department of Technology, Tokyo, Japan

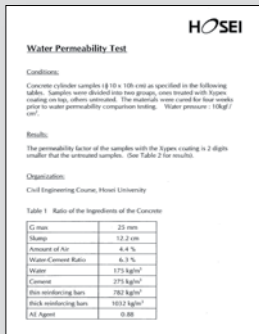

Hosei University
Japan

“Water Permeability Test”, Civil Engineering Department,
Hosei University, Tokyo, Japan

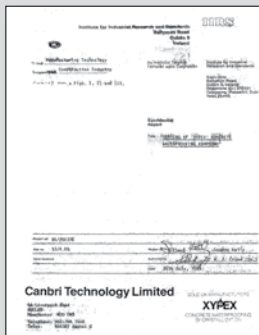

Institute for Industrial Research and Standards
Ireland

“Testing of Xypex Concrete Waterproofing Compound”,
Institute for Industrial Research and Standards, Dublin, Ireland



TEST REPORTS

ITH – Instituto Tecnológico Del Hormigon S.A.
Argentina

“Testing of a Mix of Concrete with the Inclusion of Powder Additive Xypex Admix C-2000”, ITH – Instituto Tecnológico Del Hormigon S.A., Buenos Aires, Argentina

Instituto Tecnológico Del Hormigon S.A.

Iwate University
Japan

“Chemical Durability of Cement Crystal Increasing Agent Applied Concrete”, Department of Civil & Environmental Engineering, Iwate University, Morioka, Japan

Japan Atomic Energy Research Institute
Japan

“Studies on Diffusion of 137Cs in Cement Mortar”, Japan Atomic Energy Research Institute (JAERI), Tokai-mura, Japan

日本原子力研究所
Japan Atomic Energy Research Institute

TEST REPORTS

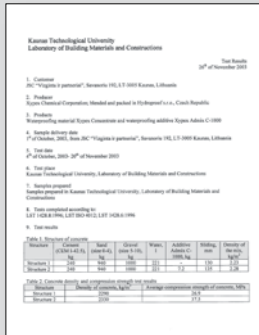

Kaunas Technological University
Lithuania

“Water Permeability of Xypex-Treated Concrete”,
LST 1330, Laboratory of Building Materials and Constructions,
Kaunas Technological University, Kaunas, Lithuania



Kleinfelder
USA

“Compressive Strength Testing of Concrete Containing
Xypex Admix”, Kleinfelder, Inc, San Francisco, California, USA



Klokner Institute
Czech Republic

“Tests of Impermeability and Resistance of Xypex Coating
to: Silage Juices, Diesel Oil, Gasoline and Transformer Oil”,
Klokner Institute, Czech University of Technology, Prague,
Czech Republic



TEST REPORTS



Klokner Institute
Czech Republic

“Evaluation of Porosity of Concrete Treated with Xypex Coating Materials”, Klokner Institute, Czech University of Technology, Prague, Czech Republic

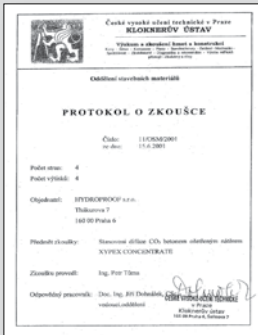

Klokner Institute
Czech Republic

“Determination of CO₂ Diffusion Through Concrete Treated with a Coating of Xypex Concentrate”, Klokner Institute, Czech Technical University, Prague, Czech Republic



Levelton Engineering Ltd.
Canada

“Laboratory Physical Testing – Xypex Megamix II Repair Mortar”, ASTM C109, C78, C496, C1202, C642, Levelton Engineering Ltd., Richmond, BC, Canada





LPM (Laboratories for Preparation & Methodology)
Switzerland

“To Determine Permeability and Imperviousness”,
LPM (Laboratories for Preparation and Methodology),
Beinwil am See, Switzerland

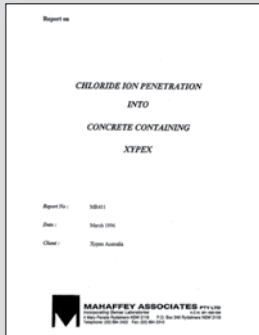

Mahaffey Associates Pty Ltd.
Australia

“Chloride Ion Penetration into Concrete Containing Xypex”,
Mahaffey Associates Pty Ltd., Rydalmere, NSW, Australia



Metro Testing Laboratories Ltd.
Canada

“Bond Pull-Off Testing – Xypex Megamix I and Megamix II”,
Metro Testing Laboratories Ltd., Burnaby, BC, Canada



TEST REPORTS

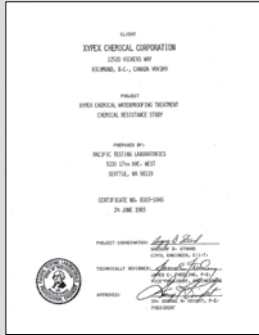

Pacific Testing Laboratories
USA

“Xypex Chemical Waterproofing Treatment Chemical Resistance Study”, ASTM C-267, Pacific Testing Laboratories, Seattle, Washington, USA

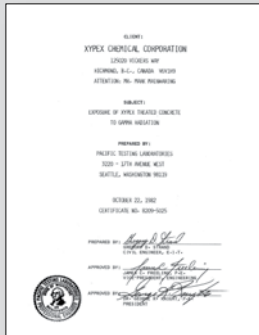

Pacific Testing Laboratories
USA

“Exposure of Xypex Treated Concrete to Gamma Radiation”, USA Standard No. N6.9, Pacific Testing Laboratories, Seattle, Washington, USA

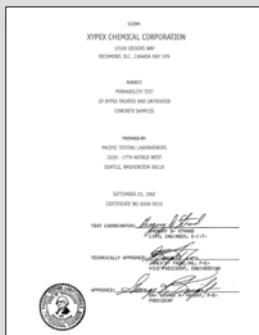

Pacific Testing Laboratories
USA

“Permeability Test of Treated and Untreated Concrete Samples”, U.S. Army Corps of Engineers CRD C48, Pacific Testing Laboratories, Seattle, Washington, USA



TEST REPORTS

Professional Services Industries
USA

“Xypex Admix C-2000 Compressive Strength Evaluation”,
ASTM 39, Professional Services Industries, Inc. (PSI),
Corpus Christi, Texas, USA

Setsco Services Pte Ltd.
Singapore

“Petrographic Examination of Hardened Concrete Core”,
ASTM C856, Setsco Services Pte Ltd., Singapore

Setsco Services Pte Ltd.
Singapore

“Effectiveness of Xypex Products on Waterproofing
Capability, Heat Reduction in Concrete, and Compressive
Strength”, CRD C48 (modified), SS 78, BS 1881,
Setsco Services Pte Ltd., Singapore

TEST REPORTS**Slovak University of Technology**

Slovak Republic

“Testing of the Effectiveness of the Coating Material Xypex to Prevent Gas Permeability of the Concrete”, Slovak University of Technology, Department of Concrete Construction and Bridges, Bratislava, Slovak Republic

**Taywood Engineering Limited**

Australia

“Resistance of Concrete to Harsh Environments – Ammonium Sulphate”, Taywood Engineering Limited, Perth, WA, Australia

**Technologisches Gewerbemuseum**

Austria

“Testing of Sealing Effect re Penetration of Water”, ÖNORM B 3303, Technologisches Gewerbemuseum (Industrial Museum of Technology), Federal Higher Technical Education and Research Institute, Vienna, Austria



TEST REPORTS

Technical Testing Institute of Civil Engineering
Slovak Republic

“Test for Strength of Xypex Admix-Treated Concrete Samples Under Compression”, STN 73 1317, Technical Testing Institute of Civil Engineering, Bratislava, Slovak Republic

Technical Testing Institute of Civil Engineering
Slovak Republic

“Test of Xypex Admix-Treated Concrete Samples for Water Tightness”, STN 73 1321, Technical Testing Institute of Civil Engineering, Bratislava, Slovak Republic

Technical Testing Institute of Civil Engineering
Slovak Republic

“Testing of Impermeability and Resistance of the Xypex Coating Material to Crude Oil”, Institute of Civil Engineering Technology & Testing, Bratislava, Slovak Republic

TEST REPORTS



Technical Testing Institute of Civil Engineering
Slovak Republic

“Tests of Impermeability and Resistance of the Xypex Coating Material to Gasoline, Diesel, Transformer Oil, Silage Juices and Pressurized Water”, CSN 73 1209 and CSN 73 1321, Institute of Civil Engineering Technology & Testing, Bratislava, Slovak Republic





Technical Testing Institute of Civil Engineering
Slovak Republic

“Tests of Fluid Tightness and Resistance of the Coating Material Xypex Concentrate Against Acetone”, STN 73 1311, Institute of Technology & Testing in Civil Engineering, Bratislava, Slovak Republic





Technical Testing Institute of Civil Engineering
Slovak Republic

“Tests of Fluid Tightness and Resistance of the Coating Material Xypex Concentrate Against Sulfuric Acid and Sulfide”, Institute of Technology & Testing in Civil Engineering, Bratislava, Slovak Republic





Technical Testing Institute of Civil Engineering
Slovak Republic

“Tests of Fluid Tightness and Resistance of the Coating Material Xypex Concentrate Against Turpentine”, STN 73 1311, Institute of Technology & Testing in Civil Engineering, Bratislava, Slovak Republic



Twin City Testing and Engineering Laboratory
USA

“Evaluation of Treated and Untreated Concrete Panels Exposed to De-Icing Chemicals”, ASTM C672, Twin City Testing and Engineering Laboratory, Inc, St. Paul, Minnesota, USA



Twin City Testing and Engineering Laboratory
USA

“Test to Evaluate Water Penetration Through Concrete Masonry Units”, Twin City Testing and Engineering Laboratory, Inc, St. Paul, Minnesota, USA



TEST REPORTS

Universidad de Los Andes
Colombia

“Test of Permeability of Concrete”, Corps of Engineers CRD C48, Universidad de Los Andes, Departamento de Ingenieria Civil y Ambiental, Laboratorio de Estructuras Geotecnia y Pavimentos, Bogota, Colombia

University of New South Wales
Australia

“Investigation of Concrete Slabs Modified with Xypex Waterproofing Admixture”, Building Research Centre, University of New South Wales, Sydney, NSW, Australia

University of New South Wales
Australia

“Chloride Penetration Tests on Xypex Admix C-1000 NF Modified Commercial Concretes”, ASTM C1202 (modified) and NT Build 443, University of New South Wales, Sydney, NSW, Australia

TEST REPORTS



University of New South Wales
Australia

“Plastic and Hardened State Properties of Xypex Admix C-1000 NF Modified Commercial Concreted”,
Slump (AS1012.3), Setting Time (AS1012.18), Compressive Strength (AS1012.9), Dry Shrinkage (AS1012.13),
University of New South Wales, Sydney, NSW, Australia

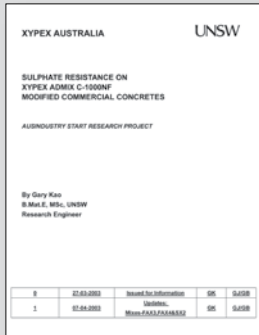

University of New South Wales
Australia

“Sulphate Resistance on Xypex Admix C-1000 NF Modified Commercial Concreted”, AS2350.14, University of New South Wales, Sydney, NSW, Australia



University of New South Wales
Australia

“Water Absorption & AVPV and Water Permeability on Xypex Admix Modified Commercial Concreted”,
AS1012.21 and ACCI, University of New South Wales,
Sydney, NSW, Australia



TEST REPORTS

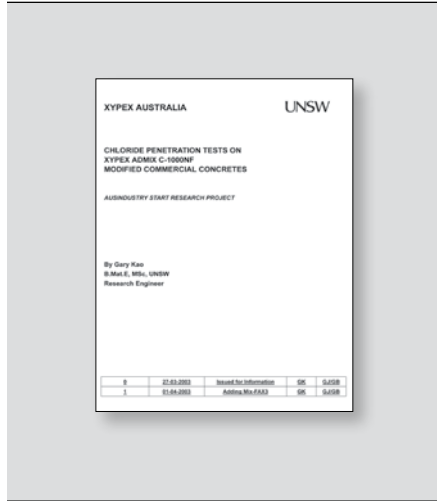

University of New South Wales
Australia

“Chloride Penetration Test Report on Fly Ash Blended Cement Using Xypex Admix C-1000 NF”, CSIRO modified ASTM C1202, ACCI, NT Build 443, University of New South Wales, NSW, Australia

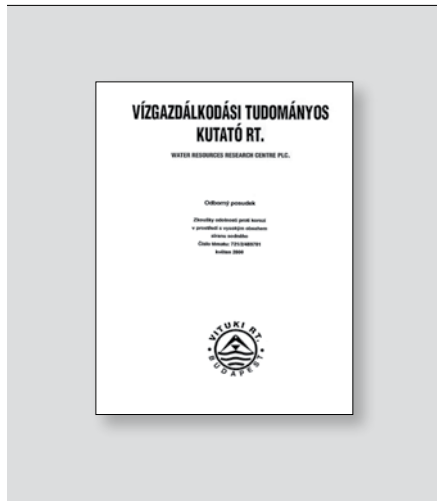
Water Resources Management Scientific Research Company
Hungary

“Corrosion Resistance Studies in High Concentration Sodium Sulphate Medium”, Water Resources Management Scientific Research Company (Vituki), Budapest, Hungary

Warnock Hersey Professional Services Ltd.
Canada

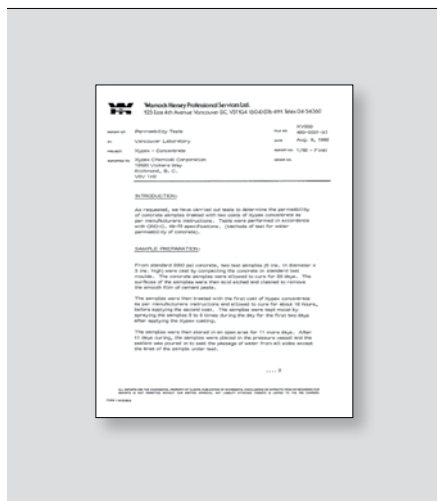
“Tests to Determine the Permeability of Concrete Samples Treated with Two Coats of Xypex Concentrate”, Corps of Engineers CRD C48, Warnock Hersey Professional Services Ltd, Vancouver, BC, Canada









APPROVALS









Section	Page
Departments of Transportation	1
General	2
Food & Potable Water	4
Health Safety	7
Environmental	7
Quality Systems	8

APPROVALS

DEPARTMENTS OF TRANSPORTATION









	<p><i>Departments of Transportation Approval</i> Commonwealth of Kentucky, Transportation Cabinet Frankfort, KY, USA</p>
	<p><i>Departments of Transportation Approval</i> Commonwealth of Pennsylvania, Department of Transportation Harrisburg, PA, USA</p>
	<p><i>Departments of Transportation Approval</i> Colorado Department of Highways Denver, CO, USA</p>
	<p><i>Departments of Transportation Approval</i> Oregon Department of Transportation, Highway Division, Materials & Research Section Salem, OR, USA</p>
	<p><i>Departments of Transportation Approval</i> New York Metropolitan Transportation Authority New York City, NY, USA</p>
	<p><i>Departments of Transportation Approval</i> State of Tennessee, Department of Transportation Nashville, TN, USA</p>
	<p><i>Departments of Transportation Approval</i> Roads and Maritime Services Australian New South Wales, Australia</p>

APPROVALS

GENERAL	
	<p><i>Product Approval</i> Louisville and Jefferson County Metropolitan Sewer District Louisville, KY, USA</p>
	<p><i>Product Approval</i> BBA British Board of Agrément, Technical Approvals for Construction Herts, United Kingdom</p>
	<p><i>Product Approval</i> BSI Product Services, Construction Products Directive, Council of European Communities Hertfordshire, United Kingdom</p>
	<p><i>Product Approval</i> CEBTP Centre d'Expertise Du Batiment et des Travaux Publics Saint-Rémy-Lès-Chevreuse, France</p>
	<p><i>Product Approval</i> City of Los Angeles, Department of Building and Safety Los Angeles, CA, USA</p>
	<p><i>Product Approval</i> Deutsches Institut Für Bautechnik, Anstalt des Öffentlichen Rechts (DIBT) Berlin, Germany</p>
	<p><i>Product Approval</i> ICC Evaluation Service Inc. Whittier, CA, USA</p>
	<p><i>Product Approval</i> Instytut Techniki Budowlanej (ITB) Warszawa, Poland</p>

APPROVALS

GENERAL (cont.)

	<p><i>Product Approval</i> NETIS, New Technology Utilization System for Public Works Niigata City, Japan</p>
	<p><i>Product Approval</i> Országos Vízügyi Főigazgatóság (OVF), State Water Conservancy Directorate Budapest, Hungary</p>
<p>VATTENFALL </p>	<p><i>Product Approval</i> Vattenfall Utveckling Certifierings, The State Power Board Stockholm, Sweden</p>
	<p><i>Product Approval</i> VUPS Výzkumný Ústav Pozemních Staveb Praha, Czech Republic</p>
	<p><i>Product Approval</i> Instytut Badawczy Dróg i Mostów (IBDIM), Research Institute for Roads and Bridges Warsaw, Poland</p>
	<p><i>Product Approval</i> SINTEF Civil and Environmental Engineering Cement and Concrete Trondheim, Norway</p>
	<p><i>Product Approval</i> Technický a Skúšobný Ústav Stavebný (TSUS), Building Testing and Research Institute Bratislava, Slovak Republic</p>
	<p><i>Product Approval</i> City of Atlanta, Department of Watershed Management Atlanta, GA, USA</p>







APPROVALS

FOOD & POTABLE WATER

 <p>Agriculture and Agri-Food Canada</p>	<p><i>Food Approval</i> Agriculture Canada, Food Production and Inspection Branch Ottawa, ON, Canada</p>
	<p><i>Potable Water Approval</i> Eidgenössisches Gesundheitsamt, Service Fédéral de l'Hygiène Publique Berne, Switzerland</p>
 <p>Australian Water Quality Centre</p>	<p><i>Potable Water Approval</i> Australian Water Quality Centre Bolivar, South Australia</p>
 <p>NIEA www.doeni.gov.uk/niea</p>	<p><i>Potable Water Approval</i> Northern Ireland Environment Agency Belfast, Ireland</p>
	<p><i>Potable Water Approval</i> РЕПУБЛИКА БЪЛГАРИЯ, Republic of Bulgaria, Ministry of Health Sofia, Bulgaria</p>
 <p>Ontario</p>	<p><i>Potable Water Approval</i> Ontario Ministry of the Environment Toronto, ON, Canada</p>
 <p>SZÚ</p>	<p><i>Potable Water Approval</i> Státní Zdravotní Ústav, State Health Institute Prague, Czech Republic</p>
 <p>NR</p>	<p><i>Potable Water Approval</i> National Research Center, Water Pollution Control Laboratories Cairo, Egypt</p>

APPROVALS

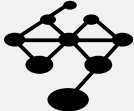
FOOD & POTABLE WATER (cont.)

	<p><i>Potable Water Approval</i> Mairie de Paris, Department of Water and Cleanliness Paris, France</p>
	<p><i>Potable Water Approval</i> Technologiezentrum Wasser (TZM), Technology Center Water Karlsruhe, Germany</p>
	<p><i>Potable Water Approval</i> Országos Tisztifőorvosi Hivatal, National Health Officer's Bureau Budapest, Hungary</p>
	<p><i>Potable Water Approval</i> Ministry of Health, Public Health Service Jerusalem, Israel</p>
	<p><i>Potable Water Approval</i> Japan Food Research Laboratories Tokyo, Japan</p>
	<p><i>Potable Water Approval</i> Singapore Institute of Standards and Industrial Research Singapore</p>
<p>DRINKING WATER INSPECTORATE</p>	<p><i>Potable Water Approval</i> DWI Drinking Water Inspectorate London, United Kingdom</p>
	<p><i>Potable Water Approval</i> Water Regulations Advisory Scheme Gwent, United Kingdom</p>

APPROVALS

FOOD & POTABLE WATER (cont.)



Potable Water Approval
**NSF Certified Products,
 Public Water Supply System Components**
 Ann Arbor, MI, USA



Potable Water Approval
Virginia Department of Health
 Richmond, VA, USA



Potable Water Approval
California Department of Health
 Fresno, CA, USA



Potable Water Approval
Florida Department of Health
 Tallahassee, FL, USA



Potable Water Approval
New York Department of Health
 Albany, NY, USA



Potable Water Approval
Helsedirektoratet, Health Services of Norway
 Oslo, Norway



Potable Water Approval
State of Ohio Environmental Protection Agency
 Columbus, OH, USA



Potable Water Approval
Texas Department of Health
 Austin, TX, USA

APPROVALS

FOOD & POTABLE WATER (cont.)



Potable Water Approval
United States Environmental Protection Agency
 Cincinnati, OH, USA

HEALTH & SAFETY



Health Safety Approval
Hrvatski Zavod Za Toksikologiju,
Croatian Toxicology Institute
 Zagreb, Croatia



Government of **Western Australia**
 Department of Health

Health Safety Approval
Health Department of Western Australia,
Environmental Health Branch
 Perth, Australia



MINISTERSTVO ZDRAVOTNICTVÍ
 ČESKÉ REPUBLIKY

Health Safety Approval
Hlavní Hygienik České Republiky,
Ministry of Health of the Czech Republic
 Prague, Czech Republic



MINISTERSTVO
 ZDRAVOTNÍCTVA

Health Safety Approval
Ministerstvo Zdravotníctva, Ministry of Health
of the Slovak Republic
 Bratislava, Slovak Republic



Tervisekaitseinspektsioon
 Health Protection Inspectorate

Health Safety Approval
Tervisekaitseinspektsioon,
Health Protection Inspectorate
 Tallinn, Estonia

ENVIRONMENTAL



GLOBAL
 GREEN TAG

Environmental Approval
Global Green Tag Pty Ltd
 Cannon Hill QLD, Australia



Environmental Approval
Ministry of Environmental Protection, Technical Requirement
for Environmental Labeling Products HJ456-2009
 Beijing, China

APPROVALS

ENVIRONMENTAL (cont.)



Environmental Approval
Croatia Green Building Council
 Zagreb, Croatia



Environmental Approval
Malaysia Green Building Confederation
 Kuala Lumpur, Malaysia



Environmental Approval
Singapore Green Building Council
 Singapore

QUALITY SYSTEMS



Quality Systems Approval
QMS International Ltd, BS EN ISO 9001:2008
 Norfolk, United Kingdom



Quality Systems Approval
BSI Group Canada, ISO 9001:2015
 Mississauga, ON, Canada



Quality Systems Approval
BSI Assurance UK Ltd, Certificate of Conformity of the Factory Production Control
 Milton Keynes, United Kingdom

WASTEWATER TREATMENT PLANTS

Xypex products are well suited for concrete structures used for the collection, pumping and treatment of wastewater. Concrete pipe, lift stations and tanks must be protected from the water and aggressive chemicals common to sewage. The crystalline waterproofing technology of Xypex works within the concrete to make it impermeable and resistant to chemical attack. Wastewater is thereby contained and the neighboring environment and the structure itself is protected.



WASTEWATER TREATMENT PLANTS



 **South District Wastewater Treatment Plant**
Miami Dade, Florida, USA

As Miami-Dade County’s population continues to increase, using reclaimed water enables the MDWASD to provide a sustainable water resource for its environment and its future.

The population growth, construction boom and a shortage of water resources are the driving forces behind this big expansion project. The plan involves reclaiming tens of millions of gallons of wastewater and a treatment process that will allow the reuse of effluent at a rate of up to 112.5 million gallons per day, making it one of the largest plants in the U.S.

In phase one, over 52,000 sq. ft. of surface area was treated with the Xypex two-coat system of Concentrate and Modified to specifically waterproof and protect the flocculation and filter tanks and flumes. Phase two was of equal size and Xypex coatings were again specified, while the digesters, clarifiers and pump station utilized the immediate waterproofing and protection benefits of Xypex Admix C-1000. A total of 400,000 lbs. of Xypex was used.



WASTEWATER TREATMENT PLANTS



Bailonggang Wastewater Treatment Plant

 *Shanghai, China*

All internal concrete faces of the eight digesters were treated with Xypex Concentrate. In areas where anaerobic activity and a highly aggressive chemical environment were anticipated, an acid-resistant lining was installed. Xypex was applied to these specific areas as well, not only to provide secondary protection for the concrete but also to enhance the performance and durability of the primary acid-resistant lining.



Subotica Wastewater Treatment Plant

 *Subotica, Serbia*

An upgrade and extension of the Subotica WWTP was carried out in 2008. Xypex Crystalline Technology was used in the rehabilitation of aeration tanks where leakage was occurring due to cracking and other concrete defects. Cracks larger than 0.3 mm were repaired with Xypex Patch'n Plug, followed by a two-coat application of Xypex Concentrate and Modified over the entire surface of the tanks.

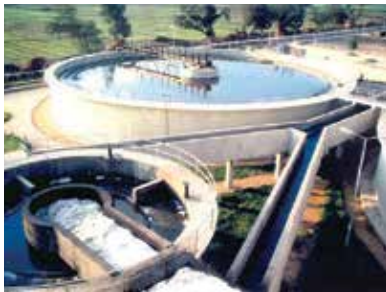

Shebin El Koum Sewage Station

 *Cairo, Egypt*

Over 35,000 m² of concrete at this large wastewater treatment plant in Cairo were waterproofed and protected with the Xypex crystalline waterproofing system (two coat application of Xypex Concentrate and Modified).



Pine Creek Wastewater Treatment Plant

 *Calgary, Alberta, Canada*

Xypex Concentrate and Modified (180,000 lbs.) were used to waterproof and provide chemical protection for the first phase of this major wastewater treatment facility (400,000 sq. ft.), while Xypex Admix C-500 was incorporated into the 75,000 sq. ft. slab.



Panama City Wastewater Treatment Plant

 *Panama City, Panama*

Construction of Panama City's WWTP, the first in the country, was completed in 2012. Located on the outskirts of the capital, the main purpose of the plant is to clean up the Bay of Panama by treating effluents before they are discharged. Xypex Concentrate and Patch'n Plug were used to repair and waterproof the large digester tanks.

WASTEWATER TREATMENT PLANTS



Alegria Wastewater Treatment Plant

 *Rio de Janeiro, Brazil*

Xypex Concentrate and Modified were spray-applied to all foundation walls and slabs of this wastewater treatment facility, the largest of seven plants that serve the city of Rio de Janeiro.



Bogota Wastewater Treatment Plant

 *Bogota, Colombia*

This is the first of three Bogota wastewater treatment plants to be treated with Xypex products. More than 5,000 kg of Xypex products were used to waterproof the structures. Xypex Patch'n Plug was also used to repair defects and stop water leakage in the concrete before application of the coating system.



Witwatersrand Gold Fields: Acid Mine Drainage

 *Witwatersrand, South Africa*

Xypex products were used to waterproof the concrete, protect reinforcing steel, and enhance the durability of this structure – a treatment facility designed to prevent the penetration of acid mine water and the extremely acidic ground water that contains heavy metals, arsenic, and other contaminants from the gold mining process. The Witwatersrand Basin holds the world's largest known gold reserves.



Seneca Wastewater Treatment Plant

 *Minnesota, USA*

Xypex products were used to repair the extensive cracking (5,000 linear feet) in pipe galleries at the old section of this plant. Xypex crystalline waterproofing system was also used to coat the chlorine contact chambers and other structures in the new section of the plant.



Santa Isabel Wastewater Treatment Plant

 *Santa Isabel, Puetro Rico*

The sulphate-reducing-bacteria tank (SRB) and the digester were treated with Xypex Concentrate (a total of 4,778 m²). Patch'n Plug was used to repair defects. A special sprinkler system was devised by the distributor to facilitate the spraying of water onto the treated areas to prevent drying during the curing process.

WATER TREATMENT PLANTS

The structural integrity of holding tanks in water treatment plants depends entirely on the protection of steel reinforcement from corrosion. Inadequate waterproofing, cracking, joint-failure, and chemical attack are problems that will result in the deterioration of concrete. The consequences are costly rehabilitation and significantly reduced service life. Whether used for new construction or the rehabilitation of water treatment structures, Xypex has gained an exceptional reputation for resisting extreme hydrostatic pressure, chemical attack and protecting the structural integrity of concrete.



WATER TREATMENT PLANTS



Raccoon Creek Water Treatment Plant

Summerville, Georgia, USA

Raccoon Creek Water Treatment facility is a conventional surface water treatment plant. Raccoon Creek is capable of producing up to 5.5MGD with a daily average of 2.5MGD.

Xypex Megamix II (306,000 lbs.) was used to rehabilitate the Raccoon Creek Water Treatment Plant in Summerville, GA. An engineering study determined that the superior bonding, chemical durability, and high strength of Megamix II would completely repair the structure's deteriorated concrete and bring it up to EPA standards. The rehabilitation option was good economic news; its cost of \$1.25 million was obviously preferred to the estimated \$25 million to fully replace the structure.

This 50-year-old WTP was in fact so deteriorated because of years of chemical attack, it was questionable as to whether repair, instead of full replacement, was even possible especially in light of the ever-higher environmental demands. The engineering study was therefore necessary and Xypex Megamix II was deemed the preferred option. Scheduling was an issue because the communities surrounding this facility (which processes 6 million gallons of water per day) were dependent on its continuous operation.



Megamix II made this possible, facilitating a three-phase construction schedule that enabled reconstruction without interrupting the water treatment process. Megamix II was used specifically on the flocculation tanks and sedimentation basins. Xypex Megamix I and Concentrate were used on the exposed exterior walls and on the interior surfaces of the filter tanks. Xypex Concentrate and Modified were applied to the vertical surfaces and soffits of the numerous walkways and Xypex FCM 80 was applied to the surface of walkways separating the individual tanks.

WATER TREATMENT PLANTS



Narva Water Treatment Plant

 *Narva, Estonia*

Xypex Admix C-1000 NF was used in 20,000 m² of concrete to waterproof and protect the circular reservoirs - essential elements in this water treatment complex. The project, in the third phase of a long-term investment plan, is designed to improve drinking water quality by treating raw water from the Narva River. In addition Xypex Patch'n Plug was used to fill tie holes and repair concrete defects.



Cardedeu Water Purifying Plant

 *Cardedeu, Spain*

This plant supplies Barcelona and other area towns with drinking water. The filter channels of this water purification facility were repaired and waterproofed with Xypex products.



Alyeska Pipeline Water Treatment Facility

 *Valdez, Alaska, USA*

The ballast water from the super-tankers that take on oil at Valdez is treated at this site. Xypex Concentrate was applied to the two final water-purifying tanks. After purification is complete, the water is pumped back into the ocean.



Winneba Waterworks

 *Winneba, Ghana*

This plant consists of a raw water intake and stage pump in the Ayensu river and two conventional treatment streams. All cracks in the filtration tanks were repaired using Xypex Patch'n Plug followed by a two-coat application of Xypex Concentrate and Modified.



Capilano Seymour Filtration Plant

 *North Vancouver, British Columbia, Canada*

The plant is the largest filtration plant in Canada and incorporates the largest ultra-violet light disinfection system in the world. Xypex Megamix II was applied as a repair mortar to protect the slab areas where rebar is exposed to corrosion. Over 148,500 lbs. of Megamix II has been applied. Xypex Concentrate was also used to fill tie holes and waterproof and protect the external walls of the tanks.

WATER TREATMENT PLANTS



Harry Tracy Water Treatment Plant

 *San Bruno Area, California, USA*

The Xypex-treated, 11 million gallon water reservoir at this water treatment plant is the last stage in the water’s journey from the Sierra Nevada Mountains before reaching the population of San Francisco. The inside of the tank was waterproofed and protected by a two-coat application of Xypex Concentrate and Modified (approximately 100,000 ft²).



Mao Point Water Treatment Plant

 *Santa Cruz de Mao, Dominican Republic*

This water treatment plant was built in the Dominican Republic by a large Brazilian construction company. Xypex was used to waterproof and protect a concrete area of 7,000 m². A combined total of 12 tonnes of Xypex Concentrate and Modified was spray-applied to slabs and walls.



Canóvanas Filtration Plant

 *Canóvanas, Puerto Rico*

Xypex Patch’n Plug was used to repair the structural defects of this filtration plant’s thickening tank, followed by a coating of Xypex Concentrate to the entire surface area making the concrete impermeable and protected. A later inspection by the municipality confirmed the success of the Xypex treatment.



Nice Water Treatment Plant

 *Nice, France*

The Xypex crystalline system was used extensively for the waterproofing and protection of concrete tanks and mechanical chambers at this water treatment facility in Nice.



Ilorin Water Treatment Plant

 *Ilorin, Nigeria*

A two-coat application of Xypex Concentrate and Modified was applied to both the two million and the one million gallon per day sedimentation tanks of this water treatment plant. Xypex Patch’n Plug was used to repair concrete defects prior to the coating application.

WATER HOLDING STRUCTURES

Water holding structures are about keeping water inside and Xypex Crystalline Technology, with its ability to resist extreme hydrostatic pressure, has been used extensively to waterproof and protect the concrete of a wide variety of water holding structures including reservoirs for potable water, filtration plants, swimming pools, and aquariums.

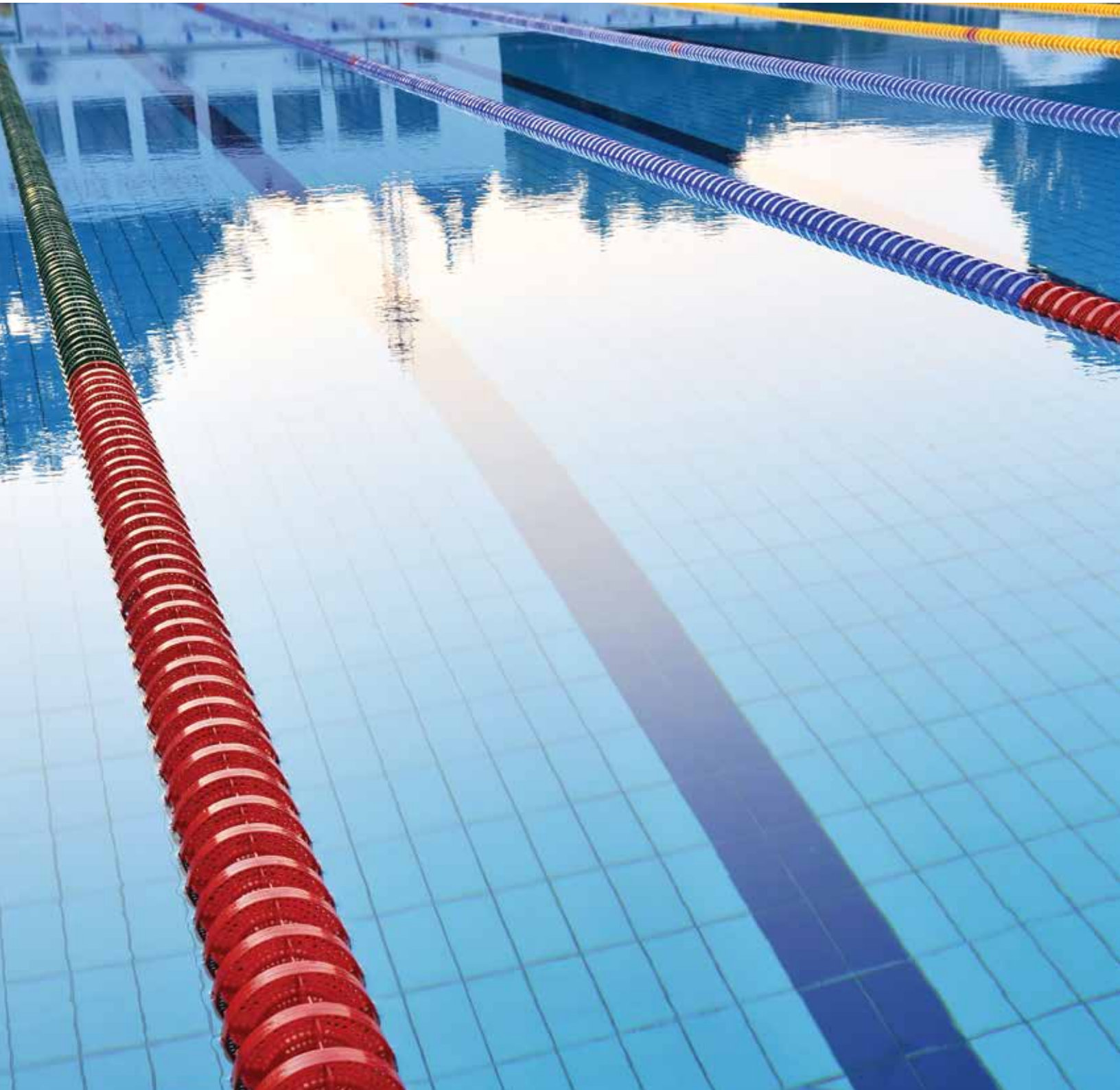

WATER HOLDING STRUCTURES



 **Ras Laffan Reservoir**
Qatar

The Ras Laffan Reservoir, part of the highly prestigious Ras Laffan C project, is designed to hold 63 million gallons and produce 275,000 m³ of potable water per day.

The Xypex two-coat system of Concentrate and Modified was used to waterproof and protect 37,999 m² of potable water tanks. The largest of these tanks takes 1½ years to fill. Xypex products were also used on the cooling tower of 11,300 m² and the sewage treatment plant of 377 m². Xypex Crystalline Technology was chosen for not only its ability to withstand high hydrostatic pressure, but to provide enhanced durability from chloride and sulphate attack in such an aggressive marine environment.

Ras Laffan C is one of the most prestigious projects in the Middle East and is the largest integrated water and power plant in the country, providing 30% of Qatar's electricity and 20% of its potable water. This facility also provides electricity to other Gulf States through a regional grid.



WATER HOLDING STRUCTURES



San Diego Zoo

 *San Diego, California, USA*

This polar bear tank was treated with both Xypex Concentrate and Modified at an application rate of 1.5 lbs./sq.yd. The Xypex technology provided an effective, environmentally safe waterproofing system for the tank.



Gefion Fountain

 *Copenhagen, Denmark*

After removal of the statue and four pool slabs, new slabs were cast with Xypex Admix blended into the concrete mix. The Xypex coating system (Concentrate and Modified) was then applied to the existing pool walls, while Xypex Concentrate and Patch'n Plug were applied to both the positive and negative sides of the reservoir under the pool house.



Melbourne Aquarium

 *Melbourne, Australia*

The below-ground aquarium tanks and viewing areas (adjacent to the Yarra River) exhibited leakage in various areas due to cracks and defective joints. All leakage was eliminated by using the Xypex concrete repair system (Concentrate and Patch'n Plug).



One & Only Resort Pool

 *Cape Town, South Africa*

Xypex products were specified to waterproof and protect various areas of this One & Only Resort project, including two undersea tunnels, lift shafts, health spa pools, day water tank, penthouse swimming pool and the main one-million liter swimming pool (pictured here). Four Xypex products were used: Admix C-1000, Concentrate, Modified and Patch'n Plug.



NASA Neutral Buoyancy Pool

 *Houston, Texas, USA*

Xypex Patch'n Plug (White) was utilized to seal all joints prior to applying Xypex Concentrate (White) to waterproof the entire interior surface of the pool (approx. 50,000 sq. ft.). This watertight pool provides a weightless environment to test space lab components and train astronauts for life and work in space.

WATER HOLDING STRUCTURES



Comodor Rivadavia Aquaduct

 *Chubut Province, Argentina*

Xypex’s unique crystalline technology was used to waterproof and protect tanks and pump stations of this 223 km aqueduct. Installation included repair of all defects, construction joints and tie holes with Xypex Patch’n Plug, followed by a two-coat application of Xypex Concentrate and Modified.



Portal Das Rosas Elevated Reservoir

 *Limeira, Brazil*

All cracks and other water leakage points were treated from the external side of this elevated reservoir using Xypex Patch’n Plug and Concentrate. The application was performed without any stoppage to the general operation of the reservoir.



Aquacentrum Barrandov

 *Prague, Czech Republic*

Aquacentrum is a large swimming complex in Barrandov, a neighbourhood of Prague. This aquapark includes a 25-meter pool, long waterslides and an outdoor pool and play area. Approximately three tonnes of Xypex Admix C-1000 was used to waterproof and protect the slab and walls of the large swimming pool, and Xypex Patch’n Plug was applied to 200 m of joints.



Pool & Spa House

 *Clarus, Bermuda*

The Xypex crystalline waterproofing system was used throughout the swimming pool and spa areas of this exclusive Bermuda property. Application included use of Xypex Admix C-1000, Concentrate and Modified.



Aquaria KLCC

 *Kuala Lumpur, Malaysia*

Located within the Kuala Lumpur Convention Centre, Aquaria KLCC is a world-class aquarium that houses over 250 different species. Xypex was used to protect the inhabitants against the alkalinity of the concrete while also protecting various concrete structures against chloride attack. The application included Xypex Admix C-Series and a two-coat system of Xypex Concentrate and Modified.

BELOW GRADE

More often than not, Xypex waterproofing takes place underground where concrete requires protection against any number of potentially invasive water forces. Below grade, the crystalline technology of Xypex products resists hydrostatic pressure and protects against reinforcing steel corrosion and sulfate attack.

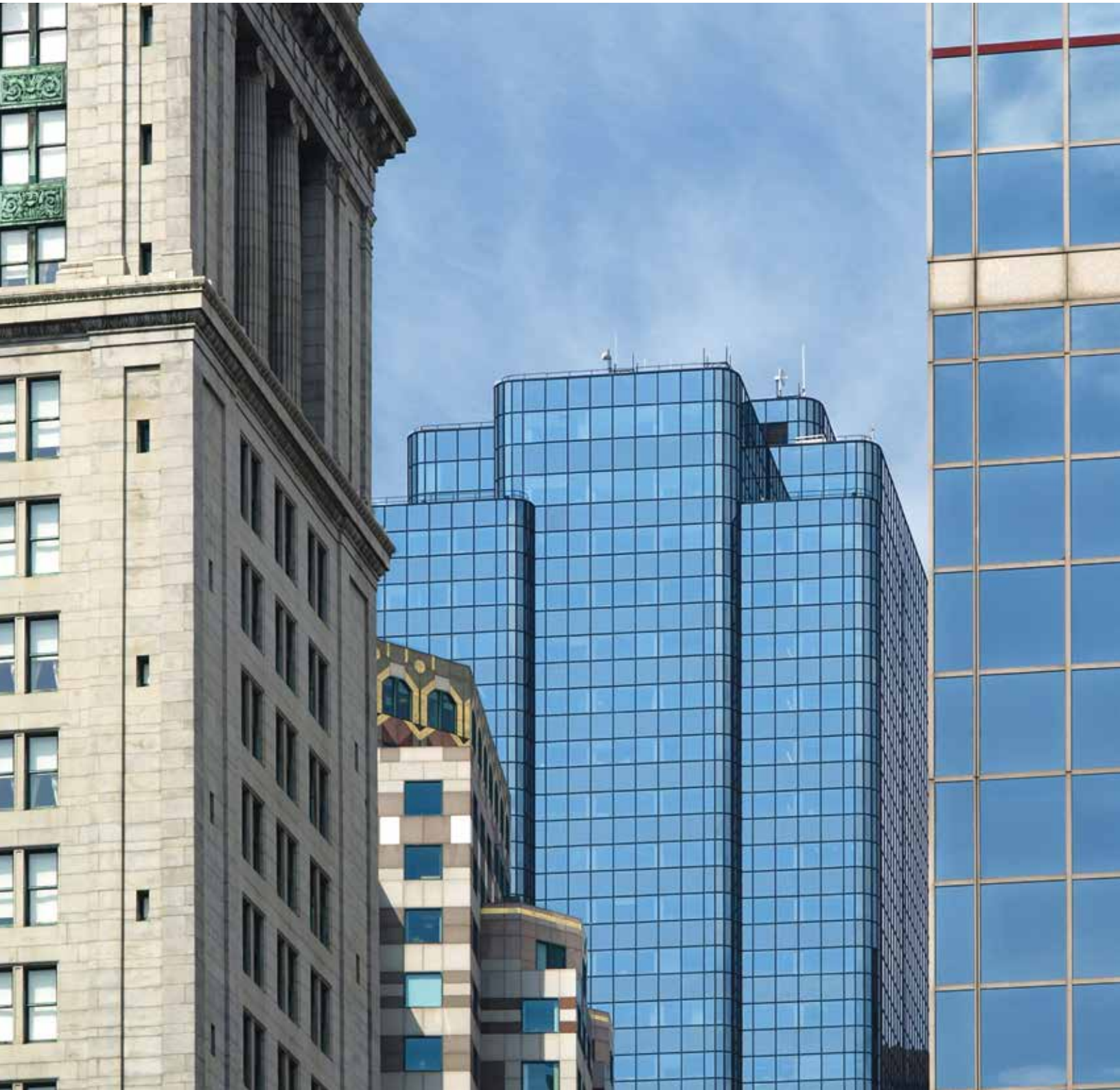

BELOW GRADE



 **Willis Building**
London, United Kingdom

Changing the London skyline, The Willis Building is the fourth tallest building in the city. Its progressive environmental strategy surpasses statutory carbon reduction targets and meets the highest standards for sustainability. Over 15,000 m³ of concrete was used in its construction.

This 28-storey skyscraper, opposite Lloyd’s in the heart of London’s financial district, is the new headquarters of the global insurance broker, Willis Group Holdings. Designed by world-renowned architects Foster + Partners, the building won the 2007 New City Architecture Award for its unique architectural form and contribution to the streetscape and skyline of the City of London. The project is significant in both urban and environmental terms. Most of the material from demolition of the previous building was recycled and crushed for use in the 38-meter-deep foundations.

Xypex Admix C-1000 NF was used to waterproof and protect the below-grade slab and elevator pits. Xypex Concentrate Dry-Pac was then installed in all floor-wall joints followed by a slurry coat application of Xypex Concentrate.



BELOW GRADE



Bank of Tanzania

 *Dar es Salaam, Tanzania*

Two coats of Xypex Concentrate were applied to exterior vault walls and to the floor slab. Before application of the second coat, cold joints around the perimeter of the slab were routed out, treated with a slurry coat of Xypex Concentrate and then filled with Xypex Patch'n Plug.



The Esplanade Theatres on the Bay

 *Singapore*

This project involved waterproofing the below-grade foundation that would be subjected to significant hydrostatic pressure and a harsh marine environment. The use of Xypex Admix accelerated the construction schedule and resulted in a time saving of more than two months: a real example of value engineering.



Bank of China

 *Beijing, China*

A high water table required the specification and use of Xypex products to waterproof and protect the basement, cash vaults, service rooms and auditorium of this IM Pei-designed Bank of China headquarters. The Xypex system was also used on the raft foundation walls and slab.



Ratusz Metro Station A-15

 *Warsaw, Poland*

The Xypex crystalline system was used to waterproof and protect all concrete in the Ratusz Metro subway station, including floor slabs, foundation walls, non-structural walls and ceilings.



Cathedral of Christ the Savior

 *Moscow, Russia*

Xypex Concentrate and Modified were applied to the plaza deck over the chapel, parking structure and pump station. Xypex FCM repair system was used at the junction of the plaza and the brick walls. Cracks in the below grade pipe gallery were repaired using Xypex Patch'n Plug and FCM followed by a coat of Xypex Concentrate (White).

BELOW GRADE



Dewan Perdana Feldar

 *Kuala Lumpur, Malaysia*

Xypex Admix C-2000 NF was used in over 7,500 m³ of concrete, making up the one meter thick base slab and retaining walls of two underground car parks, to ensure water tightness. A total of 3,400 kg of Xypex Concentrate and Modified were also applied to other concrete structures at this landmark complex.



The Waterfront Centre

 *Vancouver, British Columbia, Canada*

Ten thermal storage tanks, ten elevator pits and four sump pits were waterproofed with Xypex products at this hotel and office complex on Vancouver's harbour waterfront. The total area treated was approximately 7,450 m² (80,000 sq. ft.). In addition, Xypex Concentrate and Patch'n Plug were used to repair approximately 1,200 meters (4,000 lin. ft.) of construction joints.



The Sands Casino

 *Macau*

The foundation of this casino complex, designed by the Paul Steelman Design Group, would be subjected to high hydrostatic pressure. Xypex Admix was then specified and used to waterproof over 10,000 m³ of the concrete foundation, while Xypex Patch'n Plug and Concentrate were used to repair cracks and joints.



National Bank of Ethiopia

 *Addis Ababa, Ethiopia*

A two-coat system (Xypex Concentrate and Modified) was applied to interior basement area, underground vaults, and two-level parking structure. The roof slab of the above-ground parking structure was also treated with Xypex products.



Benziger Family Winery

 *Glen Ellen, California, USA*

Xypex Admix, with a colored pigment, was specified and used to stop water penetration into the underground areas and wine-storage caves at this well-known family winery in the Sonoma wine country. Xypex Patch'n Plug was also used to repair large cracks.

BELOW GRADE



The Shard

 *London, United Kingdom*

At 95 storeys, the Shard is the tallest building in the UK – a construction project that required the largest continuous concrete pour in UK history. Xypex Admix was used to waterproof and protect areas of the basement as well as the capping beams and lift pits on various floors. Xypex was also used to waterproof the Shangri La Hotel swimming pool and spa area on the 52nd floor. In all, 10 tonnes of Xypex Admix C-1000 NF was used to treat 1,500 m³ of concrete.



Saifee Hospital

 *Mumbai, India*

The Xypex crystalline waterproofing system was applied to the floors and retaining walls of the three-level basement at this major multi-specialty hospital overlooking the Arabian Sea. The Xypex coating application was performed on the negative side (against the water pressure).



The Municipal House

 *Prague, Czech Republic*

The Municipal House, constructed between 1905 and 1911, is one of Prague's cultural and architectural treasures. During its complete restoration in 1996, Xypex products were used to waterproof below-grade areas of the structure, including reservoirs and utility tunnels.



Garanti Bank Technology Campus

 *Istanbul, Turkey*

This project is a commercial banking complex with a large data center incorporated into it. The foundation is a tank foundation with Xypex Admix, Modified and Concentrate being used. The walls contain Xypex Admix C-1000 at approximately 2.5% dosage and Xypex Concentrate slurry is used at all cold joints. The project will use approximately 70,000 m³ of concrete in total.



ION Orchard

 *Singapore*

Selected once again by Penta-Ocean Construction, Xypex Admix C-1000 NF was used to waterproof and protect the critical substructure – the basement and roof slabs – of this large and prestigious retail mall. Using Xypex Admix in the mix design also provided the added benefit of considerable production scheduling control. Xypex Concentrate was used to waterproof construction joints.

TUNNELS

Tunnels serve many purposes such as transporting people or goods, accessing minerals from deep in the earth, or providing conduits for electrical and telecommunications services. Proper waterproofing of tunnels is one of the most cost effective ways to enhance safety and function as well as increase the service life of these structures. Xypex Crystalline Technology, and its ability to resist extreme hydrostatic pressure, aggressive soils and traffic contaminants, is used the world-over to waterproof, protect and enhance the durability of tunnels.



TUNNELS



 **Washington DC Metro System**
Washington, D.C., USA

Metrorail, commonly called Metro, is the second-busiest rapid transit system in the United States in number of passenger trips. Since opening in 1976, the Metro network has grown to include five lines, 86 stations, and 106.3 miles (171.1 km) of track.

Xypex products were specified by Bechtel Corp. and the Washington Metropolitan Transit Authority for use at various locations of the metro area subway system, including sections in central Washington D.C., Bethesda (Maryland), Chevy Chase (Maryland) and Alexandria (Virginia). Areas of application included tunnel sections, large shotcrete vaults, passageways, mechanical rooms, equipment vaults, elevator shafts and various areas in metro stations.

The Xypex system was not only used to treat large surface areas but was also used extensively for the repair of severe leakage problems caused by concrete defects and exposure to strong hydrostatic pressures.



TUNNELS



Susten Pass Road Tunnel

 *Innertkirchen, Switzerland*

The concrete of this 1949 tunnel deteriorated over time resulting in substantial water seepage through cracks and degraded areas. With freezing temperatures this created a traffic hazard. New concrete replaced the old and the Xypex coating system (Concentrate and Modified) was used to waterproof and protect it.



São Paulo Metro System

 *São Paulo, Brazil*

Two subway stations were treated with the Xypex Crystalline Technology to prevent water penetration. First, cracks were repaired using Xypex Concentrate Dry-Pac, followed by a two-coat application of Xypex Concentrate and Modified. An additional 38 stations in Sao Paulo are to be waterproofed and protected with Xypex products.



Vuoli Harbour Tunnel

 *Helsinki, Finland*

Xypex Admix C-1000 NF was used to waterproof and protect the 50 mm thick shotcrete lining of this rail and two road tunnels located under the Helsinki harbor. The concrete mix design used 470 kg of Portland cement per cubic meter, and the Xypex Admix NF was dosed at 1.1% (5 kg) per m³.



Delhi Metro

 *Delhi, India*

Xypex Admix C-2000 NF was dosed into 40,000 m³ of concrete to waterproof and protect the underground stations' base slabs in the Delhi Metro system. Using Xypex Admix provided the additional benefit of eliminating the installation time and inconvenience typical of barrier systems. This resulted in much-improved production scheduling.



Ankara Subway

 *Ankara, Turkey*

Xypex Patch'n Plug was used to repair 11,000 meters of cracks and construction joints in this subway tunnel, stopping all water ingress. Xypex Concentrate and Modified were then applied to surface areas to waterproof and protect the concrete.

BRIDGES

Concrete durability is key in the building of bridges. Xypex's unique crystalline technology addresses the many problems that age and aggressive environmental conditions, such as harsh weather and constant traffic, impose on these concrete structures.



BRIDGES



Second Orinoco River Bridge

Ciudad Guayana, Venezuela

The Orinoco and its tributaries constitute the northern most of South America’s four major river systems. The bridge is a 3.2 km (2 miles) long road-rail crossing, carrying four lanes of highway traffic separated into two carriageways by a single railway track in the centre.

The general contractor, Constructora Norberto Odebrecht, S.A., due to concerns regarding water seepage and the possibility of corrosion of the reinforcing steel, utilized Xypex Concentrate to waterproof and protect the concrete base for the railway. Odebrecht was confident in Xypex’s crystalline technology having used it successfully on the metro project in Caracas. Prior to the Xypex application, there was already obvious leakage from the concrete.

This problem ceased after the application of over 63,000 lbs. of Xypex Concentrate to the concrete base and walls underlying the rail track.

XYPEX[®]

products used

Concentrate

BRIDGES



Aomori Bay Bridge

 *Aomori, Japan*

The main beams of the precast girder box were exposed to salt corrosion damage from the ocean. Xypex Crystalline Technology, because of its resistance to effects of marine environments, was applied to the bottom plates including plates of the main girder, horizontal keyways, non-expansion vertical construction joints, exterior walls and the top deck slab.



Kaunas Bridge

 *Kaunas, Lithuania*

The support columns of the old bridge were treated with Xypex Concentrate. The Xypex coating system was also used on the entire undersides of the two new bridges.



Skala - Nemsova Motorway Bridge

 *Slovakia*

This motorway concurrently forms a flood barrier to the Vah River. A two-coat application of Xypex Concentrate and Modified was used to waterproof the run-off channels and pits where highway water, carrying oils and chemicals are collected. The columns on several of the bridge sections were also treated with a two-coat Xypex application.



Bedaling Expressway Overpass

 *Beijing, China*

The Bedaling Expressway, located outside of Beijing and leading to the Great Wall, includes 4 overpasses which were waterproofed using Xypex Concentrate and Patch'n Plug.



M7 Koröshegyi Bridge

 *Koröshegyi, Hungary*

The bridge parapets and storm-water drainage system required protection from destructive elements such as exhaust gasses, de-icing salts, etc. Because of this, a two-coat application of Xypex Concentrate and Modified was used to waterproof and protect both the concrete and the reinforcing steel.

MARINE STRUCTURES

Xypex Crystalline Technology protects concrete structures in marine environments – structures that are exposed to the damaging effects of seawater, chlorides and other aggressive elements. Preventing corrosion of reinforcing steel and consequential concrete degradation has made Xypex an important treatment for a variety of marine installations including wharfs, bridge pilings, locks, desalination conduits and seawalls.

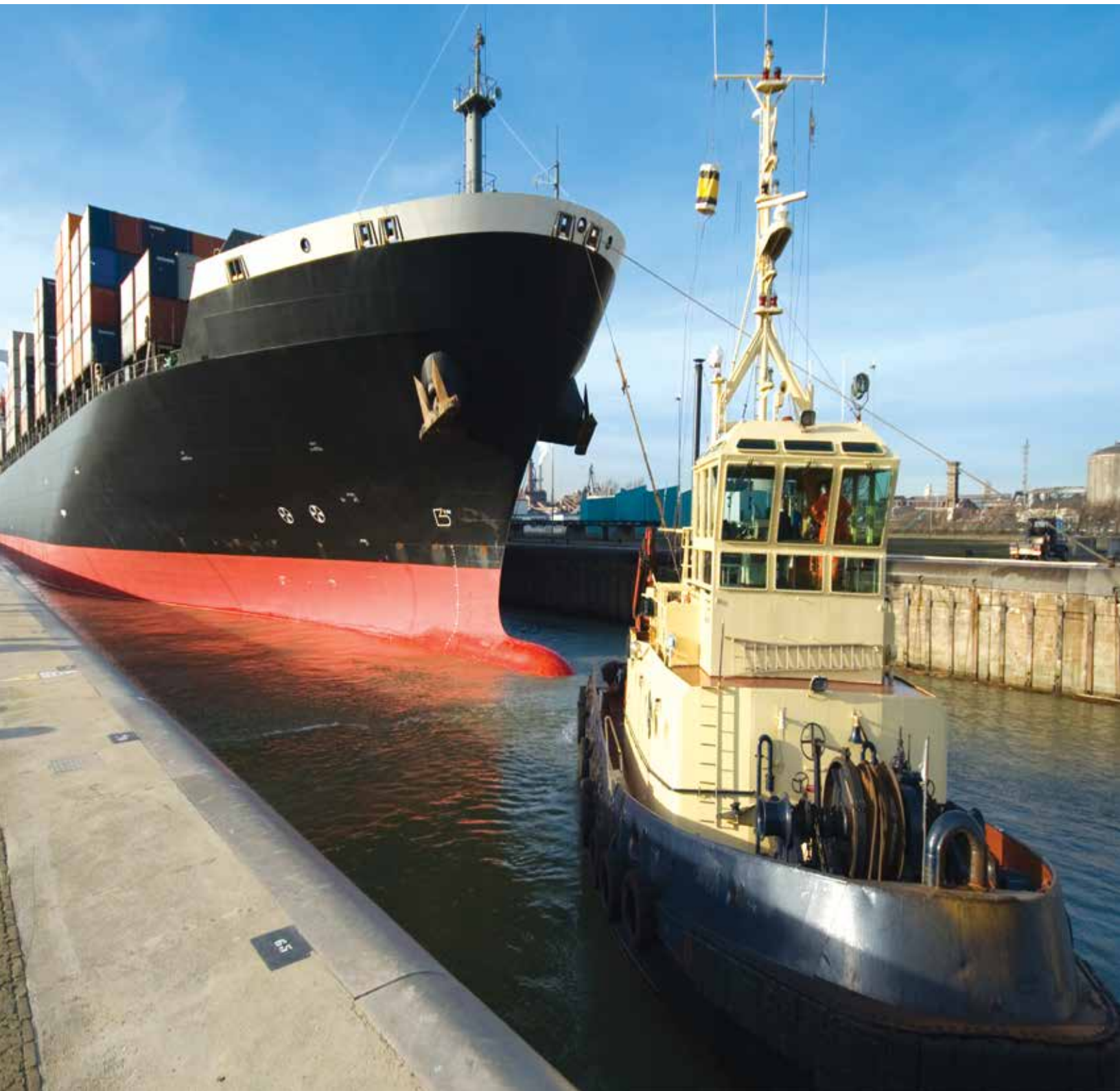

MARINE STRUCTURES



Panama Canal
Panama

Since 1914, the Panama Canal has been a conduit of world importance, providing a link between two great oceans, a passageway annually for more than 14,000 vessels carrying more than 200 million tonnes of cargo.

Since 1995, Xypex products have been integral to an on-going program of upkeep and refurbishment of the canal, the revitalization of concrete that has stood the grueling test of more than 80 years of continuous service.

Xypex Admix has been used to re-surface the 30-foot diameter culverts which pump water into and out of the locks. After prolonged use, the walls of the culvert became rough, with exposed aggregate causing turbulence and a slow fill and dump cycle. By smoothing out the surface of the concrete with an inch-thick Xypex Admix treated shotcrete, which also reduced water loss, the locks can fill and empty seven minutes faster on each cycle. This permits the passage of more ship traffic through the canal system.



MARINE STRUCTURES



Sea Bus Docks

 *Vancouver, British Columbia, Canada*

The post-tensioned steel reinforcing cables of two large floating concrete docks were placed too close to the bottom surface, and therefore were exposed to salt corrosion. The docks were removed from the water and Xypex Concentrate was applied to the undersides. Following curing, they were placed back into the water and have exhibited no further corrosion.



Singapore Marina Barrage

 *Singapore*

The barrage consists of nine steel crest gates and spans the 350 meters wide Marina Channel, separating seawater from freshwater and acting as a tidal barrier. More than 7,000 kg of Xypex Megamix II were used to shape and protect the barrage gates. Megamix II was selected to meet the fine (1 mm) tolerance specifications and its ability to withstand the harsh marine environment.



Cronulla Marina

 *Sydney, Australia*

The concrete mix used at this marina included Xypex Admix C-2000 NF added at a dosage rate of 4 kg/m³, and was designed to achieve 32 MPa at 48 hours and 50 MPa in seven days. The two-tonne post-tensioned units of these floating concrete structures had to be lifted from their formwork 36 - 48 hours after casting.



Sempra Energy Natural Gas Terminal

 *Ensenada, Mexico*

More than 25,000 lbs. of Xypex Concentrate were used to protect the concrete from the harsh marine environment and the potential for deterioration due to chloride exposure. The breakwater is 1,300 meters long.



Anderson Point

 *Port Hedland, Australia*

Anderson Point is a berthing facility primarily intended for the export of 45 million tonnes per annum of iron ore from the Pilbara region of Western Australia to Asian markets. Xypex Admix C-Series was specified for all concrete elements of this facility to provide enduring protection for this vital structure.

DAMS

Dams, whether for hydroelectric production or water management, are all about water – keeping it secure and protecting the unique components that are engineered into every dam structure. Xypex Crystalline Technology has been specified worldwide for the waterproofing and protection of dams, including upstream and downstream faces, pipe galleries, discharge chambers and spillways.



DAMS

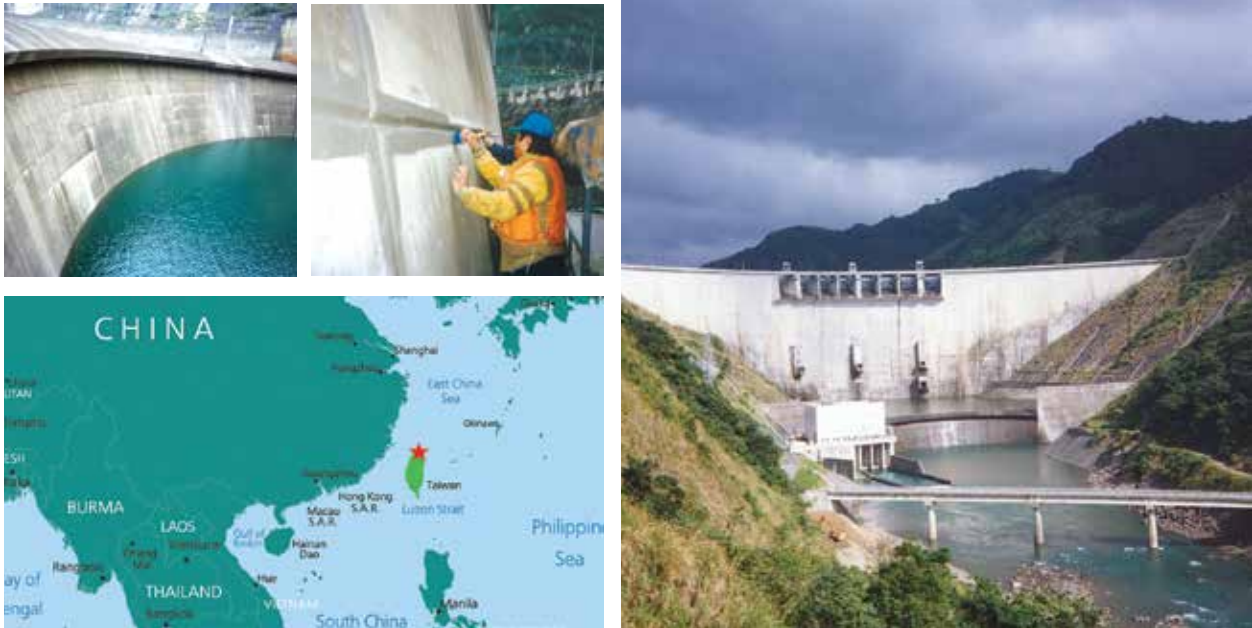

 **Fei Cuei Dam**
Hsin Tien, Taiwan

The Fei Cuei Dam, the largest concrete dam in Taiwan, is located 30 km south of Taipei City near the mouth of Beishi Creek. The Fei Cuei Reservoir provides the Taipei water supply region with a dependable source of water for domestic and industrial use. The dam and reservoir began operation in January 1979.

The Fei Cuei Dam is a three-centered double curvature with variable thickness arch dam and includes eight crest spillways, three sluiceways and one tunnel spillway. The dam is 122.5 m high and was built with 700,000 m³ of concrete. When water began seeping through the wall joints of the dam, The Water Conservation Bureau of Taiwan specified Xypex to solve the problem.

The Xypex two-coat application of Concentrate and Modified eliminated all seepage, waterproofed the structure, and thereby prevented oxidation of the reinforcing steel.



DAMS

Ogrezeni Dam Spillway

 *Bucharest, Romania*

This dam structure is located on the Arges River, 25 km west of Bucharest. The reservoir was created to provide added security and quality to the water supply. Cracks and joints (275 meters) on the spillway surface were repaired using Xypex Patch'n Plug to prevent leakage into the service gallery. A coat of Xypex Concentrate was then applied over the repaired areas.



Jinghong Dam & Hydropower Station

 *Jinghong, China*

The Jinghong Dam on the Lancang (Mekong) River is a 108-meter high, 700-meter long gravity dam composed of roller-compacted concrete. After extensive testing, Xypex was selected for the repair and waterproofing of the upstream face of the dam. The project required a combined 107,000 kg of Xypex Admix, Concentrate and Patch'n Plug.



Huaylacancha Dam

 *Huancayo, Peru*

Xypex Patch'n Plug was used to repair cold joints after the parge surface coat was removed from the upstream and downstream faces of this dam. Both Xypex Concentrate and Modified were then used to waterproof the upstream face, while a single coat of Concentrate was used on the downstream face.



Zawada Mill Dam

 *Zawada, Poland*

Extreme hydrostatic pressure was causing leakage through the concrete in the pipe gallery. Xypex Concentrate was applied on all interior surfaces to prevent further water infiltration.



Dau Tieng Dam

 *Tay Ninh Province, Vietnam*

After a successful trial application in 1997, Xypex products were specified and used to waterproof the upstream discharge chamber (400 m²) of this dam. A Xypex technical representative provided on-site support to ensure proper application.

POWER & UTILITIES

Ensuring the integrity of concrete structures and, at the same time, protecting the surrounding environment is critical in the power industry. Xypex Crystalline Technology products have made an important contribution in waterproofing and protecting hydroelectric facilities, desalination plants, thermal and nuclear power stations and cooling tower basins.



POWER & UTILITIES



 **J-Parc Synchrotron**
Tokai-mura, Japan

The Japan Proton Accelerator Research Complex (J-PARC) is a high intensity proton accelerator using MW class high power beams up to 50 GeV – the highest beam power of any accelerator in the world.

The site is subject to a high water table and is adjacent to the ocean – presenting contamination challenges that could affect the accelerator’s sensitive functions.

Xypex Crystalline Technology, because of its waterproofing effectiveness, resistance to the marine environment, and its compatibility with the radioactive process, was specified by major firms involved in the construction coalition that built the accelerator – a 3.5 km circular tunnel encased in concrete up to five meters thick. Xypex Concentrate was used on the mud slab and Xypex Dry-Pac was applied to the preformed horizontal keyways and non-expansion vertical construction joints. In a two-coat application, sixty tonnes of Xypex Concentrate was then spray-applied to the exterior walls and roof slab, covering a total area of 50,000 m².

XYPEX[®]
products used

Concentrate





Wolsung Nuclear Plant

 *Gyeongju, North Gyeongsang Province, South Korea*

Xypex products were used to repair cracks and coat surface areas in the intake and discharge conduits of this nuclear plant. The conduits are utilized in the process of cooling water.



Bogong Power Station

 *Bogong, Mt. Beauty, Australia*

Xypex Admix C-Series was specified for use in 12,000 m³ of concrete for this new power station development, designed to provide an additional 140 MW to the Kiewa hydroelectric scheme. The Xypex system was used to enhance long-term durability and provide added waterproofing integrity for this vital infrastructure development.



EGAT Bang Pakong Power Plant

 *Bang Pakong, Thailand*

The cooling towers at this power plant had been adversely impacted by chloride ions. Based on past experience, EGAT discovered that previous barrier systems provided limited protection and only for a 3 - 5 year period. Xypex Crystalline Technology was therefore recommended and used by EGAT Ratchaburi because of its previous successful use and long-term effectiveness on other EGAT projects.



Transformer Stations

 *Ljubljana, Slovenia*

The chemical and chloride protection ability of the Xypex Crystalline Technology was put to use in repairing the deteriorating concrete structure underneath the transformers at this electrical facility. Xypex Concentrate and Patch'n Plug were applied to three transformer stations to prevent oily substances leaching into the surrounding soil.



Shoiba Power & Desalination Plant

 *Red Sea, Saudi Arabia*

This facility is considered one of the largest desalination plants in the world. The Xypex coating system was used to waterproof the pump house located below sea level and the concrete canals for intake and outtake of the sea water.

PRECAST

Using the Xypex Admix C-Series of products, precast manufacturers can add value to their products. Xypex Admix is blended into the concrete at time of batching enabling companies manufacturing precast products such as manholes, box culverts, pipe, architectural panels and highway median barriers to waterproof and protect their products before they leave the plant.



PRECAST



 **Jacksonville Electric Authority Wharf**
Jacksonville, Florida, USA

The Jacksonville Electric Authority, supplier of electricity and water to the city of Jacksonville, is the operator of this wharf that serves as the receipt point for fuel oil used by their electrical plant. Two pipelines extend from the wharf to storage tanks at the rear of the plant.

During construction, a primary concern was maintaining the integrity of the concrete used in the pile driven piers. Engineers Black & Veatch and the contractor, Gate Concrete Products were familiar with the ability of Xypex Crystalline Technology to self heal any micro-cracks that might occur from the pile driving process and specified Admix C-1000 NF accordingly. Xypex Admix was also used in the U-beams and on the wharf's slab.

Overall, 160,000 lbs. (73,000 kg) of Xypex Admix C-1000 NF at a dosage rate of 1.5% of the cement content was blended into the concrete to provide waterproofing and chemical protection from the harsh marine environment.

XYPEX
 products used

Admix C-1000 NF



PRECAST



Pennsylvania Turnpike

Pennsylvania, USA

In a four year program that involved the use of more than 1.5 million pounds of product, Xypex Admix was used in 150 miles of precast concrete barriers and 5 miles of retaining walls that serve the busy northeast U.S. connector.



Vicksburg Sewer Main

Mississippi, USA

Xypex Admix C-1000 was added to the concrete pipe at a rate of 3% by weight of Portland cement. The Xypex additive was selected over a traditional protective coating, to provide chemical protection and to prevent water ingress and egress.



Precast Septic Tanks

Nanaimo, British Columbia, Canada

To ensure protection from an aggressive environment, Xypex Admix C-500 was added to the concrete mix at time of batching for these precast septic holding tanks.



Sorek Desalination Plant

Tel Aviv, Israel

Sorek Desalination Plant is the world's largest seawater desalination plant. The facility uses seawater reverse osmosis (SWRO) process to provide water to Israel's water carrier system. There were two phases to this project. Phase One: precast pipes (2.5 m - 3.1 m dia.) / Phase Two: cast-in-place tanks. 112,000 kg of Admix C-500 NF was used in precast pipe sections for a total length of 9,700 m.



Hisense Arena

Melbourne, Australia

Xypex Admix C-1000 NF was blended into the concrete mix to waterproof and protect the precast bleachers for this multipurpose stadium (formerly named the Vodafone Arena). The seating design of this stadium is stunningly innovative and the contractors used the latest technology to ensure that the arena would accommodate a wide range of functions.

Beingthere™

Xypex products and services are available in over 80 countries. *Being There* means we know the territory and that knowledge benefits our customers. We look forward to your inquiries.



Find a Xypex distributor in your area:

- | | | | |
|---------------------------|-------------|----------------|-------------------------------|
| - ARGENTINA | - ESTONIA | - MACAU | - SERBIA |
| - AUSTRALIA | - ETHIOPIA | - MACEDONIA | - SINGAPORE |
| - AUSTRIA | - FINLAND | - MALAYSIA | - SLOVAKIA |
| - BANGLADESH | - FRANCE | - MEXICO | - SLOVENIA |
| - BARBADOS | - GEORGIA | - MONTENEGRO | - SOUTH AFRICA |
| - BERMUDA | - GERMANY | - NEPAL | - SPAIN |
| - BOSNIA &
HERZEGOVINA | - GHANA | - NETHERLANDS | - SRI LANKA |
| - BRAZIL | - GREECE | - NEW ZEALAND | - SWITZERLAND |
| - BULGARIA | - HONG KONG | - NICARAGUA | - TAIWAN |
| - CANADA | - HUNGARY | - NIGERIA | - TANZANIA |
| - CHILE | - ICELAND | - NORWAY | - THAILAND |
| - CHINA | - INDIA | - PAKISTAN | - TURKEY |
| - COLOMBIA | - INDONESIA | - PANAMA | - UKRAINE |
| - COSTA RICA | - IRAN | - PERU | - UNITED ARAB EMIRATES |
| - CROATIA | - IRELAND | - PHILIPPINES | - UNITED KINGDOM |
| - CYPRUS | - JAPAN | - POLAND | - UNITED STATES
OF AMERICA |
| - CZECH REPUBLIC | - JORDAN | - PORTUGAL | - VENEZUELA |
| - DENMARK | - KENYA | - PUERTO RICO | - VIETNAM |
| - DOMINICAN REPUBLIC | - KOREA | - QATAR | - ZIMBABWE |
| - ECUADOR | - KUWAIT | - ROMANIA | |
| - EGYPT | - LATVIA | - RUSSIA | |
| | - LITHUANIA | - SAUDI ARABIA | |



13731 Mayfield Place, Richmond, BC, Canada V6V 2G9 Tel: 604.273.5265 Email: enquiry@xypex.com Web: www.xypex.com
Copyright © 2017 Xypex Chemical Corporation. All rights reserved. XYPEX is a registered trademark of Xypex Chemical Corporation.